



SUA FERRAMENTA

PREÇOS VÁLIDOS A PARTIR DE
01/04/2024



2024



CONJUNTOS DE FERRAMENTAS

7

CONJUNTOS DE FERRAMENTAS
CONJUNTOS DE CHAVES DE CAIXA
CAIXAS / MALETAS DE FERRAMENTAS
CONJUNTOS DE PONTAS
CONJUNTO DE CATRACAS MINI
CONJUNTO DE ADAPTADORES
KIT DE PONTAS
KIT DE CHAVES DE CAIXA
FERRAMENTAS COM ISOLAMENTO



FERRAMENTAS MANUAIS

37

CHAVES
SARGENTOS
CATRACAS
CHAVES DINAMOMETRICAS
BARRAS DE EXTENSÃO
CHAVES DE FENDAS
ALICATES
FERRAMENTAS DE INSPEÇÃO
MARTELOS
FERRAMENTAS DE CORTE
CINZÉIS
REBITADORES
FERRAMENTAS DE MEDIÇÃO
DIVERSOS



MOBÍLIA DE OFICINA

71

CARROS DE FERRAMENTAS
CONJUNTOS DE FERRAMENTAS
ACESSÓRIOS
MESAS DE TRABALHO
ARMAZENAMENTO
BANCOS / ESTRADOS
TORNOS / BIGORNAS



FERRAMENTAS ELÉTRICAS SEM FIO

101

APARAFUSAR
PERFURAR
LIXAR/POLIR
SERRAR
FERRAMENTAS ESPECIAIS
FERRAMENTAS ELÉTRICAS DE JARDINAGEM
BATERIAS / CARREGADORES
ACESSÓRIOS / CONSUMÍVEIS



LUZES

129

LÂMPADAS DE INSPEÇÃO
LANTERNAS DE CABEÇA
GAMBIARRAS
FOCOS LED
ILUMINAÇÃO DE CAPÔ
PIRILAMPAS
LÂMPADA DE TRABALHO
SINALIZAÇÃO
ACESSÓRIOS E PEÇAS DE REPOSIÇÃO



FERRAMENTAS PNEUMÁTICAS

145

APARAFUSAR
PERFURAR
CORTAR / SERRAR
LIXAR/POLIR
PISTOLAS DE AR
MANUTENÇÃO DE PNEUS
OUTROS
ENROLADORES DE MANGUEIRAS DE AR
MANGUEIRAS CONECTORES
ACESSÓRIOS E CONSUMÍVEIS



FERRAMENTAS DE IMPACTO

167

CHAVES DE CAIXA DE IMPACTO
ESPECIAL PNEUS
ADAPTADORES
PEÇAS SOBRESSALENTES DE CHAVES DE IMPACTO
ESPECIAL CAMINHÕES



CARROÇARIA

179

FERRAMENTAS PARA CARROÇARIA
RESTAURAÇÃO DE FARÓIS
SUBSTITUIÇÃO DE VIDRO
REPARAÇÃO DO CHASSIS
MOBÍLIA AUXILIAR
MANUTENÇÃO INTERIOR



TRAVÕES

193

REPOSICIONADORES
SANGRADORES DE TRAVÕES
MANUTENÇÃO



FERRAMENTA ESPECIAL

199

SISTEMA DE LUBRIFICAÇÃO
SISTEMA DE INJETORES
CILINDROS
EMBREAGEM
SISTEMA DE REFRIGERAÇÃO
SISTEMA DE AR CONDICIONADO
TRANSMISSÃO
SUSPENSÃO
ESCAPE
SISTEMA ELÉTRICO
REPARAÇÃO DE ROSCAS
MOTOS
EXTRATORES



FERRAMENTAS DE SINCRONISMO

243

FIAT/ALFA ROMEO
BMW/MINI
PSA
FORD
JAGUAR/LAND ROVER
JEEP/CHRYSLER

MERCEDES-BENZ
RENAULT/DACIA/NISSAN
OPEL/VAUXHALL
VAG
OUTRAS
FERRAMENTAS ADICIONAIS



ACESSÓRIOS DE LUBRIFICAÇÃO

301

BOMBAS DE ABASTECIMENTO DE COMBUSTÍVEL DIESEL
BOMBAS DE ABASTECIMENTO DE UREIA
BOMBAS DE ENCHIMENTO/EXTRAÇÃO
COLETORES DE ÓLEO
PISTOLAS DE SUCCÇÃO
BALDES DE COLEÇÃO DE ÓLEO
OUTROS



FERRAMENTAS HIDRÁULICAS

313

MACACOS HIDRÁULICOS DE RODAS
MACACOS TIPO GARRAFA
MACACOS DE MANIVELA
MACACO HIDRÁULICO TELESCÓPICO
CAVALETES
OUTROS
PORTA PALETES MANUAL
PRENSAS
GUINDASTES
MESAS DE ELEVAÇÃO
BASES DE ELEVAÇÃO



FERRAMENTAS ELÉTRICAS

327

ARRANCADOR
MANUTENÇÃO DE BATERIAS
MEDIÇÃO DE CORRENTE
INSPEÇÃO VISUAL
SOLDADORA
EQUIPAMENTO PARA OFICINA
CLIMATIZAÇÃO
TERMÔMETROS
OUTROS



ENERGIA RENOVÁVEL E MOBILIDADE DO FUTURO

341

CABOS PARA CARREGAR DE CARROS ELÉTRICOS
CARREGADORES DE CARRO ELÉTRICO
GERADOR DE ENERGIA
FERRAMENTAS COM ISOLAMENTO



ACESSÓRIOS DE OFICINA

347

ENROLADOR DE MANGUEIRA
ESCADAS
CARRINHOS E PLATAFORMAS



ACESSÓRIOS DO VEÍCULO

353

SINALIZAÇÃO
KITS DE EMERGÊNCIA
LÂMPADAS
KITS DE PRIMEIROS SOCORROS
SEGURANÇA
CONJUNTOS DE FOLES E ABRAÇADEIRAS
TAPETES
LIMPADORES DE PARA-BRISAS
BICICLETA
OUTROS
SENSORES DE ESTACIONAMENTO
TUBOS FLEXÍVEIS



ACESSÓRIOS DE PNEUS

367

CONTRAPESOS
REPARAÇÃO DE FUROS
VÁLVULAS DE PNEUS
REMOÇÃO E INSTALAÇÃO

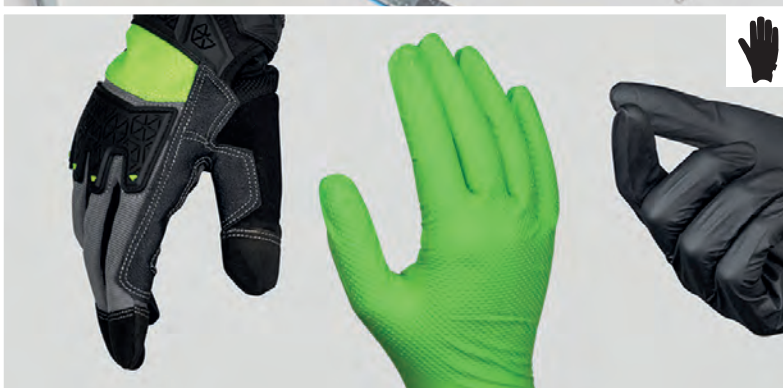

SEGURANÇA E EPI

373

LUVAS/EPI
MÁSCARAS / DISPENSADORES
DELIMITAÇÃO
MEDIDOR DE OZONO



CONSUMÍVEIS

381

CHAVETAS E ANÉIS DE RETENÇÃO
REBITES
PARAFUSOS, PORCAS, ARRUELAS
ARRUELAS PARA MOTOR E CARTER
OUTROS
JUNTAS E ANÉIS DE VEDAÇÃO
CONECTORES DE MANGUEIRAS
ELÉTRICOS
AGRAFOS E PRESILHAS DE PLÁSTICO



ROUPAS DE TRABALHO

405

COLETES
CASACOS



PROMOCIONAL

407

PRODUTOS PROMOCIONAIS
ECRÃS / ACESSÓRIOS
EMBALAGENS

JBM SUA FERRAMENTA

JBM É A SUA MARCA DE FERRAMENTAS PROFISSIONAIS

Empresa líder, especializada na indústria e no setor automotivo

+7.000

PRODUTOS
DISPONÍVEIS

+23.000

EUROPALETES
EM ESTOQUE

+68

EXPORTAMOS PARA
MAIS DE 68 PAÍSES

+550

NOVOS PRODUTOS
POR ANO

MAIS DE 30 ANOS DE EXPERIÊNCIA NO SETOR

Na JBM somos especialistas na distribuição de ferramentas e equipamentos automotivos, oferecendo um atendimento próximo e de qualidade aos nossos mais de 11.000 clientes espalhados por mais de 68 países.

ESPECIALISTAS EM DISTRIBUIÇÃO E LOGÍSTICA

A JBM dispõe de uma rede logística em constante melhoria, que permite uma distribuição rápida e eficiente não só na Península Ibérica mas também a todos os clientes internacionais.

AMPLA GAMA DE PRODUTOS

Oferecemos uma gama completa de mais de 7.000 itens como caixas de ferramentas, estojos, mobiliário para oficina, todos os tipos de ferramentas manuais, ferramentas de oficina, iluminação, estojos de consumíveis...



**SERVIÇO
DE QUALIDADE
APOIADO POR MAIS
DE 11.000 CLIENTES**

**ENTREGAS
INTERNACIONAIS
EXPORTAMOS PARA MAIS
DE 68 PAÍSES**

**SEDE EM ESPANHA E
ARMAZÉM DE MAIS DE
6.000M²**



CONJUNTOS DE FERRAMENTAS

- 9 CONJUNTOS DE FERRAMENTAS
- 17 CONJUNTOS DE CHAVES DE CAIXA
- 24 CAIXAS / MALETAS DE FERRAMENTAS
- 28 CONJUNTOS DE PONTAS
- 32 CONJUNTO DE CATRACAS MINI
- 32 CONJUNTO DE ADAPTADORES
- 33 KIT DE PONTAS
- 34 KIT DE CHAVES DE CAIXA
- 35 FERRAMENTAS COM ISOLAMENTO



FERRAMENTAS DE ALTA QUALIDADE PARA O DIA A DIA

01

PROJETADAS PARA UM ÓTIMO
DESEMPENHO EM TODOS OS TIPOS
DE TRABALHO

02

MATERIAL RESISTENTE COM
ACABAMENTO EM AÇO CROMADO
DE ÓTIMA QUALIDADE

03

CABO ERGONÔMICO DE GRANDE
DIÂMETRO PARA UMA MELHOR
CAPACIDADE DE TORÇÃO



54034

178,00€

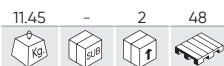

CAIXA DE FERRAMENTAS DE 216 PEÇAS COM CHAVES HEXAGONAIS ZINCADAS



ZINCADO

54045

179,00€



CAIXA DE FERRAMENTAS 216 PEÇAS COM CHAVES HEXAGONAIS - CROMADO



CROMADO



CONTÉM

	1/2" x14	13, 14, 15, 16, 17, 18, 19, 20, 21, 22, 24, 27, 30, 32mm
	3/8" x10	10, 11, 12, 13, 14, 15, 16, 17, 18, 19mm
	1/4" x13	4, 4.5, 5, 5.5, 6, 7, 8, 9, 10, 11, 12, 13, 14mm
	1/2" x5	16, 17, 18, 19, 22mm
	3/8" x6	10, 11, 12, 13, 14, 15mm
	1/4" x7	4, 5, 6, 7, 8, 9, 10mm
	1/2" x3	E20, E22, E24
	3/8" x6	E10, E11, E12, E14, E16, E18
	1/4" x5	E4, E5, E6, E7, E8
	3/8" x3	1/2" - 3/8" - 1/4"
	1/2" x2	125, 250mm
	3/8" x1	125mm
	1/4" x2	50, 100mm
	x3	1/2" - 3/8" - 1/4"
	1/2" x1	adaptador 3/8" H x 1/2" M
	1/2" x1	8mm
	3/8" x1	8mm
	1/4" x1	6mm

	1/2" x2	16, 21mm
	3/8" x1	18mm
	1/2" x12	8, 9, 10, 11, 12, 13, 14, 15, 16, 17, 18, 19mm
	1/2" x7	1.27, 1.5, 2, 2.5, 3, 4, 5mm
	1/4" x1	
	1/4" x1	
	1/4" x1	
	1/2" x1	T70
	1/2" x1	14mm
	x3	PH0, PH1, PH2
	x3	P20, P21, P22
	x4	3, 4, 5, 6mm
	x4	SL4, SL5.5, SL6.5, SL7
	x8	T8, T9, T10, T15, T20, T25, T27, T30
	x8	T8, T9, T10, T15, T20, T25, T27, T30

	8mm x4	7, 8, 10, 12mm
	6mm x6	2, 2.5, 3, 4, 5, 6mm
	8mm x3	SL8, SL10, SL12
	8mm x3	PH2, PH3, PH4
	8mm x3	P22, P23, P24
	8mm x5	T40, T45, T50, T55, T60
	6mm x3	T5, T6, T7
	8mm x5	T40, T45, T50, T55, T60
	6mm x1	T7
	8mm x4	M10, M11, M12, M13
	6mm x5	M5, M6, M7, M8, M9
	8mm x2	M10, M12
	6mm x3	M5, M6, M8
	8mm x1	TS50
	6mm x8	TS10, TS15, TS20, TS25, TS27, TS30, TS40, TS45
	x4	0, 1, 2, 3mm
	x3	6, 8, 10mm
	6mm x4	4, 6, 8, 10mm
	x3	1, 2, 3mm
	x4	1, 2, 3, 4mm
	6mm x1	1/4"

54250

188,00€

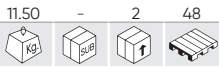

CAIXA DE FERRAMENTAS DE 216 PEÇAS 12 FACES (XZN) - ZINCADAS



ZINCADO



CONTÉM

	1/2" x14	13, 14, 15, 16, 17, 18, 19, 20, 21, 22, 24, 27, 30, 32mm
	3/8" x10	10, 11, 12, 13, 14, 15, 16, 17, 18, 19mm
	1/4" x13	4, 4.5, 5, 5.5, 6, 7, 8, 9, 10, 11, 12, 13, 14mm
	1/2" x5	16, 17, 18, 19, 22mm
	3/8" x6	10, 11, 12, 13, 14, 15mm
	1/4" x7	4, 5, 6, 7, 8, 9, 10mm
	1/2" x3	E20, E22, E24
	3/8" x6	E10, E11, E12, E14, E16, E18
	1/4" x5	E4, E5, E6, E7, E8
	1/2" x3	1/2" - 3/8" - 1/4"
	1/2" x2	125, 250mm
	3/8" x1	125mm
	1/4" x2	50, 100mm
	1/2" x3	1/2" - 3/8" - 1/4"
	1/2" x1	adaptador 3/8" H x 1/2" M

	1/2" x1	8mm
	3/8" x1	8mm
	1/4" x1	6mm
	1/2" x2	16, 21mm
	3/8" x1	18mm
	1/2" x12	8, 9, 10, 11, 12, 13, 14, 15, 16, 17, 18, 19mm
	1/2" x7	1.27, 1.5, 2, 2.5, 3, 4, 5mm
	1/4" x1	
	1/4" x1	
	1/4" x1	
	1/2" x1	T70
	1/2" x1	14mm
	x3	PH0, PH1, PH2
	x3	PZ0, PZ1, PZ2
	x4	3, 4, 5, 6mm
	1/4" x4	SL4, SL5.5, SL6.5, SL7
	x8	T8, T9, T10, T15, T20, T25, T27, T30
	x8	T8, T9, T10, T15, T20, T25, T27, T30

	8mm x4	7, 8, 10, 12mm
	6mm x6	2, 2.5, 3, 4, 5, 6mm
	8mm x3	SL8, SL10, SL12
	8mm x3	PH2, PH3, PH4
	8mm x3	PZ2, PZ3, PZ4
	8mm x5	T40, T45, T50, T55, T60
	6mm x3	T5, T6, T7
	8mm x5	T40, T45, T50, T55, T60
	6mm x1	T7
	8mm x4	M10, M11, M12, M13
	6mm x5	M5, M6, M7, M8, M9
	8mm x2	M10, M12
	6mm x3	M5, M6, M8
	8mm x1	TS50
	6mm x8	TS10, TS15, TS20, TS25, TS27, TS30, TS40, TS45
	x4	0, 1, 2, 3mm
	x3	6, 8, 10mm
	6mm x4	4, 6, 8, 10mm
	x3	1, 2, 3mm
	x4	1, 2, 3, 4mm
	6mm x1	1/4"

54082

189,00€

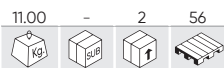

CAIXA DE FERRAMENTAS DE 132 PEÇAS COM CHAVES HEXAGONAIS ZINCADAS



ZINCADO



REPOSIÇÕES DISPONÍVEIS

ESPECIAL AUTOMAÇÃO



CONTÉM

	1/2" x7 19, 21, 22, 24, 27, 30, 32mm
	3/8" x12 8, 9, 10, 11, 12, 13, 14, 15, 16, 17, 18, 19mm
	1/4" x11 4, 5, 5.5, 6, 7, 8, 9, 10, 11, 12, 13mm
	3/8" x4 13, 14, 15, 17mm
	1/4" x4 8, 10, 12, 13mm
	3/8" x6 E8, E10, E11, E14, E16, E20
	1/2" x1
	3/8" x1
	1/4" x1
	1/2" x2 127, 254mm
	3/8" x2 76, 152mm
	1/4" x1 50mm
	x1 Ø14mm
	x1

	x1 3/8"(H) - 1/2"(M)
	x1 3/8"(H) - 1/2"(M)
	x1 3/8"(H) - 1/2"(M)
	1/2" x1
	3/8" x1
	1/4" x1
	1/2" x3 17, 19, 21mm
	1/4" x1 6mm
	x1
	x1 PH2x100
	x1 SL6x100
	x12 8, 9, 10, 11, 12, 13, 14, 15, 16, 17, 18, 19mm
	x1
	1/2" x1 H17
	x1

	1/2" x1 21mm
	3/8" x2 16, 18mm
	1/2" x1 T52
	1/2" x1 M16
	x2 5.5, 6.5mm
	x2 PH1, PH3
	3/8" x2 PZ1, PZ3
	x4 4, 5, 6, 8mm
	x6 T20, T30, T40, T45, T50, T55
	x3 4, 5, 6.5mm
	x3 PH1, PH2, PH3
	6mm x3 PZ1, PZ2, PZ3
	x4 3, 4, 5, 6
	x7 T10, T15, T20, T25, T27, T30, T40
	x9 1.5, 2, 2.5, 3, 4, 5, 6, 8, 10mm

54035

149,00€

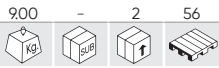

CAIXA DE FERRAMENTAS DE 179 PEÇAS COM CHAVES HEXAGONAIS ZINCADAS



ZINCADO

54046

150,00€

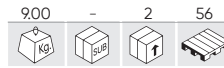

CAIXA DE FERRAMENTAS 179 PEÇAS COM CHAVES HEXAGONAIS - CROMADO



CROMADO



CONTÉM

	1/2" x17	10, 11, 12, 13, 14, 15, 16, 17, 18, 19, 20, 21, 22, 24, 27, 30, 32mm
	3/8" x10	10, 11, 12, 13, 14, 15, 16, 17, 18, 19mm
	1/4" x13	4, 4.5, 5, 5.5, 6, 7, 8, 9, 10, 11, 12, 13, 14mm
	1/2" x5	16, 17, 18, 19, 22mm
	3/8" x6	10, 11, 12, 13, 14, 15mm
	1/4" x7	4, 5, 6, 7, 8, 9, 10mm
	1/2" x2	E20, E24
	3/8" x6	E10, E11, E12, E14, E16, E18
	1/4" x5	E4, E5, E6, E7, E8
	1/2" x3	1/2" - 3/8" - 1/4"
	1/2" x2	125, 250mm
	3/8" x1	125mm
	1/4" x2	50, 100mm

	x3	1/2" - 3/8" - 1/4"
	1/2" x2	16, 21mm
	3/8" x1	18mm
	1/2" x1	8mm
	3/8" x1	8mm
	1/4" x1	6mm
	x7	1.27, 1.5, 2, 2.5, 3, 4, 5mm
	x1	1/4"
	x1	1/4"
	x3	PH1, PH2, PH3
	x3	PZ1, PZ2, PZ3
	1/4" x5	2, 3, 4, 5, 6mm
	x3	SL4, SL5.5, SL7
	x8	T8, T9, T10, T15, T20, T25, T27, T30
	x8	T8, T9, T10, T15, T20, T25, T27, T30

	x11	T5, T6, T7, T8, T9, T10, T15, T20, T25, T27, T30
	x9	T7, T10, T15, T20, T25, T27, T30, T40, T45
	x5	M5, M6, M7, M8, M9
	x3	M5, M6, M8
	x2	PH3, PH4
	x2	PZ3, PZ4
	x5	7, 8, 10, 12, 14mm
	x3	SL8, SL10, SL12
	x6	T40, T45, T50, T55, T60, T70
	x6	T40, T45, T50, T55, T60, T70

54036

99,00€

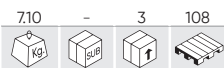

CAIXA DE FERRAMENTAS DE 113 PEÇAS COM CHAVES HEXAGONAIS ZINCADAS



ZINCADO

54047

100,00€



CAIXA DE FERRAMENTAS DE 113 PEÇAS 12 FACES (XZN) - CROMADO



CROMADO



REPOSIÇÕES DISPONÍVEIS



REPOSIÇÕES DISPONÍVEIS

CONTÉM

	1/2"	x17	10, 11, 12, 13, 14, 15, 16, 17, 18, 19, 20, 21, 22, 24, 27, 30, 32mm
	1/4"	x13	4, 4.5, 5, 5.5, 6, 7, 8, 9, 10, 11, 12, 13, 14mm
	1/2"	x5	14, 15, 17, 19, 22mm
	1/4"	x8	6, 7, 8, 9, 10, 11, 12, 13mm
	1/2"	x8	E10, E11, E12, E14, E16, E18, E20, E24
	1/4"	x5	E4, E5, E6, E7, E8
		x2	1/2" - 1/4"
	1/2"	x2	125, 250mm
	1/4"	x2	50, 100mm

		x2	1/2" - 1/4"
	1/2"	x1	adaptador 3/8" H x 1/2" M
	1/2"	x1	8mm
		x5	7, 8, 10, 12, 14mm
		x3	SL8, SL10, SL12
		x2	PH3, PH4
	8mm	x2	PZ3, PZ4
		x5	T40, T45, T50, T55, T60
		x5	5, 6, 8, 10, 12mm

	1/2"	x2	16, 21mm
		x3	1.5, 2, 2.5mm
		x1	1/4"
		x1	1/4"
		x2	PH1, PH2
		x2	PZ1, PZ2
	1/4"	x4	3, 4, 5, 6mm
		x3	SL4, SL5.5, SL6.5
		x7	T8, T10, T15, T20, T25, T27, T30

54037

88,00€

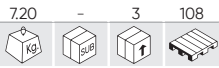

CAIXA DE FERRAMENTAS DE 108 PEÇAS COM CHAVES HEXAGONAIS ZINCADAS



ZINCADO

54048

89,00€

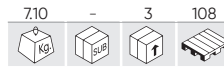

CAIXA DE FERRAMENTAS 108 PEÇAS COM CHAVES HEXAGONAIS - CROMADO



CROMADO



REPOSIÇÕES DISPONÍVEIS



REPOSIÇÕES DISPONÍVEIS

CONTÉM

	1/2"	x17	10, 11, 12, 13, 14, 15, 16, 17, 18, 19, 20, 21, 22, 24, 27, 30, 32mm
	1/4"	x13	4, 4.5, 5, 5.5, 6, 7, 8, 9, 10, 11, 12, 13, 14mm
	1/2"	x5	14, 15, 17, 19, 22mm
	1/4"	x8	6, 7, 8, 9, 10, 11, 12, 13mm
	1/2"	x8	E10, E11, E12, E14, E16, E18, E20, E24
	1/4"	x5	E4, E5, E6, E7, E8
	1/2"	x2	1/2" - 1/4"
	1/2"	x2	125, 250mm
	1/4"	x2	50, 100mm
	1/2"	x2	1/2" - 1/4"
	1/2"	x1	adaptador 3/8" H x 1/2" M

	1/2"	x2	16, 21mm
	1/2"	x1	8mm
		x3	1.5, 2, 2.5mm
		x1	1/4"
		x1	1/4"
		x2	PH3, PH4
		x2	PZ3, PZ4
	8mm	x5	7, 8, 10, 12, 14mm
		x3	SL8, SL10, SL12
		x5	T40, T45, T50, T55, T60

		x2	PH1, PH2
		x2	PZ1, PZ2
	1/4"	x4	3, 4, 5, 6mm
		x3	SL4, SL5.5, SL6.5
		x7	T8, T10, T15, T20, T25, T27, T30

54038

88,00€

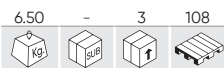

CAIXA DE FERRAMENTAS DE 94 PEÇAS COM CHAVES HEXAGONAIS ZINCADAS



ZINCADO



54049

89,00€



CAIXA DE FERRAMENTAS 94 PEÇAS COM CHAVES HEXAGONAIS - CROMADO



CROMADO



CONTÉM

	1/2"	x18	10, 11, 12, 13, 14, 15, 16, 17, 18, 19, 20, 21, 22, 23, 24, 27, 30, 32mm
	1/4"	x13	4, 4.5, 5, 5.5, 6, 7, 8, 9, 10, 11, 12, 13, 14mm
	1/2"	x4	14, 15, 17, 19mm
	1/4"	x8	6, 7, 8, 9, 10, 11, 12, 13mm
	1/2"	x2	1/2" - 1/4"
	1/2"	x2	125, 250mm
	1/4"	x2	50, 100mm
		x2	1/2" - 1/4"
	1/2"	x1	adaptador 3/8" H x 1/2" M

	1/2"	x1	8mm
		x3	1.5, 2, 2.5mm
	1/2"	x2	16, 21mm
		x2	PH3, PH4
		x2	PZ3, PZ4
	8mm	x4	8, 10, 12, 14mm
		x3	SL8, SL10, SL12
		x4	T40, T45, T50, T55
	8mm	x1	1/4"

		x1	1/4"
		x1	1/4"
		x1	1/4"
		x2	PH1, PH2
		x2	PZ1, PZ2
	1/4"	x4	3, 4, 5, 6mm
		x3	SL4, SL5.5, SL7
		x6	T8, T10, T15, T20, T25, T30

53212

174,00€

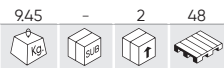

CAIXA DE FERRAMENTAS DE 303 PEÇAS COM CHAVES HEXAGONAIS ZINCADAS



ZINCADO



CONTÉM

	x18	10, 11, 12, 13, 14, 15, 16, 17, 18, 19, 20, 21, 22, 23, 24, 27, 30, 32mm
	x2	125, 250mm
	x2	16, 21mm
	x1	8mm
	x1	adaptador 3/8" H x 1/2" M
	x1	UNIVERSAL
	x1	72
	x13	4, 4.5, 5, 5.5, 6, 7, 8, 9, 10, 11, 12, 13, 14mm
	x2	50, 100mm
	x1	6,3mm
	x1	1/4"
	x1	UNIVERSAL
	x1	72
	x8	T25, T27, T30, T35, T40 (x2), T45, T50
	x2	PH3, PH4
	x2	PZ3, PZ4
	x4	H5.5, H6.5, H7, H8
	x4	5.5, 6.5, 7, 8mm
	x4	5, 6, 8, 10mm

	x9	3, 4, 4.5, 5, 5.5, 6, 6.5, 7, 8mm
	x9	T8, T10, T15, T20, T25, T27, T30, T35, T40
	x9	H1.5, H2, H2.5, H3, H.4, H5, H5.5, H6, H8
	x3	5, 6, 8mm
	x4	1, 2, 3, 4
	x3	6, 8, 10
	x3	C1, C2, C3
	x6	2, 2.5, 3, 4, 5, 6mm
	x4	S0, S1, S2, S3
	x6	5/64, 3/32, 7/64, 1/8, 9/64, 5/32
	x4	4, 6, 8, 10mm
	x10	PH0 (x2), PH1 (x2), PH2 (x4), PH3 (x2)
	x10	PZ0 (x2), PZ1 (x2), PZ2 (x4), Z3 (x2)
	x10	1/16, 5/64, 3/32, 7/64, 1/8, 9/64, 5/32, 3/16, 7/32, 1/4
	x10	T8, T10, T15, T20, T25, T27, T30, T35, T40, T45
	x6	1.5, 2, 2.5, 3, 3.5, 4mm
	x4	PH000, PH00, PH0, PH1
	x2	PZ0, PZ1
	x8	T5, T6, T7, T8, T9, T10, T15, T20

	x1		x1	300g
	x1		x1	
	x10		x1	
	x1		x23	
	x1	3m		x22
	x1			x10
	x1	8"		x10
	x2	0.4x2.5, 0.5x3.0x50mm		
	x3	PH0x50, PH00x50, PH000x50mm		
	x2	0.8x4x100, 1.2x6.5x125mm		
	x2	PH1x80, PH2x100mm		
	x7	1.27, 1.5, 2, 2.5, 3, 4, 5mm		
	x13	1.5, 2, 2.5, 3, 3.2, 3.5, 4, 4.5, 4.8, 5, 5.5, 6, 6.5mm		



54106

89,00€

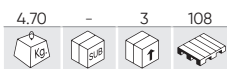

CAIXA DE FERRAMENTAS EM POLEGADAS ZINCADA COM 37 PEÇAS



ZINCADO



REPOSIÇÕES DISPONÍVEIS

CONTÉM

	1/2" x17	5/16", 3/8", 7/16", 1/2", 9/16", 19/32", 5/8", 11/16", 3/4", 13/16", 7/8", 15/16", 1", 1-1/16", 1-1/8", 1-3/16", 1-1/4"		1/2" x2	5" - 10"
	1/4" x8	3/16", 7/32", 1/4", 9/32", 5/16", 11/32", 3/8", 7/16"		1/4" x1	3"
	x2	1/2" - 1/4"		x1	1/2" - 1/4"
	x2	1/2" - 1/4"		x1	1/4"
	x2	16, 21mm			

53074

78,00€

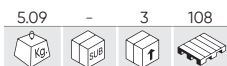

MALA DE FERRAMENTAS DE 74 PEÇAS COM CHAVES DE 12 GUMES, ZINCADA



ZINCADO



REPOSIÇÕES DISPONÍVEIS



CONTÉM

	1/2" x18	10, 11, 12, 13, 14, 15, 16, 17, 18, 19, 20, 21, 22, 23, 24, 27, 30, 32mm
	1/4" x10	4, 5, 5.5, 6, 7, 8, 10, 11, 12, 13mm
	x2	1/2" - 1/4"
	x2	125, 250mm
	1/4" x1	100mm
	x1	1/2"
	x5	PH0, PH1, PH2, PH3, PH4
	x5	PZ0, PZ1, PZ2, PZ3, PZ4
	x6	3, 4, 5, 6, 8, 10mm
	x5	SL3, SL4, SL5.5, SL6, SL7
	x8	T8, T10, T15, T20, T25, T27, T30, T40
	x4	4, 5, 6, 7mm
	1/2" x1	adaptador 3/8" H x 1/2" M
	1/2" x1	21mm
	x3	1.5, 2, 2.5mm
	x1	1/4"
	1/4" x1	6mm

54140

36,00€



KIT DE FERRAMENTAS DE 56 PEÇAS COM SOQUETES DE 12 GUMES ZINCADOS

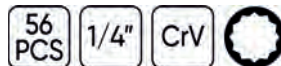

ZINCADO



REPOSIÇÕES DISPONÍVEIS



CONTÉM

	x13	4, 4.5, 5, 5.5, 6, 7, 8, 9, 10, 11, 12, 13, 14mm
	x1	T2
	x2	50, 100mm
	x1	1/4"
	x1	
	x1	
	x1	
	x1	
	x4	SL4, SL5, SL6, SL7
	x3	M5, M6, M8
	x8	T8, T10, T15, T20, T25, T27, T30, T40
	x8	T8, T10, T15, T20, T25, T27, T30, T40
	x3	PH0, PH1, PH2
	x3	PZ0, PZ1, PZ2
	x6	3, 4, 5, 6, 7, 8mm



CONJUNTOS DE FERRAMENTAS

54108

66,00€

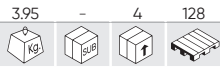

CAIXA DE FERRAMENTAS 22 PÇS. DE CHAVES HEXAGONAIS DE 1/2" ZINCADAS



ZINCADO



REPOSIÇÕES DISPONÍVEIS



CONTÉM

	1/2"	x17	10, 11, 12, 13, 14, 15, 16, 17, 18, 19, 20, 21, 22, 24, 27, 30, 32mm
	1/2"	x1	
	1/2"	x2	75, 125mm
		x1	3/8" (H) - 1/2" (M)
		x1	1/2"

54116

66,00€

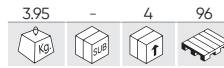

CAIXA DE FERRAMENTAS 22 PÇS. DE SOQUETES DE 12 ARESTAS 1/2" ZINCADO

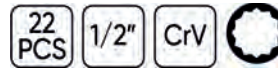

ZINCADO



REPOSIÇÕES DISPONÍVEIS



CONTÉM

	1/2"	x17	10, 11, 12, 13, 14, 15, 16, 17, 18, 19, 21, 22, 24, 27, 30, 32mm
	1/2"	x1	1/2"
	1/2"	x2	125, 250mm
	1/2"	x1	
	1/2"	x1	3/8" (H) - 1/2" (M)

51818

109,00€

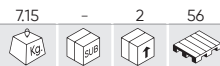

MALA DE FERRAMENTAS DE 72 PEÇAS COM CHAVES HEXAGONAIS ZINCADAS



ZINCADO



REPOSIÇÕES DISPONÍVEIS

CONTÉM

	1/2"	x13	10, 11, 12, 13, 14, 15, 17, 19, 22, 24, 27, 30, 32mm
	1/4"	x10	4, 5, 6, 7, 8, 9, 10, 11, 12, 13mm
	1/4"	x5	5, 6, 7, 8, 9mm
	1/2"	x1	1/2"
	1/4"	x1	1/4"
	1/2"	x1	125mm
	1/4"	x1	75mm

		x1	
		x1	300gr
		x1	
		x1	
		x4	SL3, SL4, SL5, SL6
	6mm	x3	PH1, PH2, PH3
		x7	T10, T15, T20, T25, T27, T30, T40

		x2	1/2" - 1/4"
	1/2"	x2	16, 21mm
	1/4"	x1	6mm
		x8	10, 11, 12, 13, 14, 15, 17, 19mm
		x3	1.5, 2, 2.5mm
		x1	1/4"
		x2	PH2x100, PH1x40mm
		x3	8x200, 6x100, 6x40mm

54258

58,00€

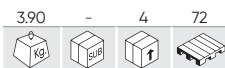

CONJUNTO DE FERRAMENTAS ZINCADO DE 77 PEÇAS



ZINCADO



CONTÉM

	x5	PH0, PH1, PH2, PH2, PH3		x1
	x5	PZ0, PZ1, PZ2, PZ2, PZ3		x10
	x5	SL3, SL4, SL5, SL5.5, SL6mm		x1
	x5	T10, T15, T20, T25, T30		x1
	x4	6x7, 8x9, 10x11, 12x13mm		x1
	x9	1.5, 2, 2.5, 3, 4, 5, 6, 8, 10mm		x1
	x3	PH2x100, PH00x50, PH000x50		x1
	x3	SL6x100, SL2.5x50, SL3.0x50		x10
	x1			x10



54277

53,50€

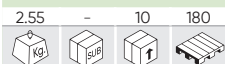

CAIXA DE FERRAMENTAS 3/8" DE 59 PEÇAS COM CHAVES HEXAGONAIS ZINCADAS

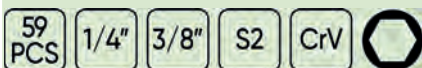

ZINCADO



CONTÉM

	3/8"	x17	6, 7, 8, 9, 10, 11, 12, 13, 14, 15, 16, 17, 18, 19, 20, 21, 22mm		x2	PH3, PH4
	3/8"	x1	3/8"		x2	PZ3, PZ4
	3/8"	x2	75, 150mm		x5	8mm
	3/8"	x1	8mm		x3	7, 8, 10, 12, 14mm
	3/8"	x1	3/8"		x3	SL8, SL10, SL12
	1/4"	x1	1/4"		x5	T40, T45, T50, T55, T60
	3/8"	x17	6, 7, 8, 9, 10, 11, 12, 13, 14, 15, 16, 17, 18, 19, 20, 21, 22mm		x2	PH1, PH2
	3/8"	x1	3/8"		x2	PZ1, PZ2
	3/8"	x2	75, 150mm		x4	1/4"
	3/8"	x1	8mm		x3	3, 4, 5, 6mm
	3/8"	x1	3/8"		x3	SL4, SL5.5, SL6.5
	1/4"	x1	1/4"		x7	T8, T10, T15, T20, T25, T27, T30

53953

29,00€

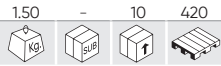

JOGO DE SOQUETES E BITS 130 PCS. ZINCADO

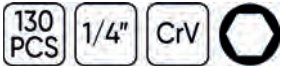

ZINCADO



EM EXPOSITOR DE 10 UDS



REPOSIÇÕES DISPONÍVEIS

CONTÉM

		1/4"	x13	4, 4.5, 5, 5.5, 6, 7, 8, 9, 10, 11, 12, 13, 14mm
		1/4"	x1	1/4"
		1/4"	x1	50mm
		1/4"	x1	1/4"
		1/4"	x1	6mm
		1/4"	x1	1/4"
		1/4"	x1	1/4"
		1/4"	x7	1.27, 1.5, 2, 2.5, 3, 4, 5mm

	25mm	x10	T8, T10, T15, T20, T25, T27, T30, T35, T40, T45
	25mm	x9	T8, T10, T15, T20, T25, T27, T30, T35, T40
	25mm	x3	M5, M6, M8
	25mm	x3	6, 8, 10mm
	25mm	x3	C1, C2, C3
	25mm	x4	1, 2, 3, 4mm
	25mm	x4	4, 6, 8, 10mm
	25mm	x4	0, 1, 2, 3mm

	25mm	x10	1/16, 5/64, 3/32, 7/64, 1/8, 9/64, 5/32, 3/16, 7/32, 1/4
	25mm	x9	1.5, 2, 2.5, 3, 4, 5, 5.5, 6, 8mm
	25mm	x6	5/64, 3/32, 7/64, 1/8, 9/64, 5/32
	25mm	x6	2, 2.5, 3, 4, 5, 6mm
	25mm	x9	3, 4, 4.5, 5, 5.5, 6, 6.5, 7, 8mm
	50mm	x2	4, 6mm
	25mm	x10	PH0(x2), PH1(x2), PH2(x4), PH3(x2)
	50mm	x2	PH1, PH2
	25mm	x10	P20(x2), PZ1(x2), PZ2(x4), PZ3(x2)

54109

34,00€

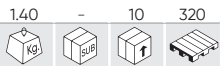

CONJUNTO DE 46 PEÇAS COM ENCAIXES HEXAGONAIS ZINCADOS



ZINCADO



REPOSIÇÕES DISPONÍVEIS



CONTÉM

		1/4"	x13	4, 4.5, 5, 5.5, 6, 7, 8, 9, 10, 11, 12, 13, 14mm
		1/4"	x1	
		1/4"	x1	
		1/4"	x1	
		1/4"	x2	50, 100mm
			x4	1.27, 1.5, 2.0, 2.5mm
			x1	
			x1	UNIVERSAL
			x1	1/4"
			x3	SL4, SL5.5, SL7
			x3	PH1, PH2, PH3
			x3	PZ1, PZ2, PZ3
			x6	H3, H4, H5, H6, H7, H8
			x6	T10, T15, T20, T25, T30, T40

54168

49,00€

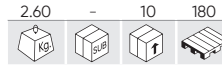

KIT DE FERRAMENTAS DE 59 PEÇAS DE 3/8" COM CHAVES DE 12 PONTAS ZINCADAS



ZINCADO



REPOSIÇÕES DISPONÍVEIS



CONTÉM

			x2	PH3, PH4
			x2	PZ3, PZ4
		8mm	x5	7, 8, 10, 12, 14mm
			x3	8, 10, 12mm
			x5	T40, T45, T50, T55, T60
			x2	PH1, PH2
			x2	PZ1, PZ2
		1/4"	x4	3, 4, 5, 6mm
			x3	4, 5.5, 6.5mm
			x7	T8, T10, T15, T20, T25, T27, T30
		3/8"	x17	6, 7, 8, 9, 10, 11, 12, 13, 14, 15, 16, 17, 18, 19, 20, 21, 22mm
			x1	3/8"
		3/8"	x2	75, 150mm
		3/8"	x1	8mm
		3/8"	x1	8mm
		3/8"	x1	
		1/4"	x1	

54105 33,00€

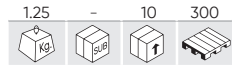

KIT DE FERRAMENTAS DE 59 PEÇAS DE 3/8" COM CHAVES DE 12 PONTAS ZINCADAS



ZINCADO



CONTÉM

	1/4"	x13	4, 4.5, 5, 5.5, 6, 7, 8, 9, 10, 11, 12, 13, 14mm
	1/4"	x1	
	1/4"	x2	50, 100mm
	1/4"	x1	
	1/4"	x1	
	1/4"	x1	
	1/4"	x1	
	1/4"	x1	6mm
	PH0, PH1, PH2	x3	
	PZ0, PZ1, PZ2	x3	
	3, 4, 5, 6, 7, 8mm	x6	
	6mm	x4	SL4, SL5, SL6, SL7
	6mm	x3	M5, M6, M8
	6mm	x8	T8, T10, T15, T20, T25, T27, T30, T40
	6mm	x8	T8, T10, T15, T20, T25, T27, T30, T40
	6mm	x1	1/4"

52418 179,00€

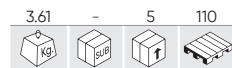

CAIXA DE FERRAMENTAS DE PASSAGEM COM 39 PEÇAS CROMADA



CROMADO

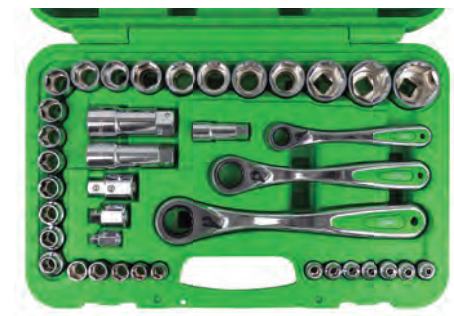

CONTÉM

	13mm	x12	4, 4.5, 5, 5.5, 6, 7, 8, 9, 10, 11, 12, 13mm
	19mm	x10	10, 11, 12, 13, 14, 15, 16, 17, 18, 19mm
	22mm	x5	20, 21, 22, 23, 24mm
	22mm	x3	27, 30, 32mm
	1/2"	x3	13, 19, 22mm
	1/2"	x3	13, 19, 22mm
	1/4"	x1	13mm
	3/8"	x1	19mm
	1/2"	x1	22mm

54090 56,00€

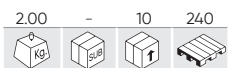

KIT DE FERRAMENTAS DE PASSAGEM DE 14 PEÇAS ZINCADO

ZINCADO



CONTÉM

	x11	13, 14, 15, 16, 17, 18, 19, 21, 22, 24, 27mm
	x1 (75mmL)	12,5mm
	x1	1/2"
	x1 (go-through)	

50623 60,00€



CAIXA CROMADA DE 17 PEÇAS, EMBORA COM GO-THROUGH

CROMADO



CONTÉM

	x13	4, 4.5, 5, 5.5, 6, 7, 8, 9, 10, 11, 12, 13, 14mm
	x1	75mm
	x1	1/4"
	x1	145mm

52722

87,00€



CAIXA DE FERRAMENTAS COM 61 PEÇAS SOQUETES ESTRIADOS DE 1/2" E 1/4" ZINCADOS

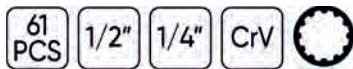

ZINCADO



REPOSIÇÕES DISPONÍVEIS

CONTÉM

	1/2"	x11	14, 15, 16, 17, 18, 19, 22, 24, 27, 30, 32mm
	1/4"	x12	4, 4.5, 5, 5.5, 6, 7, 8, 9, 10, 11, 12, 13mm
		x2	1/2" - 1/4"
	1/2"	x2	5" - 10"
	1/4"	x2	2" - 4"
		x2	1/2" - 1/4"

		x1	adaptador 3/8" H x 1/2" M
	1/2"	x2	16, 21mm
		x1	25mm
		x3	1.5, 2, 2.5mm
		x1	1/4"
		x1	1/4"
		x1	AD

		x3	PH1, PH2, PH3
		x3	PZ1, PZ2, PZ3
	25mm	x5	3, 4, 5, 6, 8mm
		x3	SL4, SL5.5, SL7
		x5	T10, T15, T20, T25, T30

53915

65,00€

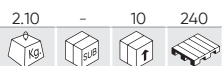

CONJUNTO DE 6 CHAVES DE CAIXA 1/2" TORX TIPO E EXTRA LONGAS ZINCADAS

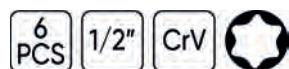

ZINCADO



CONTÉM

		1/2"	x6	E10, E12, E14, E16, E18, E20
--	--	------	----	------------------------------

E12 Soquete para cabeça do bloco de cilindros BMW:
 - Motor M42, 1,8 L, 4 cilindros, 16 V, modelo 318 (1989)
 - Motor M50, 2.0L, 2.5L, 6 cilindros, 24V, modelos 520i, 525i (1991)

53108

92,00€



CAIXA DE FERRAMENTAS 61 PEÇAS CHAVES ESTRIADAS DE 1/2" E 1/4" CROMADAS



CROMADO



REPOSIÇÕES DISPONÍVEIS

CONTÉM

		x3	PH1, PH2, PH3
		x3	PZ1, PZ2, PZ3
	25mm	x5	3, 4, 5, 6, 8mm
		x3	SL4, SL5.5, SL7
		x5	T10, T15, T20, T25, T30

54141

42,00€



JOGO 28 CHAVES TORX CURTAS E LONGAS ZINCADAS

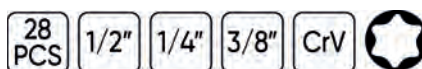

ZINCADO



CONTÉM

		1/4"	x5 (25mm)	E4, E5, E6, E7, E8
		3/8"	x5 (28mm)	E10, E11, E12, E14, E16
		1/2"	x4 (38mm)	E18, E20, E22, E24
		1/4"	x5 (50mm)	E4, E5, E6, E7, E8
		3/8"	x5 (63mm)	E10, E11, E12, E14, E16
		1/2"	x4 (76mm)	E18, E20, E22, E24



REPOSIÇÕES DISPONÍVEIS



51616 378,00€

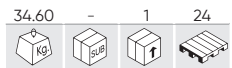

CAIXA METÁLICA COM 22 PEÇAS DE AUTOCLAVE HEXAGONAL ZINCADO DE 1"

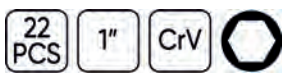

ZINCADO



CAIXA METÁLICA
CONTÉM

	1"	x17	36, 38, 41, 46, 50, 54, 55, 58, 60, 63, 65, 67, 70, 71, 75, 77, 80mm
	1"	x1	650mm
	1"	x2	205, 410mm
	1"	x1	
	1"	x1	



51855 378,00€



CAIXA METÁLICA COM 22 PEÇAS DE AUTOCLAVE DE 1" EM 12 ARESTAS ZINCADAS

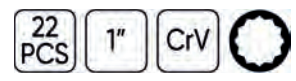

ZINCADO



CAIXA METÁLICA
CONTÉM

	1"	x17	36, 38, 41, 46, 50, 54, 55, 58, 60, 63, 65, 67, 70, 71, 75, 77, 80mm
	1"	x1	650mm
	1"	x2	205, 410mm
	1"	x1	
	1"	x1	



53727 198,00€

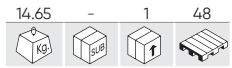

CAIXA DE FERRAMENTAS COM 21 PEÇAS SOQUETE HEXAGONAL DE 3/4" ZINCADO

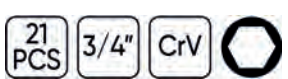

ZINCADO



CONTÉM

	3/4"	x16	19, 21, 22, 23, 24, 26, 27, 29, 30, 32, 35, 36, 38, 41, 46, 50mm
	3/4"	x1	495mm
	3/4"	x3	100, 200, 400mm
	3/4"	x1	445mm



53728 198,00€

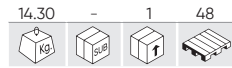

CAIXA DE FERRAMENTAS COM 21 PEÇAS DE 12 GUMES DE 3/4" ZINCADOS

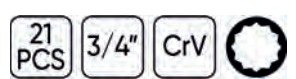

ZINCADO



CONTÉM

	3/4"	x16	19, 21, 22, 23, 24, 26, 27, 29, 30, 32, 35, 36, 38, 41, 46, 50mm
	3/4"	x1	495mm
	3/4"	x3	100, 200, 400mm
	3/4"	x1	445mm



54261

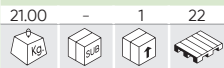

321,00€



N

CAIXA METÁLICA COM FERRAMENTAS 143 PEÇAS ZINCADA



ZINCADO



REPOSIÇÕES DISPONÍVEIS

CONTÉM

	x13	4, 4.5, 5, 5.5, 6, 7, 8, 9, 10, 11, 12, 13, 14mm		x20	8, 9, 10, 11, 12, 13, 14, 15, 16, 17, 18, 19, 20, 21, 22, 23, 24, 27, 30, 32mm		x4	SL5x75, SL6x100, SL8x150, SL10x200mmL		
	x6	8, 10, 11, 12, 13, 14mm		x2	5" - 10"		x3	PH1x80, PH2x100, PH3x150mmL		
	x7	E4, E5, E6, E7, E8, E10, E11		x2	1/2"	x2	16, 21mm		x4	PH1, PH2x2, PH3
	x2	2", 4"		x1	UNIVERSAL		x4	PZ1, PZ2x2, PZ3		
	x1	110mmL		x1	3/8"(F) - 1/2"(M)		x4	SL3, SL4, SL5, SL6		
	1/4"	x1		x1	150L		x4	H3, H4, H5, H6		
	x3	PH1, PH2, PH3		x3	SL4, SL5.5, SL6.5		x7	T10, T15, T20, T25, T27, T30, T40		
	x6	TT10, TT15, TT20, TT25, TT30, TT40		x6	H3, H4, H5, H6, H7, H8		x7	TT10, TT15, TT20, TT25, TT27, TT30, TT40		
	x6	H3, H4, H5, H6, H7, H8		x3	SL4, SL5.5, SL6.5		x1	1/4"		
	x1	250mm		x6	TT10, TT15, TT20, TT25, TT30, TT40		x1	6.35mmx60mmL		
	x1	250mm		x6	H3, H4, H5, H6, H7, H8		x1	1/4"-6.35mm		
	x1	250mm		x6	H3, H4, H5, H6, H7, H8		x1	7"-180mm		
	x1	250mm		x6	H3, H4, H5, H6, H7, H8		x1	7"-180mm		
	x1	250mm		x6	H3, H4, H5, H6, H7, H8		x1	10"-250mm		
	x1	250mm		x6	H3, H4, H5, H6, H7, H8		x1	10"-250mm		

53565

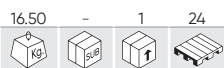

258,00€



CAIXA DE FERRAMENTAS EM FERRO 64 PEÇAS ZINCADA



ZINCADO

CONTÉM

	1/2"	x18	10, 11, 12, 13, 14, 15, 16, 17, 18, 19, 20, 21, 22, 23, 24, 27, 30, 32mm		
	x1	1/2"			
	x1	1/2"			
	1/2"	x3	76, 127, 254mm		
	1/2"	x1	255mm		
	1/2"	x1	21mm		
	x1	457mm			
	x18	6, 7, 8, 9, 10, 11, 12, 13, 14, 15, 16, 17, 18, 19, 20, 21, 22, 24mm			
	x9	1.5, 2, 2.5, 3, 4, 5, 6, 8, 10mm			
	x3	PH1x100, PH2x150, H3x200mm			
	x3	SL5x100, SL6x150, SL8x200mm			
	x1	250mm		x1	180mm
	x1	200mm		x1	180mm



REPOSIÇÕES DISPONÍVEIS



53159

289,00€

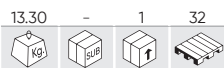

CAIXA DE FERRAMENTAS EM ALUMÍNIO 159 PEÇAS ZINCADA



ZINCADO



REPOSIÇÕES DISPONÍVEIS

CONTÉM



	1/2" x14	14, 15, 16, 17, 18, 19, 20, 21, 22, 23, 24, 27, 30, 32mm
	1/4" x10	4, 5, 6, 7, 8, 9, 10, 11, 12, 13mm
	x2	1/4" - 1/2"
	1/2" x2	50, 100mm
	1/4" x2	125, 250mm
	1/4" x1	150mm
	x2	1/4" - 1/2"
	1/2" x1	adaptador 3/8" H x 1/2" M
	x2	1/4" - 1/2"
	1/4" x1	250mm
	1/4" x1	110mm
	1/2" x2	16, 21mm
	x1	1/4"

	x9	8, 10, 11, 12, 13, 15, 17, 19, 22mm
	x9	1.5, 2, 2.5, 3, 4, 5, 6, 8, 10mm
	x1	100-250V
	x1	
	x2	PH1x80, PH2x10mm
	x4	SL3x75, SL4x100, SL6.5x125, SL8x150mm
	x1	PH00x50mm
	x1	SL2.5x50mm
	x1	250mm
	x1	200mm
	x1	160mm
	x1	7" (180mm)
	x1	180mm
	x1	220mm
	x1	160mm
	x1	160mm

	x1	
	x6	1,5mm
	x1	
	x1	300gr
	x1	3m
	x1	200mm
	x5	
	x1	18mm
	x10	
	x40	6.35mm
	x15	8mm



53928

278,00€

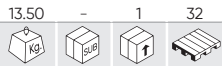

CAIXA DE FERRAMENTAS DE 135 PEÇAS COM CHAVES HEXAGONAIS ZINCADAS



ZINCADO



CONTÉM



	x10	10, 11, 12, 13, 14, 15, 17, 19, 22, 24mm
	x2	16, 21mm
	x1	UNIVERSAL
	x2	125, 250mm
	x1	3/8" - 1/2"
	x1	
	x9	4, 5, 6, 7, 8, 9, 10, 11, 12mm
	x1	UNIVERSAL
	x1	
	x2	50, 100mm
	x1	6mm
	x9	8, 10, 11, 12, 13, 14, 17, 19, 22mm
	x1	150mm
	x1	

	x4	PH1, PH2, PH2, PH3
	x4	PZ1, PZ2, PZ2, PZ3
	x4	SL3, SL4, SL5, SL6
	x4	H3, H4, H5, H6
	x7	TT10, TT15, TT20, TT25, TT27, T30, T40
	x7	TT10, TT15, TT20, TT25, TT27, TT30, TT40
	x1	6mm
	x1	6mmL
	x5	
	x1	
	x2	PH1x80mm, PH2x100mm, SL3.0x75mm, SL4.0x100mm, SL6.5x125mm, SL8x150mm
	x4	

	x1	
	x1	
	x3	SL1.5, SL2, SL3, PH000, PH00, PH0, PH1, T4, T5, T6, T7, T8, T10, T15, T20
	x4	
	x8	T8, T10, T15, T20
	x4	TS0.8, TS1.2, TS1.5, TS2.0
	x1	H2.0
	x1	
	x1	
	x1	
	x9	1.5, 2, 2.5, 3, 4, 5, 6, 8, 10mm
	x1	
	x1	5m
	x1	300g

	x1	250mm
	x1	180mm
	x1	180mm
	x1	200mm
	x1	160mm
	x1	200mm
	x1	
	x3	
	x1	18mm

53444

195,00€

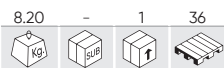

CAIXA DE FERRAMENTAS EM ALUMÍNIO 108 PÇS. SOQUETES 1/2" ZINCADOS

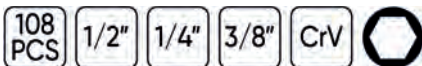

ZINCADO



CONTÉM



	x9	10, 11, 12, 13, 14, 15, 17, 18, 19mm
	x2	75, 150mm
	x1	1/2" 16mm
	x1	Ⓢ
	x1	adaptador 3/8" H x 1/2" M
	x8	4, 4.5, 5, 5.5, 6, 7, 8, 9mm
	x1	1/4" 150mmL
	x1	6mm
	x2	PH1x80, PH2x100mm
	x4	SL3.5x75, SL4x100, SL6.5x125, SL8x150mm
	x1	PH00x50mm
	x1	SL2.5x50mm
	x1	

	x9	6x7, 8x9, 10x11, 12x13, 14x15, 16x17, 18x19, 20x22mm
	x9	1.5, 2, 2.5, 3, 4, 5, 6, 8, 10mm
	x1	
	x6	
	x1	200mm
	x1	18mm
	x10	
	x1	220mm
	x1	180mm
	x1	160mm
	x1	250mm
	x1	160mm

	x30	
	x1	
	x1	300g
	x1	3m



52603

74,00€

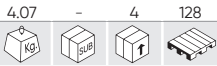

CAIXA DE PONTAS 12 FACES 26 PEÇAS



REPOSIÇÕES DISPONÍVEIS

CONTÉM

	x8 (55mmL)	M5, M6, M8, M9, M10, M12, M14, M16
	x7 (100mmL)	M5, M6, M8, M9, M10, M12, M14
	x7 (140mmL)	M5, M6, M8, M9, M10, M12, M14
	x4 (200mmL)	M8, M10, M12, M14

52606

88,00€



CAIXA DE PONTAS RIBE 32 PEÇAS

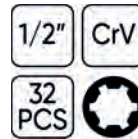

REPOSIÇÕES DISPONÍVEIS

CONTÉM

	x9 (55mmL)	M5, M6, M7, M8, M9, M10, M12, M13, M14
	x9 (100mmL)	M5, M6, M7, M8, M9, M10, M12, M13, M14
	x7 (140mmL)	M7, M8, M9, M10, M12, M13, M14
	x7 (200mmL)	M7, M8, M9, M10, M12, M13, M14

52604

78,00€

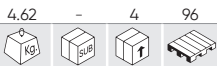

CAIXA DE PONTAS HEXAGONAIS 30 PEÇAS

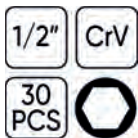

REPOSIÇÕES DISPONÍVEIS

CONTÉM

	x9 (55mmL)	5, 6, 7, 8, 10, 12, 14, 17, 19mm
	x8 (100mmL)	5, 6, 7, 8, 10, 11, 12, 13mm
	x7 (140mmL)	5, 6, 7, 8, 10, 12, 14mm
	x6 (200mmL)	5, 6, 7, 8, 10, 12mm

52605

76,00€



CAIXA DE PONTAS TORX 32 PEÇAS

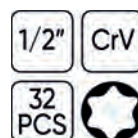

REPOSIÇÕES DISPONÍVEIS

CONTÉM

	x10 (55mmL)	T20, T25, T27, T30, T40, T45, T50, T55, T60, T70
	x10 (100mmL)	T20, T25, T27, T30, T40, T45, T50, T55, T60, T70
	x6 (140mmL)	T40, T45, T50, T55, T60, T70
	x6 (200mmL)	T40, T45, T50, T55, T60, T70

54266

39,50€

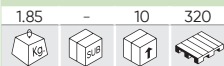

N

CONJUNTO DE CHAVES DE CAIXA TORX E BROCAS 1/2" 19 PEÇAS



CONTÉM

	x9	E10, E11, E12, E14, E16, E18, E20
	x10	T20, T25, T27, T30, T40, T45, T50, T55, T60, T70



REPOSIÇÕES DISPONÍVEIS

54154

37,50€



CAIXA DE 12 PEÇAS 1/2" PONTA DE TORX

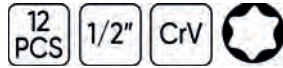

CONTÉM

	x6	T20, T25, T30, T40, T45, T50
	x6	T55, 60, T70, T80, T90, T100



REPOSIÇÕES DISPONÍVEIS

51260

37,00€

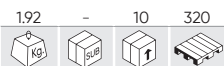

CAIXA DE 12 PEÇAS 1/2" HEXAGONAL

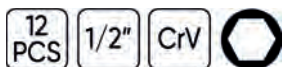

CONTÉM

	x6	H5, H6, H7, H8, H10, H12
	x1	H14
	x5	H16, H17, H18, H19, H20



REPOSIÇÕES DISPONÍVEIS

54164

34,00€



CAIXA DE 12 PEÇAS 1/2" 12 FACES

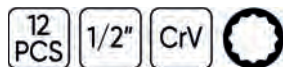

CONTÉM

	x6 (55mmL)	M4, M5, M6, M8, M9
	x6 (70mmL)	M10, M12, M14, M16, M18, M20



REPOSIÇÕES DISPONÍVEIS

50983

48,00€

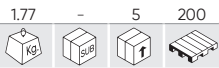

CAIXA DE 42 PEÇAS HEX, 12 CANTOS E TORX

42 PCS 1/2"
3/8" S-2



CONTÉM

	3/8"	x1	10mm
	1/2"	x1	10mm
	30mm	x7	4, 5, 6, 7, 8, 10, 12mm
	75mm	x7	4, 5, 6, 7, 8, 10, 12mm
	30mm	x8	T20, T25, T30, T40, T45, T50, T55, T60
	75mm	x8	T20, T25, T30, T40, T45, T50, T55, T60
	30mm	x5	M5, M6, M8, M10, M12
	75mm	x5	M5, M6, M8, M10, M12



50985

59,00€

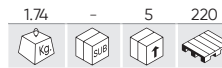

CAIXA DE 42 PEÇAS DE 12 E 6 CANTOS - INVIOLÁVE

42 PCS 1/2"
3/8" S-2



CONTÉM

	3/8"	x1	10mm
	1/2"	x1	10mm
	30mm	x7	4, 5, 6, 7, 8, 10, 12mm
	75mm	x7	4, 5, 6, 7, 8, 10, 12mm
	30mm	x8	T20, T25, T30, T40, T45, T50, T55, T60
	75mm	x8	T20, T25, T30, T40, T45, T50, T55, T60
	30mm	x5	M5, M6, M8, M10, M12
	75mm	x5	M5, M6, M8, M10, M12



52550

92,00€

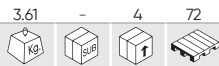

CAIXA DE PONTAS 75 PEÇAS HEXAGONAIS, XZN, RIBE, TORX E TORX ÍNV.

75 PCS 1/2"
3/8" S-2

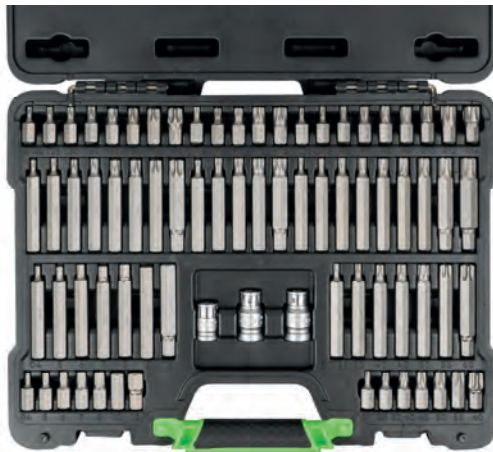

CONTÉM

	3/8"	x1	10mm
	1/2"	x2	10mm
	30mm	x7	4, 5, 6, 7, 8, 10, 12mm
	75mm	x7	4, 5, 6, 7, 8, 10, 12mm
	30mm	x8	T20, T25, T30, T40, T45, T50, T55, T60
	75mm	x8	T20, T25, T30, T40, T45, T50, T55, T60
	30mm	x5	M5, M6, M8, M10, M12
	75mm	x5	M5, M6, M8, M10, M12
	30mm	x8	R5, R6, R7, R8, R9, R10, R12, R14
	75mm	x8	R5, R6, R7, R8, R9, R10, R12, R14
	30mm	x8	TT20, TT25, TT30, TT40, TT45, TT50, TT55, TT60
	75mm	x8	TT20, TT25, TT30, TT40, TT45, TT50, TT55, TT60

52753

107,00€

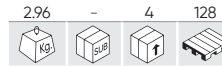

CAIXA DE FERRAMENTAS DE 55 PONTAS - HEAVY DUTY

55 PCS 1/2"
3/8" S-2



CONTÉM

	3/8"	x1	10mm
	1/2"	x2	10, 14mm
	30mm	x9	4, 5, 6, 7, 8, 10, 12, 14, 16mm - ISO 2136
	75mm	x9	4, 5, 6, 7, 8, 10, 12, 14, 16mm - ISO 2136
	30mm	x10	T20, T25, T30, T40, T45, T50, T55, T60, T70, T80 - DIN 2325
	75mm	x10	T20, T25, T30, T40, T45, T50, T55, T60, T70, T80 - DIN 2325
	30mm	x7	M5, M6, M8, M10, M12, M14, M16 - DIN 2325
	75mm	x7	M5, M6, M8, M10, M12, M14, M16 - DIN 2325

52539

59,00€

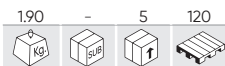

CAIXA DE PONTAS VARIADAS



CONTÉM

	x10	PH3, PH4
	x10	PZ3, PZ4
	x25	7, 8, 10, 12, 14mm
	x15	SL8, SL10, SL12
	x25	T40, T45, T50, T55, T60



52538

62,00€



CAIXA DE PONTAS VARIADAS



CONTÉM

	x10	PH1, PH2
	x10	PZ1, PZ2
	x20	3, 4, 5, 6mm
	x15	SL4, SL5.5, SL6.5
	x35	T8, T10, T15, T20, T25, T27, T30



53574

47,00€



CAIXA DE 208 BITS



CONTÉM

	x12	1.5, 2, 2.5, 3, 3.5, 4, 4.5, 5, 5.5, 6, 7, 8mm
	x10	1/16, 5/64, 3/32, 7/64, 1/8, 9/64, 5/32, 3/16, 7/32, 1/4
	x5	2.5, 3, 4, 5, 6mm
	x5	2.5, 3, 4, 5, 6mm
	x18	PH00, PH0, PH1(x5), PH2(x5), PH3(x5), PH4
	x3	PH1, PH2, PH3
	x3	PH1, PH2, PH3
	x17	PZ00, PZ0, PZ1(x5), PZ2(x5), PZ3(x4), PZ4
	x3	PZ1, PZ2, PZ3
	x3	PZ1, PZ2, PZ3
	x14	T5, T6, T7, T8, T9, T10, T15, T20, T25, T27, T30, T35, T40, T45
	x7	T10, T15, T20, T25, T27, T30, T40
	x7	T10, T15, T20, T25, T27, T30, T40

	x3	6, 8, 10mm
	x3	6, 8, 10mm
	x4	4, 6, 8, 10mm
	x4	4, 6, 8, 10mm
	x4	1, 2, 3, 4mm
	x4	1, 2, 3, 4mm
	x6	2, 2.5, 3, 4, 5, 6mm
	x6	5/64, 3/32, 7/64, 1/8, 9/64, 5/32
	x13	T5, 6, 7, 8, 9, 10, 15, 20, 25, 27, 30, 40, 45
	x3	1, 2, 3mm
	x4	0, 1, 2, 3mm
	x3	M5, M6, M8
	x9	TS10, TS15, TS20, TS25, TS27, TS30, TS40, TS45, TS50

	x12	SL2, SL2.5, SL3, SL3.5, SL4, SL4.5, SL5, SL5.5, SL6, SL6.5, SL7, SL8
	x10	4, 5, 6, 7, 8, 9, 10, 11, 12, 13
	x10	5/32, 3/16, 7/32, 1/4, 9/32, 5/16, 11/32, 3/8, 7/16, 1/2
	x1	1/4"
	x1	
	x1	



52620

8,80€



PORTAPUNTAS ANGULAR

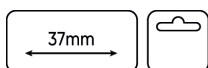

- Para áreas de difícil acesso.
- Com a função de plugue rápido.
- Extrair facilmente.
- Broca de 6mm.

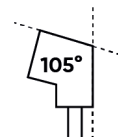

53156

26,20€

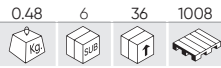

CAIXA DE FERRAMENTAS DE 38 PEÇAS COM MINI ROQUETE DE 1/4"



REPOSIÇÕES DISPONÍVEIS



CONTÉM

	1/4"	x11	4, 4.5, 5, 6, 7, 8, 9, 10, 11, 12, 13mm		6mm	x5	4, 5, 6, 7, 8mm
	1/4"	x1			6mm	x3	SL6, SL8, SL10
		x2	PH3, PH4		6mm	x8	T8, T9, T10, T15, T20, T25, T30, T40
		x2	PZ3, PZ4		6mm	x4	M5, M6, M9, M10
		x1	1/4"			x1	1/4"

52198

37,70€

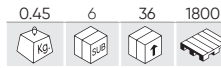

CAIXA DE FERRAMENTAS DE 37 PEÇAS COM MINI ROQUETE DE 1/4"

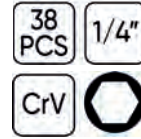

REPOSIÇÕES DISPONÍVEIS



CONTÉM

	1/4"	x11	4, 4.5, 5, 6, 7, 8, 9, 10, 11, 12, 13mm		6mm	x5	4, 5, 6, 7, 8mm
	1/4"	x1			6mm	x3	SL6, SL8, SL10
		x2	PH3, PH4		6mm	x8	T8, T9, T10, T15, T20, T25, T30, T40
		x2	PZ3, PZ4		6mm	x4	M5, M6, M9, M10
		x1	1/4"			x1	1/4"

51333

18,00€

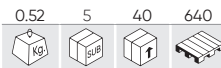

JOGO DE 6 ADAPTADORES



REPOSIÇÕES DISPONÍVEIS

REF.	mm				€
11360	1/4H - 3/8M	0.03	10	100	2,60€
11361	1/4M - 3/8H	0.03	5	300	3,20€
11362	1/2H - 3/4M	0.14	10	100	5,20€
11363	3/8H - 1/2M	0.50	10	100	3,90€
11364	1/2H - 3/8M	0.05	10	100	4,50€
11365	3/4H - 1/2M	0.14	10	100	9,40€

53743

39,70€

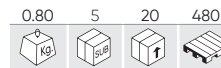

KIT DE 6 ADAPTADORES DE IMPACTO



REPOSIÇÕES DISPONÍVEIS

REF.	mm				€
14749	1/4"H - 3/8"M	0.03	20	200	2,00€
14750	3/8"H - 1/4"M	0.05	20	100	2,00€
14751	3/8"H - 1/2"M	0.15	20	100	4,00€
14752	1/2"H - 3/8"M	0.16	10	100	4,00€
11962	1/2"H - 3/4"M	0.17	10	100	7,50€
11964	3/4"H - 1/2"M	0.35	10	100	12,50€



52714 15,70€

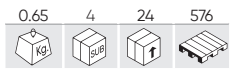

JOGO DE PONTAS DE 1/2" HEXAGONAIS

10 PCS 1/2" CrV

10, 11, 12, 13, 14, 15, 16, 17, 18, 19mm



52716 15,90€

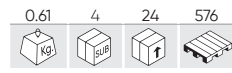

JOGO DE PONTAS 1/2" 12 FACES

10 PCS 1/2" CrV

10, 11, 12, 13, 14, 15, 16, 17, 18, 19mm



52715 10,00€

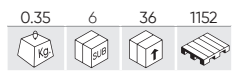

JOGO DE PONTAS DE 1/4" HEXAGONAIS

13 PCS 1/4" CrV

4, 4.5, 5, 5.5, 6, 7, 8, 9, 10, 11, 12, 13, 14mm



52717 11,00€

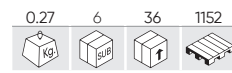

JOGO DE PONTAS DE 1/4" 12 FACES

13 PCS 1/4" CrV

4, 4.5, 5, 5.5, 6, 7, 8, 9, 10, 11, 12, 13, 14mm



51410 36,00€

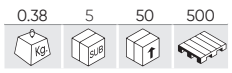

KIT DE 6 PEÇAS 1/2" PONTA TORX INTERIOR

6 PCS 1/2" CrV

T55, T60, T70, T80, T90, T100



51409 36,00€

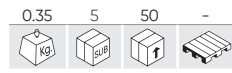

KIT DE 6 PEÇAS 1/2" 12 FACES INTERIOR / PONTA XZN

6 PCS 1/2" CrV

M10, M12, M14, M16, M18, M20



52909

12,50€

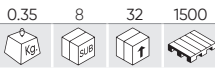

KIT DE 18 PONTAS DE 1/4"



REPOSIÇÕES DISPONÍVEIS

CONTÉM

	x2	PH1, PH2		x3	SL4, SL5.5, SL6.5
	x2	PZ1, PZ2		x7	T8, T10, T15, T20, T25, T27, T30
	x4	3, 4, 5, 6mm			

52908

17,00€

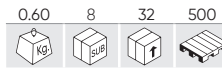

KIT DE 30 PONTAS DE 1/4"

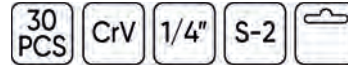

REPOSIÇÕES DISPONÍVEIS

CONTÉM

	x3	PH0, PH1, PH2		x4	SL4, SL5.5, SL6.5, SL7
	x3	PZ0, PZ1, PZ2		x8	T8, T9, T10, T15, T20, T25, T27, T30
	x4	3, 4, 5, 6mm		x8	T8, T9, T10, T15, T20, T25, T27, T30

53084

24,00€

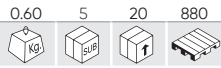

KIT DE PONTAS TORX 3/8" - 1/2"

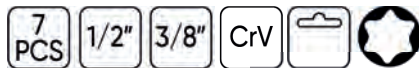

REPOSIÇÕES DISPONÍVEIS

	x2	T55, T60, T70		x5	T30, T40, T45, T50
--	----	---------------	--	----	--------------------

53127

12,00€

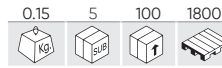

KIT DE 7 PONTAS TORX INVIOLÁVEL 1/4"



REPOSIÇÕES DISPONÍVEIS

	x7	T10, T15, T20, T25, T30, T40, T45
--	----	-----------------------------------

51746

12,00€

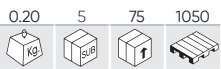

KIT DE PONTAS TS 5 CARAS INVIOLÁVEL



	x7	TS10, TS15, TS20, TS25, TS30, TS40, TS45
--	----	--

50980

22,00€

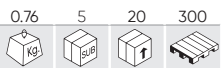

KIT DE PONTAS DE RIBE



	x7	100mm	M12, M13, M14
	x7	90mm	M6, M7, M8, M10

50982

22,00€

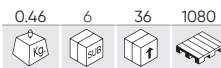

KIT DE PONTAS DE UMBRAKO EM BOLA



	x7	100mm	
	x7	4, 5, 6, 7, 8, 10mm	

52320

22,00€

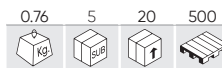

KIT DE PONTAS 12 FACES



	x7	100mm	M12, M13, M14
	x7	90mm	M6, M7, M8, M10

12029

5,50€

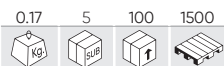

CHAVE PONTA 1/2" XZN INVIOLÁVEL M16X58MM ESP.VAG



12030

6,50€



CHAVE PONTA 1/2" XZN INVIOLÁVEL M16X100MM ESP.VAG



VARILHA EXTRA-LARGA DE 12 FACES DE 800mm de 1/2"

REF.	DESCRIÇÃO					€
52059	Ø 8mm - 800mm	0.57	-	25	1750	29,00€
52060	Ø 10mm - 800mm	0.57	-	25	1750	32,00€
53667	Ø 12mm - 800mm	0.80	10	20	-	32,00€
53668	Ø 14mm - 800mm	1.05	10	20	-	34,00€



54091

441,00€



MALETA DE FERREMENTA ISOLADA - 26PEÇAS



54093

441,00€



MÓDULO EVA DE FERRAMENTA ISOLADA

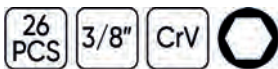
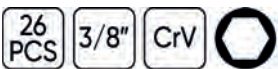

CONTÉM

	3/8" x10	8, 10, 11, 12, 13, 14, 16, 17, 18, 19, 21, 22mm
	3/8" x1	200mm
	1/2" x1	125mm
	3/8" x1	200mm

	x2	4x100mmL, 5,5x125mmL
	x2	PH1x80mm, PH2x100mm
	x1	185mm
	x1	

	x6	7x86, 8x99, 10x109, 12x127, 14x141, 17x156mm
	x1	185mm

15162

30,20€



MÓDULO DE FERRAMENTAS VDE EM FIBRA DE CARBONO, BANDEJA DE EVA - 8 PEÇAS



REPOSIÇÕES DISPONÍVEI

REF.	Ø	kg	Box	Box	€
15227	0.5x3.0x75mm	0,02	10	50	3,50€
15228	0.8x4.0x100mm	0,05	10	50	4,00€
15229	1.0x5.5x125mm	0,08	5	50	5,00€
15230	1.2x6.5x150mm	0,11	5	50	5,00€
15231	PH0x75mm	0,02	10	50	3,50€
15232	PH1x80mm	0,05	10	50	4,00€
15233	PH2x100mm	0,08	5	50	5,00€
15234	Tester Circuito Automotivo 140mm	0,02	10	50	3,00€

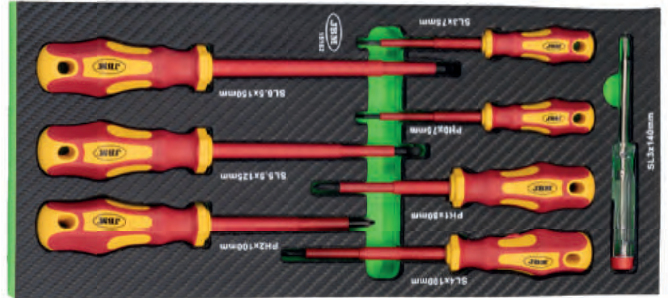

- ⊖ x4 0.5x3.0x75, 0.8x4.0x100, 1.0x5.5x125, 1.2x6.5x150mm
- ⊕ x3 PH0x75, PH1x80, PH2x100mm
- 🔍 x1 SL3x140mm

53154

462,00€

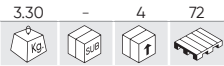

MALETA DE FERRAMENTA ISOLADA 20 PEÇAS DE 3/8"



CONTÉM

🔧	3/8"	x12	8, 10, 11, 12, 13, 14, 16, 17, 18, 19, 21, 22mm
🔧	3/8"	x1	200mm
🔧	3/8"	x2	125, 250mm
🔧	3/8"	x1	200mm
🔧	3/8"	x4	75mm, 4, 5, 6, 8mm



52519

25,50€

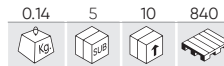

KIT DE 7 CHAVES ISOLADAS ATÉ 1.000V



CONTÉM

- ⊕ x2 PH00x50, PH0x50mm
- ⊖ x5 SL1.5x0.23x50, SL1.8x0.30x50, SL2.0x0.40x50, SL2.5x0.40x50, SL3.0x0.50x50mm

NAVALHA CORTA CABOS

REF.	DESCRIÇÃO	kg	Box	Box	€
53164	RETA	0.10	6	36	16,50€
53165	CURVADA	0.10	6	36	19,60€



FERRAMENTAS MANUAIS

- 38 CHAVES
- 48 SARGENTOS
- 49 CATRACAS
- 51 CHAVES DINAMOMETRICAS
- 53 BARRAS DE EXTENSÃO
- 53 CHAVES DE FENDAS
- 56 ALICATES
- 62 FERRAMENTAS DE INSPEÇÃO
- 63 MARTELOS
- 64 FERRAMENTAS DE CORTE
- 65 CINZÉIS
- 66 REBITADORES
- 68 FERRAMENTAS DE MEDIÇÃO
- 69 DIVERSOS

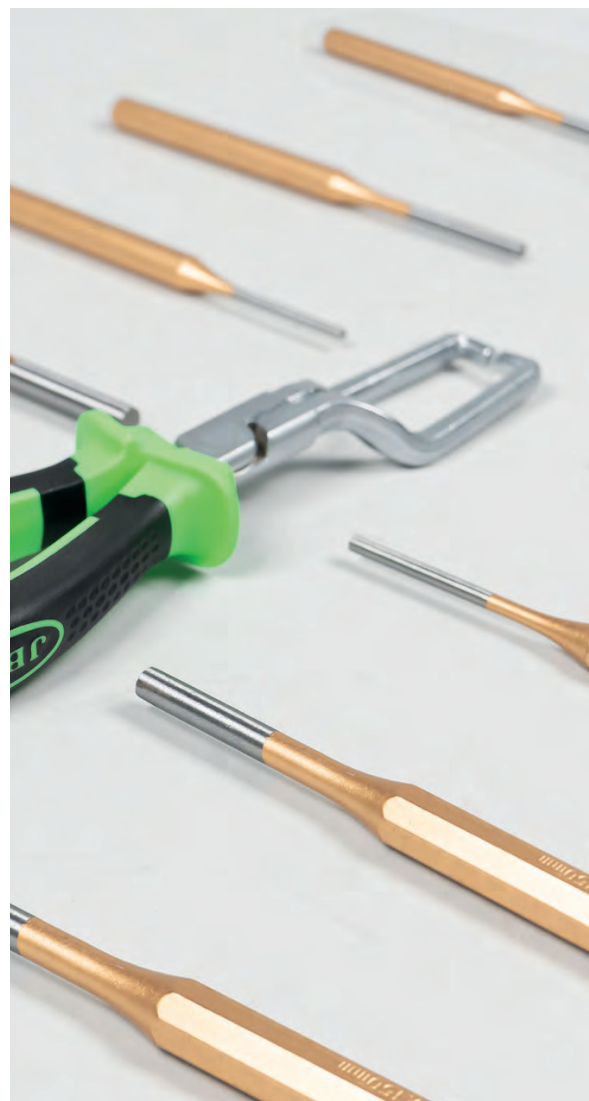

54101

61,00€

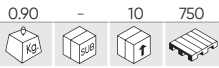

CONJUNTO DE 6 CHAVES COMBINADAS COM ROQUETE



8x9, 10x11, 12x13, 14x15, 16x18, 17x19mm



REPOSIÇÕES DISPONÍVEI

REF.	mm	Kg	Box	Box	€
15632	8x9	0.04	10	100	9,00€
15633	10x11	0.07	10	100	9,50€
15634	12x13	0.11	10	100	11,00€

REF.	mm	Kg	Box	Box	€
15635	14x15	0.13	10	100	12,50€
15636	16x18	0.19	10	100	14,00€
15637	17x19	0.25	10	100	15,00€

53017

57,00€

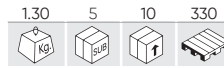

CONJUNTO DE 7 CHAVES ARTICULADAS DE BOCA-LUNETA COM ROQUETE



8, 10, 11, 13, 14, 17, 19 mm



REPOSIÇÕES DISPONÍVEI

REF.	mm	Kg	Box	Box	€
10552	8	0.06	10	100	7,10€
10554	10	0.09	10	100	7,50€
10555	11	0.09	10	100	7,80€
10557	13	0.13	10	100	8,10€

REF.	mm	Kg	Box	Box	€
10558	14	0.14	5	100	9,35€
10561	17	0.22	10	100	11,00€
10563	19	0.28	10	100	12,50€

54117

74,00€

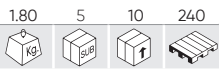

CONJUNTO DE CHAVES COMBINADAS COM ROQUETE



8, 9, 10, 11, 12, 13, 14, 15, 16, 17, 18, 19 mm



REPOSIÇÕES DISPONÍVEI

REF.	mm	Kg	Box	Box	€
13465	8	0.05	10	100	5,55€
13466	9	0.06	10	100	5,55€
13467	10	0.10	10	100	6,00€
13468	11	0.08	10	100	6,25€
13469	12	0.09	10	100	6,25€
13470	13	0.10	10	100	6,60€

REF.	mm	Kg	Box	Box	€
13471	14	0.11	10	100	6,90€
13472	15	0.13	10	100	7,25€
13473	16	0.15	10	100	8,10€
13474	17	0.19	10	100	8,70€
13475	18	0.22	10	100	9,10€
13476	19	0.22	10	100	9,60€

51318

98,00€

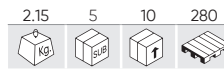

CONJUNTO DE 12 CHAVES ARTICULADAS DE BOCA-LUNETA COM ROQUETE



8, 9, 10, 11, 12, 13, 14, 15, 16, 17, 18, 19 mm



REPOSIÇÕES DISPONÍVEI

REF.	mm	Kg	Box	Box	€
10552	8	0.06	10	100	7,10€
10553	9	0.07	10	100	7,35€
10554	10	0.09	10	100	7,50€
10555	11	0.09	10	100	7,80€
10556	12	0.11	10	100	8,10€
10557	13	0.13	10	100	8,10€

REF.	mm	Kg	Box	Box	€
10558	14	0.14	5	100	9,35€
10559	15	0.16	10	100	9,50€
10560	16	0.19	5	50	10,60€
10561	17	0.22	10	100	11,00€
10562	18	0.26	5	100	12,30€
10563	19	0.28	10	100	12,50€

54338

60,00€

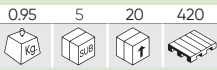

CHAVE DE ROQUETE COM CABEÇA INTERMUTÁVEL 12 PEÇAS

REPOSIÇÕES DISPONÍVEI

REF.	mm				€	REF.	mm				€
16391	8	0.01	30	100	4,60€	16397	14	0.05	30	100	5,50€
16392	9	0.05	30	100	4,60€	16398	15	0.05	30	100	5,50€
16393	10	0.05	30	100	4,60€	16399	16	0.05	30	100	5,50€
16394	11	0.05	30	100	5,10€	16401	17	0.05	30	100	6,10€
16395	12	0.05	30	100	5,10€	16402	18	0.05	30	100	6,10€
16396	13	0.05	30	100	5,10€	16403	19	0.10	30	100	6,10€



N

15316

58,00€

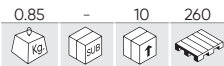

CONJUNTO DE 3 CHAVES COM 72 DENTES - TIPO 4 EM 1



REPOSIÇÕES DISPONÍVEI

REF.	mm				€
15515	12-13mm x 8-10mm	0.15	10	50	15,50€
15516	14-15mm x 9-11mm	0.20	10	50	19,00€
15517	18-19mm x 16-17mm	0.40	5	50	22,50€

54066

83,00€

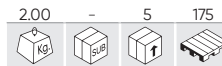

MÓDULO DE 7 CHAVES COM ROQUETE EXTRA LONGO

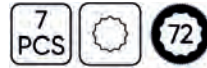

REPOSIÇÕES DISPONÍVEI

REF.	mm				€	REF.	mm				€
13453	8	0.10	6	36	9,00€	13457	14	0.25	6	36	12,00€
13454	10	0.15	10	100	9,50€	13460	17	0.40	6	24	15,00€
13455	12	0.20	6	36	10,50€	13462	19	0.50	6	24	17,00€
13456	13	0.20	6	36	11,50€						

54032

84,00€

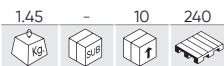

MÓDULO DE 12 MINI CHAVES COMBINADAS ARTICULADAS COM ROQUETE



REPOSIÇÕES DISPONÍVEI

REF.	mm				€	REF.	mm				€
15328	8	0.05	12	96	6,00€	15334	14	0.11	12	96	7,00€
15329	9	0.05	12	96	5,50€	15335	15	0.13	12	96	7,50€
15330	10	0.05	12	96	5,50€	15336	16	0.14	12	96	8,00€
15331	11	0.07	12	96	5,50€	15337	17	0.16	12	96	8,50€
15332	12	0.09	12	96	6,00€	15338	18	0.18	12	96	9,00€
15333	13	0.10	12	96	6,50€	15339	19	0.20	12	96	9,50€

15122

74,00€

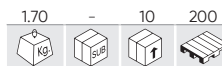

MÓDULO DE CARBONO EVA DE 12 CHAVES COMBINADAS COM ROQUETE



REPOSIÇÕES DISPONÍVEI

REF.	mm				€	REF.	mm				€
13465	8	0.05	10	100	5,55€	13471	14	0.11	10	100	6,90€
13466	9	0.06	10	100	5,55€	13472	15	0.13	10	100	7,25€
13467	10	0.10	10	100	6,00€	13473	16	0.15	10	100	8,10€
13468	11	0.08	10	100	6,25€	13474	17	0.19	10	100	8,70€
13469	12	0.09	10	100	6,25€	13475	18	0.22	10	100	9,10€
13470	13	0.10	10	100	6,60€	13476	19	0.22	10	100	9,60€

53018

119,00€



CONJUNTO DE 6 CHAVES ARTICULADAS COM ROQUETE

6 PCS **72**

8x9, 10x11, 12x13, 14x15, 16x18, 17x19mm

ARTICULADA
ARTICULATED



REPOSIÇÕES DISPONÍVEI

REF.	mm	kg	L	cm	€
13447	8x9	0.10	6	36	16,50€
13448	10x11	0.15	6	36	17,50€
13449	12x13	0.25	6	36	20,00€

REF.	mm	kg	L	cm	€
13450	14x15	0.30	6	36	23,00€
13451	16x18	0.35	6	24	28,00€
13452	17x19	0.40	6	24	29,50€

54110

46,00€

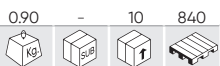

CONJUNTO DE 8 MINI CHAVES COMBINADAS COM ROQUETE

8 PCS **72**

10, 11, 12, 13, 14, 15, 17, 19mm



REPOSIÇÕES DISPONÍVEI

REF.	mm	kg	L	cm	€
13491	10	0.05	10	100	5,30€
13492	11	0.06	10	100	5,35€
13493	12	0.07	10	100	5,50€
13494	13	0.08	5	100	6,00€

REF.	mm	kg	L	cm	€
13495	14	0.09	10	100	6,40€
13496	15	0.12	10	100	6,60€
13497	17	0.14	10	100	7,50€
13498	19	0.19	10	100	8,50€

54041

198,00€

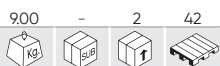

CONJUNTO DE 22 CHAVES COMBINADAS COM ROQUETE

22 PCS **90**

6, 7, 8, 9, 10, 11, 12, 13, 14, 15, 16, 17, 18, 19, 20, 21, 22, 23, 24, 27, 30, 32mm



REPOSIÇÕES DISPONÍVEI

REF.	mm	kg	L	cm	€
13463	6	0.03	10	100	5,30€
13464	7	0.04	10	100	5,30€
13465	8	0.05	10	100	5,55€
13466	9	0.06	10	100	5,55€
13467	10	0.10	10	100	6,00€
13468	11	0.08	10	100	6,25€
13469	12	0.09	10	100	6,25€
13470	13	0.10	10	100	6,60€
13471	14	0.11	10	100	6,90€
13472	15	0.13	10	100	7,25€
13473	16	0.15	10	100	8,10€

REF.	mm	kg	L	cm	€
13474	17	0.19	10	100	8,70€
13475	18	0.22	10	100	9,10€
13476	19	0.22	10	100	9,60€
13477	20	0.23	6	60	9,85€
13478	21	0.37	6	60	12,20€
13479	22	0.37	6	60	13,10€
13480	23	0.37	6	48	15,50€
13481	24	0.53	6	48	15,80€
13482	27	0.60	6	24	22,10€
13483	30	0.80	6	24	25,50€
13484	32	1.12	6	24	27,20€

54079

83,00€

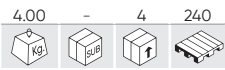

CONJUNTO DE 21 CHAVES COMBINADAS

21 PCS 6, 7, 8, 9, 10, 11, 12, 13, 14, 15, 16, 17, 18, 19, 20, 21, 22, 24, 27, 30, 32mm

REPOSIÇÕES DISPONÍVEI

REF.	mm	kg	SUB	PCS	€	REF.	mm	kg	SUB	PCS	€
10531	10	0.05	10	100	3,00€	10540	19	0.20	10	100	5,25€
10532	11	0.06	10	100	2,70€	10541	20	0.21	6	60	5,55€
10533	12	0.07	10	100	3,00€	10542	21	0.25	-	50	5,85€
10534	13	0.08	10	100	3,25€	10543	22	0.25	-	50	7,00€
10535	14	0.10	10	100	3,50€	10544	24	0.33	10	100	8,10€
10536	15	0.10	10	100	3,65€	10545	27	0.41	10	50	9,75€
10537	16	0.11	10	100	3,90€	10546	30	0.52	-	25	11,60€
10538	17	0.14	10	100	4,30€	10547	32	0.59	-	25	13,50€
10539	18	0.16	10	100	4,75€	10548	6	0.03	10	100	1,75€



REF.	mm	kg	SUB	PCS	€
10549	7	0.03	10	100	2,00€
10550	8	0.03	10	100	2,15€
10551	9	0.04	10	100	2,15€

54097

38,90€

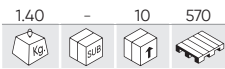

CONJUNTO DE 14 CHAVES BOCA-LUNETAS

14 PCS CrV 6, 7, 8, 9, 10, 11, 12, 13, 14, 15, 16, 17, 18, 19 mm

REPOSIÇÕES DISPONÍVEI

REF.	mm	kg	SUB	PCS	€	REF.	mm	kg	SUB	PCS	€
10531	10	0.05	10	100	3,00€	10538	17	0.14	10	100	4,30€
10532	11	0.06	10	100	2,70€	10539	18	0.16	10	100	4,75€
10533	12	0.07	10	100	3,00€	10540	19	0.20	10	100	5,25€
10534	13	0.08	10	100	3,25€	10548	6	0.03	10	100	1,75€
10535	14	0.10	10	100	3,50€	10549	7	0.03	10	100	2,00€
10536	15	0.10	10	100	3,65€	10550	8	0.03	10	100	2,15€
10537	16	0.11	10	100	3,90€	10551	9	0.04	10	100	2,15€



54120

59,00€



CONJUNTO DE 7 CHAVES COMBINADAS

7 PCS CrV 20, 21, 22, 24, 27, 30, 32mm



REPOSIÇÕES DISPONÍVEI

REF.	mm	kg	SUB	PCS	€	REF.	mm	kg	SUB	PCS	€
10541	20	0.21	6	60	5,55€	10545	27	0.41	10	50	9,75€
10542	21	0.25	-	50	5,85€	10546	30	0.52	-	25	11,60€
10543	22	0.25	-	50	7,00€	10547	32	0.59	-	25	13,50€
10544	24	0.33	10	100	8,10€						

54174

139,00€

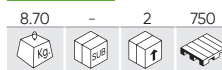

CONJUNTO DE 6 CHAVES COMBINADAS

6 PCS CrV XL 34, 36, 38, 41, 46, 50mm



REPOSIÇÕES DISPONÍVEI

REF.	mm	kg	SUB	PCS	€	REF.	mm	kg	SUB	PCS	€
16020	34	0.36	10	100	17,00€	16023	41	0.47	10	100	26,50€
16021	36	0.00	10	100	19,50€	16024	46	0.51	10	100	34,50€
16022	38	0.43	10	100	23,00€	16025	50	0.58	10	100	37,50€

50564

30,00€

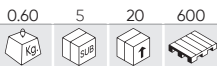

CONJUNTO DE 8 CHAVES COMBINADAS CURTAS



REPOSIÇÕES DISPONÍVEI

REF.	mm	Kg	SUB	mm	€	REF.	mm	Kg	SUB	mm	€	REF.	mm	Kg	SUB	mm	€
10564	10	0.05	10	100	2,50€	10567	13	0.05	10	100	3,50€	10570	17	0.10	10	100	4,50€
10565	11	0.05	10	100	3,50€	10568	14	0.05	10	100	4,00€	10571	19	0.15	10	100	5,00€
10566	12	0.05	10	100	3,50€	10569	15	0.05	10	100	4,50€						



54150

23,50€

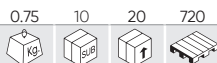

CONJUNTO DE 7 CHAVES FIXAS

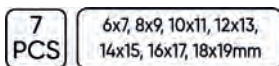

REPOSIÇÕES DISPONÍVEI

REF.	mm	Kg	SUB	mm	€	REF.	mm	Kg	SUB	mm	€
10579	10x11	0.06	10	100	3,00€	10583	18x19	0.19	10	100	4,15€
10580	12x13	0.07	10	100	3,10€	10589	6x7	0.03	10	100	2,00€
10581	14x15	0.10	10	100	3,40€	10590	8x9	0.04	10	100	2,40€
10582	16x17	0.14	10	100	4,00€						



54149

60,00€



CONJUNTO DE 12 CHAVES FIXAS

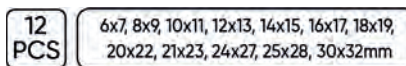

REPOSIÇÕES DISPONÍVEI

REF.	mm	Kg	SUB	mm	€	REF.	mm	Kg	SUB	mm	€
10579	10x11	0.06	10	100	3,00€	10585	21x23	0.31	-	50	6,75€
10580	12x13	0.07	10	100	3,10€	10586	24x27	0.35	10	100	7,60€
10581	14x15	0.10	10	100	3,40€	10587	25x28	0.36	-	50	9,80€
10582	16x17	0.14	10	100	4,00€	10588	30x32	0.54	-	25	10,50€
10583	18x19	0.19	10	100	4,15€	10589	6x7	0.03	10	100	2,00€
10584	20x22	0.25	6	60	5,05€	10590	8x9	0.04	10	100	2,40€



52973

59,00€



CONJUNTO DE 12 CHAVES FIXAS - ACABAMENTO BRILHANTE

REPOSIÇÕES DISPONÍVEI

REF.	mm	Kg	SUB	mm	€	REF.	mm	Kg	SUB	mm	€
10579	10x11	0.06	10	100	3,00€	10585	21x23	0.31	-	50	6,75€
10580	12x13	0.07	10	100	3,10€	10586	24x27	0.35	10	100	7,60€
10581	14x15	0.10	10	100	3,40€	10587	25x28	0.36	-	50	9,80€
10582	16x17	0.14	10	100	4,00€	10588	30x32	0.54	-	25	10,50€
10583	18x19	0.19	10	100	4,15€	10589	6x7	0.03	10	100	2,00€
10584	20x22	0.25	6	60	5,05€	10590	8x9	0.04	10	100	2,40€



6x7, 8x9, 10x11, 12x13, 14x15, 16x17, 18x19, 20x22, 21x23, 24x27, 25x28, 30x32mm



54115 26,80€

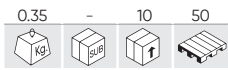

CONJUNTO DE 4 CHAVES TORX FIXAS

4 PCS E6xE8, E10xE12, E14xE18, E20xE24



REPOSIÇÕES DISPONÍVEI

REF.	mm				€
16546	E6xE8	0.05	10	100	5,00€
16547	E10xE12	0.07	10	100	5,50€
16548	E14xE18	0.08	10	100	9,00€
16549	E20xE24	0.09	10	100	14,00€

54081 28,00€

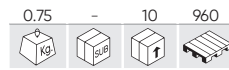

CONJUNTO DE CHAVES FIXAS COM BOCA ABERTA DE 6 FACES

5 PCS 10x11HEX, 12x13HEX, 14x15HEX, 16x17HEX, 18x19HEX



REPOSIÇÕES DISPONÍVEI

REF.	mm				€
11258	10x11	0.10	5	100	7,30€
11259	12x13	0.10	5	100	8,30€
11260	14x15	0.11	5	100	9,75€
11261	16x17	0.18	5	100	11,35€
11262	18x19	0.21	-	100	13,50€

54159 47,00€

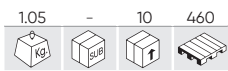

CONJUNTO DE 8 CHAVES TIPO "C" CABEÇAL REDONDO 12 CANTOS

8 PCS

6x7, 8x9, 10x11, 12x13, 14x15, 16x17, 18x19, 20x22mm



REPOSIÇÕES DISPONÍVEI

REF.	mm				€
11639	6x7	0.61	5	50	4,00€
11640	8x9	0.04	5	50	4,50€
11641	10x11	0.04	5	50	5,00€
11642	12x13	0.06	5	50	5,00€
11643	14x15	0.09	5	-	6,00€
11644	16x17	0.12	5	50	7,00€
11645	18x19	0.15	5	50	7,00€
11646	20x22	0.22	5	-	9,45€

52451 42,00€

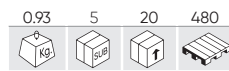

CONJUNTO DE 8 CHAVES TIPO "C" CABEÇAL REDONDO 12 CANTOS

8 PCS

6x7, 8x9, 10x11, 12x13, 14x15, 16x17, 18x19, 20x22mm



REPOSIÇÕES DISPONÍVEI

REF.	mm				€
11639	6x7	0.61	5	50	4,00€
11640	8x9	0.04	5	50	4,50€
11641	10x11	0.04	5	50	5,00€
11642	12x13	0.06	5	50	5,00€
11643	14x15	0.09	5	-	6,00€
11644	16x17	0.12	5	50	7,00€
11645	18x19	0.15	5	50	7,00€
11646	20x22	0.22	5	-	9,45€

15156 70,00€

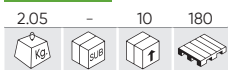

4 PÇS. CHAVE DUPLA FACE DE EXTREMIDADE FECHADA REVESTIDA DE CARBONO, BANDEJA DE EVA

REPOSIÇÕES DISPONÍVEI

REF.	mm				€
15206	21x23	0.45	5	50	15,00€
15207	24x27	0.50	5	50	16,50€
15208	25x28	0.45	5	50	17,00€
15209	30x32	0.67	10	50	18,00€

4 PCS 21x23, 24x27, 25x28, 30x32mm



FERRAMENTAS MANUAIS

54119

78,00€

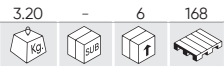

CONJUNTO DE 12 CHAVES FIXAS CURVADAS

12 PCS



6x7, 8x9, 10x11, 12x13, 14x15, 16x17, 18x19, 20x22, 21x23, 24x27, 25x28, 30x32mm



REPOSIÇÕES DISPONÍVEI

REF.	mm				€
10627	6x7	0.04	10	100	2,80€
10628	8x9	0.06	10	100	3,10€
10629	10x11	0.08	10	100	3,65€
10630	12x13	0.11	10	100	3,90€
10631	14x15	0.14	10	100	4,20€
10632	16x17	0.18	10	100	5,30€
REF.	mm				€
10633	18x19	0.22	10	100	6,60€
10634	20x22	0.43	-	50	7,80€
10635	21x23	0.30	-	50	8,15€
10636	24x27	0.35	-	25	8,80€
10637	25x28	0.48	6	24	12,10€
10638	30x32	0.73	6	24	12,70€

50562

23,50€

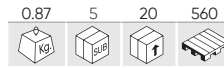

CONJUNTO DE 7 CHAVES FIXAS COM DUAS ABERTURAS

7 PCS



6x7, 8x9, 10x11, 12x13, 14x15, 16x17, 18x19mm



REPOSIÇÕES DISPONÍVEI

REF.	mm				€
10627	6x7	0.04	10	100	2,80€
10628	8x9	0.06	10	100	3,10€
10629	10x11	0.08	10	100	3,65€
10630	12x13	0.11	10	100	3,90€
REF.	mm				€
10631	14x15	0.14	10	100	4,20€
10632	16x17	0.18	10	100	5,30€
10633	18x19	0.22	10	100	6,60€

51528

49,00€

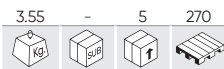

CONJUNTO DE 14 CHAVES DE DUAS BOCA EM FORMA DE "L"

14 PCS



8, 9, 10, 11, 12, 13, 14, 15, 16, 17, 18, 19, 20, 21mm



REPOSIÇÕES DISPONÍVEI

REF.	mm				€
10591	10	0.09	10	200	2,50€
10592	11	0.12	10	200	2,55€
10593	12	0.16	10	120	3,15€
10594	13	0.17	10	100	3,20€
10595	14	0.20	10	100	3,35€
10596	15	0.25	10	70	4,25€
10597	16	0.30	10	70	4,50€
REF.	mm				€
10598	17	0.32	10	60	4,60€
10599	18	0.43	10	40	6,00€
10600	19	0.41	10	40	6,25€
10601	20	0.45	10	30	6,50€
10602	21	0.47	10	30	7,05€
10603	8	0.07	10	300	2,10€
10604	9	0.08	10	200	2,25€

53420

72,00€

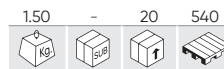

CONJUNTO DE 8 CHAVES DE TUBO

8 PCS



6x7, 8x9, 10x11, 12x13, 14x15, 16x17, 18x19, 20x22mm



53979

34,60€

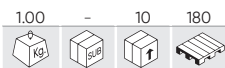

CONJUNTO DE 8 CHAVES TORX EN "T"



T10x75, T15x75, T20x100, T25x100, T30x150, T40x150, T45x200, T50x200mm

53980

34,60€

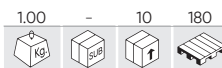

CONJUNTO DE 8 CHAVES EN "T" CABEÇA REDONDA

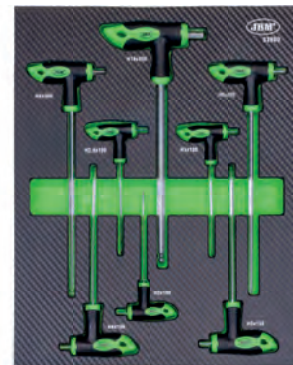

H2x100, H2.5x100, H3x100, H4x150, H5x150, H6x200, H8x200, H10x200

JOGOS 6 CHAVES EXTRA-LARGAS

51864

64,00€

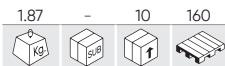

10x11mm (290mmL), 12x14mm (330mmL), 13x15mm (368mmL), 16x18mm (407mmL), 17x19mm (407mmL), 22x24mm (430mmL)



52912

91,00€

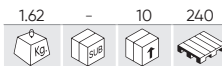

E6xE7 (200mmL), E8xE10 (235mmL), E11xE12 (290mmL), E14xE16 (370mmL), E18xE20 (410mmL), E22xE24 (420mmL)



REPOSIÇÕES DISPONÍVEI

REF.	mm	Kg	Box	Box	Box	€	REF.	mm	Kg	Box	Box	Box	€
11244	10x11	0.13	5	100	8,50€	11247	16x18	0.30	6	36	14,00€		
11245	12x14	0.18	10	50	9,15€	11248	17x19	0.31	10	36	14,60€		
11246	13x15	0.25	6	36	12,40€	11249	22x24	0.43	5	-	26,50€		

CONJUNTO DE 9 BOCAIS

TORX

REF.	mm	DESCRIÇÃO	Kg	Box	Box	Box	€
53737	90-218mm	CONJUNTO DE 9 BOCAIS TORX (EXTRA LARGOS)	0.42	10	40	1000	12,50€
53739	86-150mm	CONJUNTO DE 9 BOCAIS TORX (ALTOS)	0.32	10	40	960	10,50€
53955	72-170mm	CONJUNTO DE 9 BOCAIS TORX (CURTOS)	0.25	10	40	1480	10,00€



T10, T15, T20, T25, T27, T30, T40, T45, T50

HEXAGONAIS

REF.	mm	DESCRIÇÃO	Kg	Box	Box	Box	€
53738	90-220mm	CONJUNTO DE 9 BOCAIS HEXAGONAIS (EXTRA LARGAS)	0.45	10	40	1000	10,90€
53740	72-170mm	CONJUNTO DE 9 BOCAIS HEXAGONAIS (ALTOS)	0.37	10	40	960	9,10€
53954	43-97mm	CONJUNTO DE 9 BOCAIS HEXAGONAIS (CURTOS)	0.25	10	40	1480	8,50€



1,5, 2, 2,5, 3, 4, 5, 6, 8, 10mm



FERRAMENTAS MANUAIS

51659

59,00€

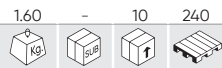

CONJUNTO DE FERRAMENTAS DE 6 CHAVES 12 FACES ARTICULADAS

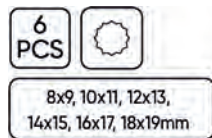

REPOSIÇÕES DISPONÍVEI

REF.	mm	Kg	SUB	QTD	€
10621	8-9	0.09	10	100	9,50€
10622	10-11	0.13	10	100	10,00€
10623	12-13	0.16	5	100	12,60€

50622

64,00€

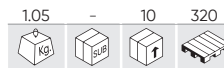

CONJUNTO DE FERRAMENTAS 4 CHAVES ARTICULADAS TORX

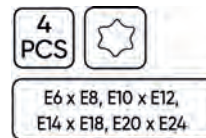

REPOSIÇÕES DISPONÍVEI

REF.	mm	Kg	SUB	QTD	€
10617	E6x E8	0.07	10	100	14,10€
10618	E10x E12	0.11	10	100	15,10€
10619	E14x E18	0.20	10	100	15,70€
10620	E20x E24	0.34	10	100	16,20€

54187

39,30€

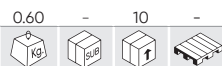

CONJUNTO DE 10 CHAVES PÉ DE GALO 3/8"

REPOSIÇÕES DISPONÍVEI

REF.	mm	Kg	SUB	QTD	€
16010	10	0.04	10	100	4,00€
16011	11	0.04	10	100	4,00€
16012	13	0.04	10	100	4,00€
16013	14	0.05	10	100	4,50€
16014	15	0.05	10	100	4,50€

REF.	mm	Kg	SUB	QTD	€
16015	16	0.05	10	100	5,00€
16016	17	0.05	10	100	5,00€
16017	18	0.06	10	100	5,00€
16018	19	0.06	10	100	5,50€
16019	22	0.08	10	100	6,00€

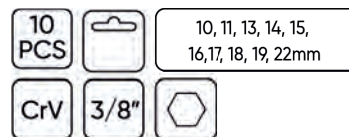

FERRAMENTAS EM POLEGADA

51890

92,00€



CONJUNTO DE 17 CHAVES COMBINADAS - EM POLEGADA

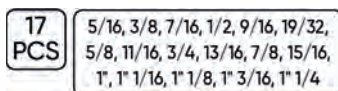

54005

14,00€

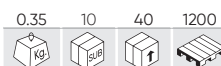

CONJUNTO DE 9 CHAVES UMBRAKO EM POLEGADA

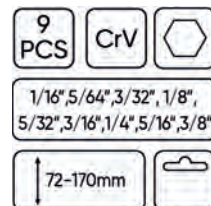

54106

89,00€

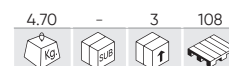

CAIXA DE FERRAMENTAS EM POLEGADAS ZINCADA COM 37 PEÇAS

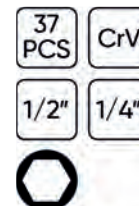

CHAVE DE RODA JUNTA SOLDADA

<p>51661 12,00€</p> <p>1.17 5 20 360</p> <p>1/2" 355mm</p> <p>17, 19, 21mm</p>	<p>52880 42,00€</p> <p>3.75 - 5 120</p> <p>3/4" 700mm</p> <p>24, 27, 32mm</p>	<p>52881 17,00€</p> <p>1.40 - 10 480</p> <p>1/2" 400mm</p> <p>17, 19, 21, 22mm</p>
---	--	---

51416 12,00€

1.05 10 20 360

CHAVE DE RODAS EXTENSÍVEL COM CHAVES REVERSÍVEIS 330-490MM

1/2"

17/19mm
21/23mm

CHAVE INGLESAS

MODELO 1

REF.	DESCRIÇÃO		mm					€
51798	CHAVE INGLESAS 18"		53mm 450mm	1.90	3	12	480	39,60€
52424	CHAVE INGLESAS 24"		62mm 610mm	3.75	-	5	350	64,00€



MODELO 2

REF.	DESCRIÇÃO		mm					€
51795	CHAVE INGLESAS 8"		22mm 200mm	0.28	6	60	3600	9,00€
51796	CHAVE INGLESAS 10"		28mm 250mm	0.48	6	36	2400	14,00€
51797	CHAVE INGLESAS 12"		37mm 300mm	0.71	6	24	960	18,00€



MODELO 3

REF.	DESCRIÇÃO		mm					€
53639	CHAVE INGLESAS 6"		28mm 150mm	0.15	6	96	576	28,60€
53640	CHAVE INGLESAS 8"		30mm 200mm	0.28	6	72	504	34,40€
53641	CHAVE INGLESAS 10"		33mm 250mm	0.50	6	36	1151	41,00€
53642	CHAVE INGLESAS 12"		40mm 300mm	0.83	6	10	1200	54,00€
53643	CHAVE INGLESAS 16"		52mm 400mm	1.53	-	12	336	92,00€
54098	CHAVE INGLESAS 20"		65mm 640mm	2.70	-	6	-	158,50€



53654 81,00€





1.40 - 5 200

CONJUNTO DE CHAVES INGLESAS DE GANCHO

8 PCS 35-60, 60-90, 90-120mm



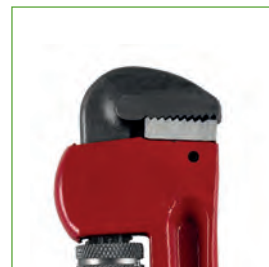

160mm 177mm 250mm

CHAVE DE GRIFO

REF.	DESCRIÇÃO		"					€
52235	CHAVE DE GRIFO 300MM	50mm	12"	0.90	6	24	1140	11,00€
52236	CHAVE DE GRIFO 350MM	60mm	14"	1.09	6	24	760	13,30€
52237	CHAVE DE GRIFO 450MM	70mm	18"	1.75	4	12	720	18,10€
52238	CHAVE DE GRIFO 600MM	75mm	24"	2.50	2	8	600	24,90€
53210	CHAVE DE GRIFO 915MM	110mm	36"	4.95	-	4	96	48,00€







ALUMÍNIO ALLOY CHAVE DE GRIFO

REF.	DESCRIÇÃO		mm					€
53070	ALUMÍNIO ALLOY CHAVE DE GRIFO 12"	45mm	270mm	0.68	6	24	900	16,20€
53071	ALUMÍNIO ALLOY CHAVE DE GRIFO 14"	50mm	320mm	0.92	4	12	900	26,10€
53072	ALUMÍNIO ALLOY CHAVE DE GRIFO 18"	65mm	410mm	1.35	4	12	900	31,60€
53073	ALUMÍNIO ALLOY CHAVE DE GRIFO 24"	75mm	540mm	2.05	2	8	1000	50,00€



SARGENTO

REF.	DESCRIÇÃO					€
52349	SARGENTO 90X200MM	1.25	-	10	480	22,10€
52350	SARGENTO 90X300MM	1.41	-	10	540	22,60€
52351	SARGENTO 90X400MM	1.60	-	10	480	25,40€
52352	SARGENTO 120X300MM	1.99	-	10	360	32,40€
52353	SARGENTO 120X400MM	2.10	-	10	350	33,40€
52354	SARGENTO 120X500MM	2.41	-	6	300	34,40€
52355	SARGENTO 120X600MM	2.62	-	4	300	36,60€
52357	SARGENTO 150X800MM	4.60	-	5	125	54,00€
52358	SARGENTO 150X1000MM	5.35	-	5	120	63,00€



ROQUETE DE 72 DENTES COM CHAVES DE CAIXA

REF.	DESCRIÇÃO					€
54028	ROQUETE DE 72 DENTES - 1/2" COM CHAVES DE CAIXA HEXAGONAIS	1.30	4	24	432	28,00€
54029	ROQUETE DE 72 DENTES - 1/2" COM CHAVES DE CAIXA 12 CANTOS	1.25	4	24	432	28,00€
54030	ROQUETE DE 72 DENTES - 1/4" COM CHAVES DE CAIXA HEXAGONAIS	0.35	6	36	1008	18,80€
54031	ROQUETE DE 72 DENTES - 1/4" COM CHAVES DE CAIXA 12 CANTOS	0.35	6	36	864	19,30€



54028 - 54029	10, 11, 12, 13, 14, 15, 16, 17, 18, 19mm
54030 - 54031	4, 5, 6, 7, 8, 9, 10, 11, 12, 13mm

ROQUETE DE 72 DENTES

CROMADO

REF.	DESCRIÇÃO					€
54022	ROQUETE DE 72 DENTES - 1/4" 145MM COM ACABAMENTO CROMADO	0.15	12	36	1440	9,95€
54023	ROQUETE DE 72 DENTES - 3/8" 200MM COM ACABAMENTO CROMADO	0.30	12	24	1440	13,50€
54024	ROQUETE DE 72 DENTES - 1/2" 255MM COM ACABAMENTO CROMADO	0.60	12	24	960	17,90€



EM EXPOSITOR DE 12 UDS

ZINCADO

REF.	DESCRIÇÃO					€
54018	ROQUETE DE 72 DENTES - 1/4" 145MM COM ACABAMENTO ZINCADO	0.15	12	36	1440	9,85€
54019	ROQUETE DE 72 DENTES - 1/2" 255MM COM ACABAMENTO ZINCADO	0.60	12	24	864	17,90€
54021	ROQUETE DE 72 DENTES - 3/8" 200MM COM ACABAMENTO ZINCADO	0.60	12	24	1440	13,50€



EM EXPOSITOR DE 12 UDS

ROQUETE RETO DE 72 DENTES

REF.	DESCRIÇÃO					€
54083	ROQUETE RETO DE 72 DENTES - 1/4"	0.14	12	24	2592	9,75€
54084	ROQUETE RETO DE 72 DENTES - 3/8"	0.30	12	24	1440	13,10€
54085	ROQUETE RETO DE 72 DENTES - 1/2"	0.60	12	24	960	17,80€



EM EXPOSITOR DE 12 UDS

ROQUETE RETO COMPACTO DE 72 DENTES

REF.	DESCRIÇÃO					€
54086	ROQUETE RETO COMPACTO DE 72 DENTES 1/4"	0.10	12	24	2592	9,25€
54087	ROQUETE RETO COMPACTO DE 72 DENTES - 1/2"	0.50	12	24	1008	17,30€



EM EXPOSITOR DE 12 UDS

FERRAMENTAS MANUAIS

52197

36,30€

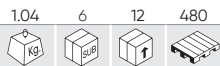

ROQUETE ARTICULADA EXTENSÍVEL DE 1/2" 72 DENTES

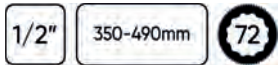

EM EXPOSITOR DE 6 UDS

52207

24,20€



ROQUETE MINI DE 72 DENTES - 1/4" 85MM COM ACABAMENTO ZINCADO



EM EXPOSITOR DE 12 UDS

ROQUETE DE 72 DENTES ARTICULADA

REF.						€
52587	1/4" 172mm	0.16	12	144	3456	39,90€
52588	1/2" 172mm	0.17	12	144	3456	45,00€



EM EXPOSITOR DE 12 UDS



ROQUETE DE 72 DENTES ARTICULADA

REF.						€
51305	1/2" 175mm	0.31	12	48	816	28,90€
51306	1/4" 165mm	0.30	12	48	816	28,10€



EM EXPOSITOR DE 12 UDS



ROQUETE DE 72 DENTES COM CABEÇA GIRATÓRIA

REF.						€
51405	1/4" 145mm	0.58	12	24	-	21,10€
51406	1/2" 280mm	0.66	12	24	864	29,20€



EM EXPOSITOR DE 12 UDS



ROQUETE EXTENSÍVEL 72 DENTES

REF.						€
51307	1/2" 305-445mm	0.92	6	12	360	29,70€
53346	1/4" 150-200mm	0.25	6	12	-	18,00€
54304	1/2" 450-610mm	1.15	-	6	480	26,00€



EM EXPOSITOR DE 6 UDS



CATRACA LONGADA DE 72 DENTES

REF.	DESCRIÇÃO					€
53886	1/4" 305mm	0.27	10	40	1680	20,30€
53887	3/8" 457mm	0.68	10	20	700	30,30€
53888	1/2" 609mm	1.27	4	16	480	37,90€



REPUEST

REF.	"					€
15147	3/8"	0.10	-	100	-	5,00€

REF.	"					€
15148	1/2"	0.20	-	100	-	5,00€

REF.	"					€
15149	1/4"	0.05	-	100	-	5,00€



51801 62,00€

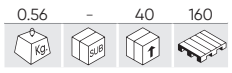

ROQUETE FLEXÍVEL DE 72 DENTES DE 3/8" 500MM



IDEAL PARA LOCAIS DE DIFÍCIL ACESSO

É OPERADO PELA ALÇA

COM CABEÇA GIRATÓRIA



53671 41,00€

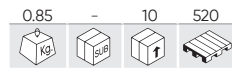

CONJUNTO DE 3 ROQUETES CURTOS 1/4" 1/2" 3/8"

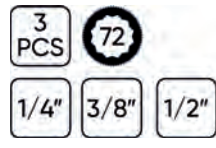

KIT DE REPARO PARA CHAVE CATRACA

REF.	DESCRIÇÃO					€
15138	1/4"	0.10	-	50	-	10,50€
15139	3/8"	0.15	-	50	-	12,00€
15140	1/2"	0.20	-	50	-	13,50€

54339 273,00€

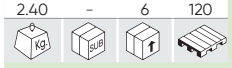

CHAVE DINAMOMÉTRICA DIGITAL 1/2" 10-200NM



N

52913 292,00€

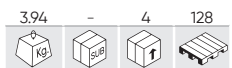

CHAVE DINAMOMETRICA COM CABEÇA INTERCAMBIÁVEL, 200NM

1/2"

	x1	1/2"
	x9	13, 14, 15, 17, 19, 22, 24, 27, 30mm
	x1	40-200Nm

- Certificado de calibração de fábrica incluído.



54269 56,00€



CONJUNTO DE 21 PEÇAS COM CHAVE DINAMOMÉTRICA DE 1/4 DE POLEGADA

1/4" N

	x1	5-25Nm		x3	PH1, PH2, PH3
	x1	100mm		x8	H2, H2.5, H3, H4, H5, H6, H8, H10 (37mmL)
	x1	UNIVERSAL		x1	H5 (87mmL)
	x1	1/4" (F) - 3/8" (M)		x5	T10, T15, T20, T25, T30



53972

550,00€



CHAVE DINAMOMÉTRICA 3/4"

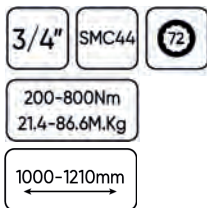

- Certificado de calibração de fábrica incluído.

CHAVE DE TORQUE COM O APROFUNDAMENTO

REF.	DESCRIÇÃO	kg	box	box	box	box	€
53081	1/4" 4-20NM (36T)	375mm	1.10	5	25	350	115,00€
53082	1/2" 40-210NM (24T)	560mm	1.90	4	8	168	148,00€

- Certificado de calibração de fábrica incluído.



CHAVE DINAMOMÉTRICA

REF.	DESCRIÇÃO	kg	box	box	box	box	€
51127	1/2" 28-210NM	470mm	1.70	4	8	256	56,00€
51262	1/4" 5-25NM	270mm	0.80	4	16	384	51,00€
51338	3/8" 19-110NM	365mm	1.05	4	16	384	53,00€



KIT DE REPARAÇÃO

REF.	"	kg	box	box	box	box	€	REF.	"	kg	box	box	box	box	€	REF.	"	kg	box	box	box	box	€
51127R	1/2"	0.15	-	20	-	-	14,00€	51262R	1/4"	0.05	-	20	-	-	14,00€	51338R	3/8"	0.05	-	20	-	-	14,00€



51830

94,00€



CHAVE DINAMOMÉTRICA MECÂNICA

- Exactitude: CW: +/- 4%
- Alcance de operação: 2-10 N-m
- Unidades de selecção: N-m, in-lb.
- Comprimento (mm): 242mm
- Dedo: 1/4"
- Vida útil: 2000 ciclos

- Certificado de calibração de fábrica incluído.



ADAPTADOR DE ENCAIXE

REF.	DESCRIÇÃO	kg	box	box	box	box	€
53468	1/2" 250mm	0.35	6	48	600	8,50€	
53478	1/4" 115mm	0.50	5	100	1200	4,55€	
53479	3/8" 200mm	0.15	5	50	300	6,40€	
53480	3/4" 460mm	1.35	5	10	440	19,90€	
53481	1" 550mm	2.85	-	5	300	27,40€	



CHAVE ARTICULADA

REF.	DESCRIÇÃO						€
52524	3/4" 1020mm	3.60	3	6	144		51,00€
52526	1/2" 600mm	1.65	5	10	600		28,40€
52525	1/2" 430mm	0.85	10	20	1500		13,80€



REPUEST

REF.	"					€
11945	1/2"	0.15	25	100	-	7,00€

PARA 52526

REF.	"					€
11946	1/2"	0.06	25	300	-	4,50€

PARA 52525

REF.	"					€
11947	3/4"	0.51	10	40	960	19,00€

PARA 52524



54343

31,00€

1.15	-	6	594
------	---	---	-----

BARRA DE TORÇÃO EXTENSÍVEL DE 1/2 POL. 450-600 mm



51479

31,80€

0.65	12	24	1056
------	----	----	------

EXTENSOR DE 1/2" COM PÉ REDONDO



EM EXPOSITOR DE 12 UDS



51805

17,00€

0.33	4	20	640
------	---	----	-----

KIT EXTENSOR DE 1/4" COM PÉ REDONDO



51447

16,00€

0.34	5	20	960
------	---	----	-----

MÓDULO DE EXTENSÕES DE 1/4" COM CABEÇA NORMAL



51448

52,00€

2.38	-	5	300
------	---	---	-----

MÓDULO DE EXTENSÕES DE 1/2" COM CABEÇA DE ESFERA



REPOSIÇÕES DISPONÍVEI

REF.	mm				€
12995	50	0.03	5	100	7,00€
12996	75	0.04	20	100	7,00€
12997	100	0.06	20	100	7,50€
12998	152	0.08	5	100	9,00€
12999	227	0.11	5	100	9,50€

REPOSIÇÕES DISPONÍVEI

REF.	mm				€
14026	50	0.03	10	100	5,50€
14027	75	0.04	-	50	5,60€
10264	100	0.05	10	100	2,00€
14029	152	0.07	-	50	8,50€
14030	227	0.11	-	50	9,50€

REPOSIÇÕES DISPONÍVEI

REF.	mm				€
14978	50	0.10	5	100	7,50€
14979	125	0.20	5	50	9,00€
14980	250	0.40	5	25	13,00€
14981	380	0.60	5	20	22,50€
14982	510	0.60	5	10	27,50€

54302

11,50€

0.45	10	40	650
------	----	----	-----

CONJUNTO COM 6 CHAVES DE FENDA DE PRECISÃO

x3
 x3



FERRAMENTAS MANUAIS

52500

19,00€

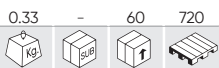

KIT DE 8 CHAVES CURTAS

8 PCS



CONTÉM

- ⊕ x3 PH00x25, PH0x25, PH1x25
- ⊖ x5 SL0.4x2x25, SL0.4x2.5x25, SL0.5x3x.25, SL0.5x3.5x25, SL0.8x4x25

53917

9,00€

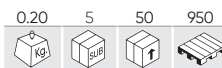

JOGO DE 7 CHAVES LONGAS

7 PCS



CONTÉM

- ⊕ x3 PH00, PH0, PH1
- ⊖ x4 SL.1.4, SL2.0, SL.2.4, SL3.0

53694

18,40€



CHAVE DE IMPACTO DE 1/2"

8 PCS CrV 1/2"



CONTÉM

- ⊕ x1 1/2"
- ⊖ x1 1/2" - 8mm
- ⊕ x3 PH 2x36mm, 3x36mm, 3x70mm
- ⊖ x3 SL 7x36mm, 8x36mm, 8x70mm

54126

39,00€



KIT DE 12 CHAVES DE FENDA DE IMPACTO

12 PCS GO-THROUGH



CONTÉM

- ⊕ x6 PH0x75mm, PH1x75mm, PH2x38mm, PH2x100mm, PH3x125mm, PH4x200mm
- ⊖ x6 SL3.2x75mm, SL5x75mm, SL6x38mm, SL6x100mm, SL8x150mm, SL9.5x200mm

53010

18,00€

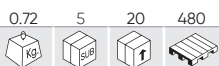

KIT DE DESTORNILLADORES COM CABO INTERCAMBIÁVEL 20 EM 1

11 PCS



CONTÉM

- ⊕ x2 PH1, PH2
- ⊖ x2 4x6, 5x7mm
- ⊕ x3 T10x15, T20x25, T30x40
- ⊕ x3 H4x4mm, H5x5mm, H6x6mm
- x1

50902

13,00€



JOGO DE 4 CHAVES DE FENDA DE IMPACTO

4 PCS 3", 4", 6", 8"



CHAVE DE FENDA EVA - ACABAMENTO DE CARBONO

53943

21,50€

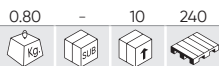

- ⊕ PH4x200, PH3x150, PH2x100, PH2x38, PH1x80, PH0x120, PH1x100

53944

19,50€

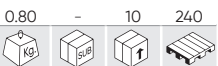

- ⊖ SL9x200, SL4x125, SL5x100, SL5x80, SL6x38, SL6x100, SL8x150mm

53945

18,90€

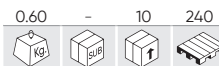

- ⊕ T8x75, T9x75, T10x75, T15x75, T20x75, T25x100, T27x100

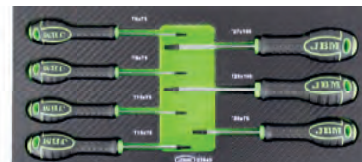
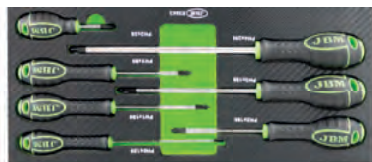

54060

6,00€

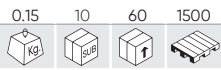

CHAVE COM MULTIFUNÇÃO ESTRELA E FENDA 6X150MM



54061

6,00€

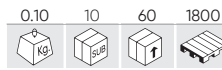

CHAVE COM MULTIFUNÇÃO ESTRELA E FENDA 6X100MM

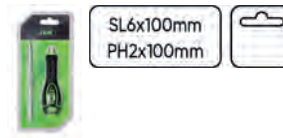

54071

26,50€

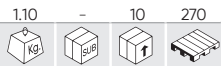

KIT DE 6 CHAVES DE FENDA GO-THROUGH (3 CRUZADAS + 3 PLANAS)



CONTÉM

- ⊕ x3 PH3x150, PH2x100, PH1x75mm
- ⊖ x3 SL8x150, SL6.5x100, SL5.5x75mm

54070

18,00€

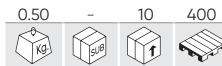

CONJUNTO DE 6 CHAVES DE FENDA (2 CRUZADAS + 4 PLANAS)



CONTÉM

- ⊕ x2 PH1x80, PH2x100mm
- ⊖ x4 SL6.5x150, SL5.5x125, SL4x100, SL3x80mm

52170

16,00€

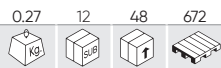

CHAVE FLEXÍVEL

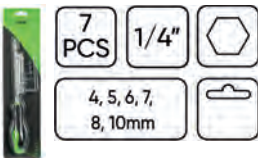

52169

25,00€

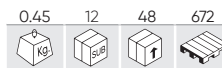

JOGO DE 3 CHAVES FLEXÍVEIS

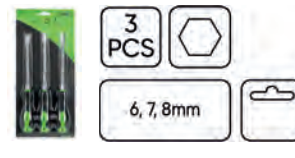

53575

16,00€



CHAVE FLEXÍVEL



- x3 1/4" 4 mm
- 5 mm
- 7 mm

FERRAMENTAS MANUAIS

53225

3,50€

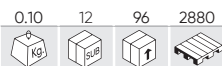

MAGNETIZADOR/DESMAGNETIZADOR



51812

46,00€

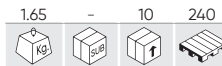

JOGO DE 5 ALICATES (EM ESTOJO)



CONTÉM

A	x1	160mm
B	x1	160mm
C	x1	180mm
D	x1	200mm
E	x1	250mm

ALICATE SEEGER BOCA RETA



PARA INTERIORES

REF.	DESCRIÇÃO					€
51018	7" 180mm	0.14	5	100	1800	7,05€
52964	9" 225mm	0.23	6	60	1440	9,45€
53549	13" 330mm	0.45	5	30	-	14,30€



PARA EXTERIORES

REF.	DESCRIÇÃO					€
51017	7" 180mm	0.17	5	100	1800	6,80€
52966	9" 225mm	0.28	6	60	1800	9,45€
53547	13" 330mm	0.50	5	30	-	14,70€



ALICATE SEEGER BOCA CURVA



PARA INTERIORES

REF.	DESCRIÇÃO					€
51021	7" 180mm	0.16	5	100	-	7,05€
52965	9" 225mm	0.24	6	60	1440	9,20€
53550	13" 330mm	0.45	5	30	-	14,70€



PARA EXTERIORES

REF.	DESCRIÇÃO					€
51020	7" 180mm	0.13	5	100	1600	6,65€
52967	9" 225mm	0.24	6	60	1440	9,40€
53548	13" 330mm	0.50	5	30	-	15,60€



ALICATE DE CORTE DIAGONAL

REF.	DESCRIÇÃO					€
53905	6" 160mm	0.20	6	60	1440	7,30€
53906	7" 180mm	0.20	6	60	1560	8,65€



ALICATE DE PONTA ALARGADA

REF.	DESCRIÇÃO					€
53908	6" 160mm	0.15	6	60	1440	7,25€
53909	8" 200mm	0.20	6	60	1440	9,70€



ALICATE UNIVERSAL

REF.	DESCRIÇÃO						€
53911	6" 160mm	0.20	6	60	1440		8,80€
53967	8" 200mm	0.30	6	60	1440		10,20€
54015	7" 180mm	0.20	6	60	1920		10,20€



15454

35,40€

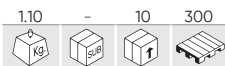

8"

MÓDULO EVA DE ALICATES SEGER 8"

REF.	DESCRIÇÃO						€
10526	ALICATE SEEGER PARA INTERIORES BOCA RETA 8"	0.21	5	50	-		10,00€
10642	ALICATE SEEGER PARA EXTERIORES BOCA RETA 8"	0.22	5	50	-		10,00€
10643	ALICATE SEEGER PARA INTERIORES BOCA CURVA 8"	0.21	5	50	-		10,00€
10644	ALICATE SEEGER PARA EXTERIORES BOCA CURVA 8"	0.22	5	50	-		10,00€



53389

31,50€

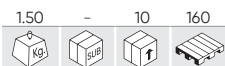

KIT DE ALICATES SEEGER COM PONTA INTERCAMBIÁVEL



ALICATE EXTENSÍVEL

REF.								€
52052	515mm	140mm	1.88	5	10	400		53,00€
50567	250mm	40mm	0.34	10	60	1500		9,60€



52846

37,80€



ALICATE EXTRA-LONGO RETO



52847

41,00€



ALICATE EXTRA LONGO CURVADO 45°



52272

24,60€



JOGO ALICATES PONTA 0°, 45°, 90°



FERRAMENTAS MANUAIS

53390

34,50€

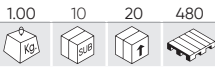

ALICATE PARA ABRAÇADEIRAS



REF.	DESCRIÇÃO					€
14180	CONJUNTO DE PEÇAS DE REPOSIÇÃO PARA 53390	0.01	-	100	-	7,90€

51995

24,50€

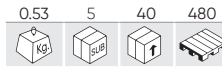

ALICATE PARA ABRAÇADEIRAS



REF.	DESCRIÇÃO					€
14179	CONJUNTO DE PEÇAS DE REPOSIÇÃO PARA 51995	0.01	-	100	-	8,50€

53396

18,30€

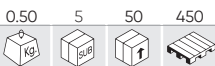

ALICATE PARA ABRAÇADEIRAS DE TUBOS DE ESCAPE

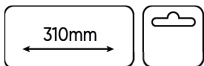

52791

18,00€

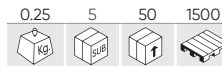

ALICATE PARA ABRAÇADEIRAS CLIC-R

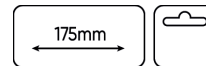

54376

12,00€

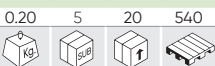

FERRAMENTA PARA ABRAÇADEIRA DA COIFA DA JUNTA HOMOCINÉTICA COM CORTADOR

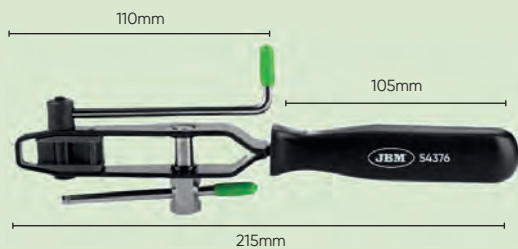

54311

13,00€



ALICATE PARA ABRAÇADEIRAS



54330

12,50€



ALICATE DE VEDAÇÃO DA HASTE DA VÁLVULA

280 mm

OPEL, VW, FORD



54279

6,00€



ALICATES PARA EXTRAÇÃO DE LÂMPADAS



54479 36,50€

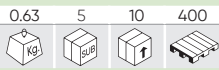

N

ALICATE PARA CINTAS METÁLICAS COM TRAVAMENTO AUTOMÁTICO



52412 5,00€

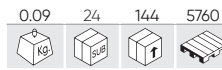

MINI ALICATE MULTIUSOS 105MM

CONTÉM

- x2 Chaves de fenda plano
- x1 Ponta estrela
- x1 Saca-rolhas
- x1 Abre-latas
- x1 Lima 25mm
- x1 Folha de serra 40mm
- x1 Folha de corte 40mm



52050 98,00€

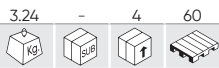

JOGO DE ALICATES PARA ABRAÇADEIRAS

REPOSIÇÕES DISPONÍVEI

REF.	DESCRIÇÃO	Kg	Sub	Alt	Compr	€
A 13707	ALICATE PARA BRAÇADEIRAS ELÁSTICAS COM PONTA GIRATÓRIA	0.25	10	40	-	14,00€
B 13708	ALICATE PARA BRAÇADEIRAS ELÁSTICAS	0.24	6	48	-	14,00€
C 13709	ALICATE PARA BRAÇADEIRAS ELÁSTICAS COM PONTA RECTA	0.24	6	48	576	14,00€
D 13710	ALICATE PARA BRAÇADEIRAS ELÁSTICAS 45°	0.70	6	48	1536	14,00€
E 13712	ALICATE PARA LA EXTRAÇÃO DE TUBOS	0.21	10	40	-	14,00€
F 51995	ALICATE PARA ABRAÇADEIRAS	0.53	5	40	480	24,50€
G 52791	ALICATE PARA ABRAÇADEIRAS CLIC-R	0.25	5	50	1500	18,00€



52619 23,10€

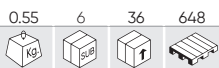

ALICATE PARA ABRAÇADEIRAS



Furros 1/2" lida para utilizar como uma chave
Abertura: 0-20mm



52812 65,00€

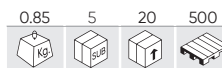

ALICATE PARA ABRAÇADEIRAS



Soquete feminino de 3/8" para apertar con roquete.
Abertura: 34mm



53487 16,70€

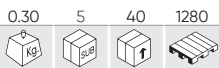

CLEȘTE PENTRU TUB DE COMBUSTIBIL



52508 38,40€

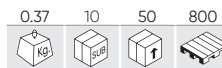

ALICATE ABRAÇADEIRAS



COM ANTIBLOQUEIO

52509 36,20€

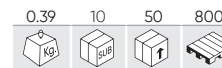

FERRAMENTAS MANUAIS

52625

9,00€

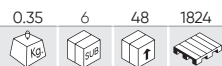

ALICATE PARA MOLAS DE TRAVÃO



51355

19,00€

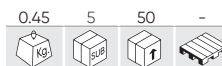

ALICATES DE EQUILÍBRIO DE PESO



52982

53,00€

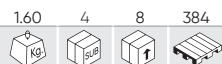

JOGO 3 MORDAÇAS DE PRESSÃO EXTRA-LARGAS



53445

17,10€

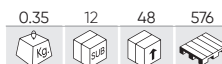

JOGO DE ALICATES PARA DESCONEXÃO DO TUBO DE COMBUSTÍVEL



x1 5/16" Ø 8mm

x1 3/8" Ø 10mm

x1 APLICAÇÃO ESPECIAL



51972

12,00€

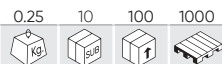

ALICATE PARA DESENCAPAR FIOS AUTO-AJUSTAVÉL



0.25~2.5mm²

08-6mm



52152

13,50€

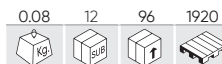

TESOURAS DE ELECTRICISTA ZEBRA

ACERO INOXIDABLE
STAINLESS STEEL

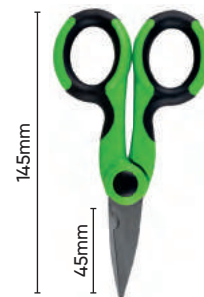

53411

5,00€

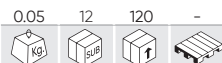

ALICATES DE DESENCAPAR MINI



53412

4,00€

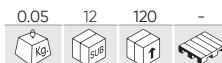

ALICATES DE DESENCAPAR MINI



ALICATES DE DESENCAPAR MINI

REF.	DESCRIÇÃO					€
53602	360mm - Ø 125mm ²	0.60	-	5	300	30,50€
53603	550mm - Ø 250mm ²	1.75	-	5	300	45,00€
53604	800mm - Ø 500mm ²	3.70	-	5	120	118,00€



CORTA CAVILHAS

REF.	DESCRIÇÃO					€
52955	12" - 300mm	0.77	-	20	200	19,80€
52956	14" - 350mm	0.95	-	20	200	19,60€
52957	18" - 450mm	1.47	-	10	360	23,80€
52958	24" - 600mm	2.40	-	8	210	28,20€
52959	30" - 750mm	3.78	-	5	100	42,00€
52960	36" - 900mm	5.15	-	5	105	46,00€



53385 19,30€

0.15	6	54	1026
------	---	----	------



ALICATE PARA EXTRAÇÃO DE GRAMPOS DE CARROCERIA



53976 9,00€

0.20	6	60	1440
------	---	----	------



ALICATE DE PONTA ESPECIAL TERMINAIS 6" - 160MM



52761 8,00€

0.25	12	72	1800
------	----	----	------



ALICATE PARA TERMINAIS ISOLADOS E NÃO ISOLADOS 9"



53932 8,00€

0.25	12	72	1296
------	----	----	------



ALICATE PARA TERMINAIS PRÉ-ISOLADOS E NÃO ISOLADOS 9"



52762 9,00€

0.25	12	72	1800
------	----	----	------



ALICATE PARA TERMINAIS NÃO ISOLADOS 8-3/4"

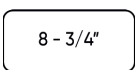

16111 19,20€

0.61	-	10	200
------	---	----	-----



MÓDULO EVA PARA DECAPAR CABOS E TERMINAIS



54254

43,00€

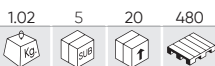

ALICATE DE TERMINAIS COM PONTA INTERCAMBIÁVEL

7 PCS

CONTÉM

- ALICATE DE 9"
- PONTA DE 0,15 - 6 MM°
- PONTA DE 10 - 35 MM°
- PONTA DE 0,5 - 6 MM°
- PONTA DE 0,5 - 10 MM°
- PONTA DE 0,5 - 4 MM°
- CHAVE DE FENDA PH2X150



54112

18,00€

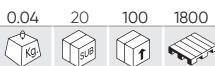

EXTRATOR DE TERMINAIS COM SEIS CONECTORES

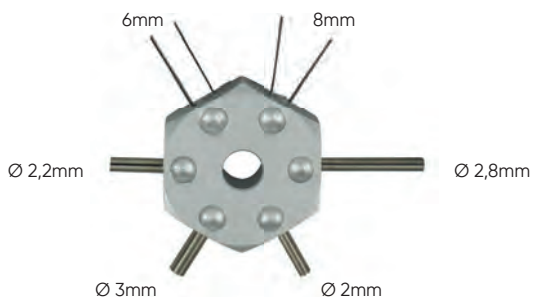

54142

15,20€



CONJUNTO DE GANCHO, PICARETA E PÉ DE CABRA (6 PCS)

6 PCS

CONTÉM

- 2 pontas de gancho
- 2 pontas retas
- 2 pontas anguladas
- 6 pontas com alavancas



PESCA PEÇAS FLEXÍVEL

REF.	DESCRIÇÃO	Ø	—					€
51525	PESCA PEÇAS FLEXÍVEL COM PONTA MAGNÉTICA	A	7mm	500mm	0.14	10	60 960	9,80€
51526	PESCA PEÇAS FLEXÍVEL COM PONTA DE 4 GARRAS	B	20mm	500mm	0.10	12	144 2016	9,80€
52473	PESCA PEÇAS MAGNETICO COM LED NA PONTA	C	15mm	545mm	0.18	10	60 960	9,90€

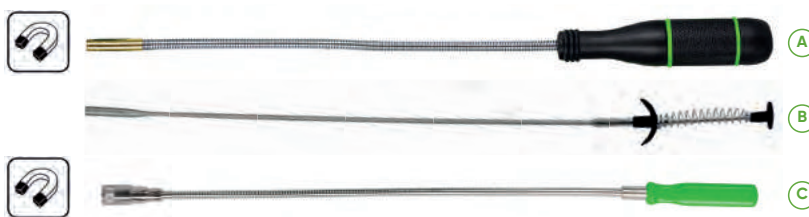

FERRAMENTAS DE INSPEÇÃO

REF.	DESCRIÇÃO	Ø	—					€
51272	PESCA PEÇAS MAGNÉTICO COM PONTA DE LED	A	18mm	90-810mm	0.05	12	72 1512	7,50€
52472	PESCA PEÇAS MAGNÉTICO EXTENSÍVEL	B	10mm	135-600mm	0.15	12	108 4320	4,90€
52468	ESPELHO TELESCÓPICO ARTICULADO	C	50mm	280-445mm	0.09	12	48 1536	5,90€



15706

31,00€

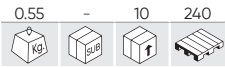

MÓDULO DE GRIP
MAGNÉTICO - 5 PEÇAS



15799

28,30€



MÓDULO DE
MARTELOS - MÓDULO
DE FIBRA DE
CARBONO EM EVA



MARTELO PROFISSIONAL CON PUNHO DE FIBRA

REF.	DESCRIÇÃO					€
52182	2Kg - 297mm	2.20	6	12	504	24,00€
52184	4Kg - 880mm	4.31	-	4	128	43,00€
52185	6Kg - 895mm	6.97	-	4	72	55,00€
52186	8Kg - 900mm	8.68	-	2	72	72,00€



MARTELOS NYLON ANTI-RETROCESSO

REF.	DESCRIÇÃO					€
52425	Ø 40mm	0.70	6	12	768	33,30€
52426	Ø 60mm	1.50	2	12	288	52,00€
52427	Ø 70mm	2.02	2	12	204	64,00€



PUNTA RECAMBIO

REF.	mm					€	REF.	mm					€	REF.	mm					€
11212	Ø 40	0.02	5	100	-	5,00€	11213	Ø 60	0.08	5	50	-	10,60€	11214	Ø 70	0.11	5	50	-	12,50€



EN CUNHA

REF.	DESCRIÇÃO					€
51674	505g	0.60	6	36	864	7,75€
52565	1000g	1.13	6	24	720	11,50€



MARTELO FORMA DE BOLA

REF.	DESCRIÇÃO					€
51504	454g	0.55	4	40	800	8,50€
51918	1000g	1.25	6	18	648	12,50€



MARTELOS PROFISSIONAIS ANTI-RETROCESSO

REF.	DESCRIÇÃO					€
52180	1,35Kg - 355mm	1.45	6	12	432	19,00€
52181	1,80Kg - 370mm	1.81	6	12	300	22,50€
52183	2,20Kg - 405mm	2.30	6	12	288	26,20€



MACHADO COM CABO DE MADEIRA

REF.	DESCRIÇÃO					€
52188	360mm	0.82	4	24	875	15,50€
52460	410mm	1.17	4	24	864	16,60€
52461	700mm	2.00	4	12	240	25,70€



FERRAMENTAS MANUAIS

52830

24,00€

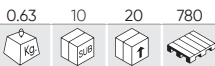

SERRA COM CABO ERGONÔMICO



EM EXPOSITOR DE 10 UDS

52831

18,00€

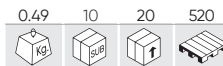

SERRA



EM EXPOSITOR DE 10 UDS

REF. DESCRIÇÃO

12060 FOLHA PARA SERRA REF.52830 + 52831 + 51675

0.02 100 800 - 2,50€

53591

5,50€

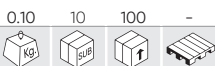

STRIPPER PARA A REMOÇÃO DE ISOLAMENTO DE FIOS

- Faixa de corte: 8-28mm.
- Comprimento do produto: 170 mm.
- Comprimento da tela: 20mm.
- Profundidade do gancho: 5mm.



52786

14,60€

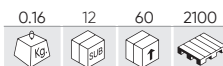

NAVALHA COM FUNÇÃO CORTA-CINTOS E PONTEIRA QUEBRA-VIDROS



EM EXPOSITOR DE 12 UDS

CORTA TUBOS

REF.	DESCRIÇÃO	kg	L	cm	mm	€
52878	3-32mm	0.22	10	50	1500	11,20€
52879	3-35mm	0.24	10	50	1500	10,10€
52877	Ø MAX: 42mm	0.43	6	48	624	15,80€
53517	Ø MAX: 30mm	0.13	10	60	600	9,50€



52885

18,00€

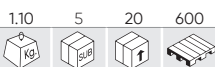

KT DE 12 VAZADORES - METRICO

12 PCS

3, 4, 5, 6, 7, 8, 9, 10, 12, 14, 16, 19mm



54331

27,00€

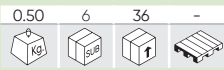

N

CONJUNTO DE 3 CORTADORES PROFSSIONAIS



	LÂMINA	TAMANHO LÂMINA	COMPRIMENTO	PESO	
A	x4		60x19mm	175mm	115,5g
B	x1		100x10mm	160mm	129,7g
C	x4		60x19mm	175mm	115,5g



REPOSIÇÕES DISPONÍVEI

REF.	DESCRIÇÃO				€
16342	CONJUNTO DE 10 LÂMINAS DE CORTE PARA REF.54331	0.01	10	100	2,50€
16343	CONJUNTO DE 10 LÂMINAS DE CORTE TRAPEZOIDAIS PARA REF.54331	0.01	10	100	2,50€

51909

2,46€

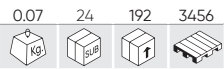

CORTADOR PROFSSIONAL

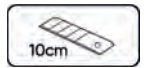

EM EXPOSITOR DE 24 UDS



REPOSIÇÕES DISPONÍVEI

REF.	DESCRIÇÃO				€
16642	CONJUNTO DE 10 LÂMINAS DE CORTE PARA REF.51909	0.01	10	100	1,00€

ESCOPRO

REF.	DESCRIÇÃO					€
53120	150mm	0.35	6	24	1200	6,00€
53121	250mm	0.55	6	24	864	7,35€
53122	350mm	0.90	6	12	720	9,50€



ACERO 45C

53083

64,00€

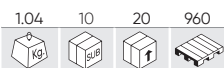

KIT DE 4 CINZÉIS

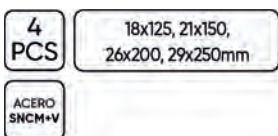

54089

17,50€



KIT DE 5 CINZÉIS

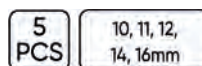

REPOSIÇÕES DISPONÍVEI

REF.	mm				€
15783	155x10	0.09	6	24	3,50€
15784	155x11	0.09	6	24	3,50€
15785	155x12	0.09	6	24	3,50€
15786	155x14	0.09	6	24	3,50€
15787	155x16	0.09	6	24	3,50€



FERRAMENTAS MANUAIS

53095

20,50€

0,75 6 24 1080



KIT DE 6 PONTEIROS



54099

13,80€

0,45 10 40 2240



KIT DE 5 PONTEIROS

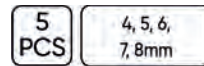

15737

45,00€

1,70 - 10 200



MÓDULO DE CINZÉIS E PONTEIROS

9 PCS

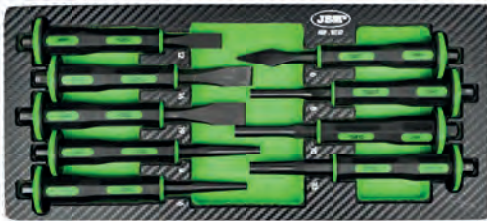

52049

14,00€

0,40 10 40 3840



KIT DE 5 PUNÇÕES CÔNICOS



13667

17,60€

0,83 - 10 360



MÓDULO EVA DE REBITADEIRA E REBITES



53993

77,00€

1,95 5 20 240



REBITADEIRA ARTICULADA MULTIFUNÇÃO

- Cabeça giratória de 360°
- Compacto, permite que você trabalhe facilmente em pequenos espaços
- O desenho permite o trabalho com uma mão

CONTÉM

- Brocas de rebite padrão 2,4 mm (3/32") - 3,2 mm (1/8") - 4,0 mm (5/32") - 4,8 mm (3/16")
- Perfuradores para porcas de rebite M3x0,5 - M4x0,7 - M5x0,8 - M6x1
- Perfuradores para rebites M6x1 - M5x0,8 - M4x0,7
- 3 chaves 5,5x8,5mm - 12x17mm - 15x19mm
- Suporte de fuso M6x1 - M5x0,8 - M4x0,7 - M3x0,5"



52596

114,00€

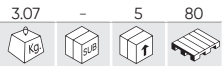

REBITADEIRA DE PORCA 400MM/16"

400mm 16"

M3, M4, M5, M6, M8, M10, M12



52597

146,00€

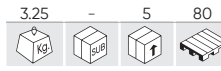

ALICATE DE REBITAR AUTOMATICO 440MM / 17"

440mm 17"

M3, M4, M5, M6, M8, M10, M12



PEÇA DE REPOSIÇÃO PARA 52595, 52596, 52597

REF.	DESCRIÇÃO				€
13226	M3	0.03	-	100	4,50€
13227	M4	0.04	20	100	4,50€
13228	M5	0.04	20	100	4,50€
13229	M6	0.04	20	100	4,50€

REF.	DESCRIÇÃO				€
13230	M8	0.04	20	100	4,50€
13231	M10	0.05	-	100	4,50€
13232	M12	0.05	-	100	4,50€



52463

26,10€

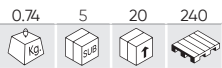

REBITADEIRA 300MM / 12"

300mm 12"

3,2mm (1/8), 4,0mm (5/32), 4,8mm (3/16)



52464

42,00€

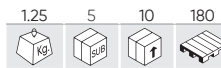

REBITADEIRA 400MM/16"

400mm 16"

2,4mm (3/32), 3,2mm (1/8), 4,0mm (5/32), 4,8mm (3/16), 6,4mm (1/4)



53331

31,80€

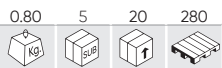

REBITADEIRA DE EMPURRAR 10" 250MM

250mm 10"

2,4mm (3/32), 3,2mm (1/8), 4,0mm (5/32), 4,8mm (3/16), 6,4mm (1/4)



53332

34,50€

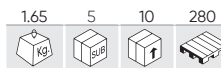

REBITADEIRA EXTENSÍVEL 8" 200MM

200mm 8"

2,4mm (3/32), 3,2mm (1/8), 4,0mm (5/32), 4,8mm (3/16), 6,4mm (1/4)



FERRAMENTAS MANUAIS

52595

64,00€

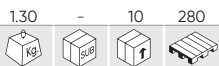

REBITADEIRA COMPACTO 200MM / 8"

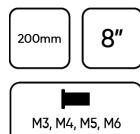

52462

25,30€



REBITADEIRA COMPACTO 200MM / 8"



52609

29,00€

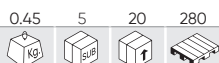

REBITADEIRA + CAIXA DE REBITES PLÁSTICOS

Ø 6,6mm x 17,2mm (10u.)
Ø 6,3mm x 25,2mm (10u.)
Ø 5mm x 17,2mm (10u.)
Ø 5mm x 15,8mm (10u.)



REPOSIÇÕES DISPONÍVEI

REF.	Ø	KG	SUB	HT	LN	€
13674	6x19,3mm	0.04	25	2500	0,50€	
13675	6x17,8mm	0.01	25	500	0,50€	
13676	6x25,5mm	0.01	100	1000	0,50€	
13677	6x24,5mm	0.03	25	1000	0,50€	
13678	6x24mm	0.01	25	1000	0,50€	

52575

119,00€



REBITADOR PNEUMÁTICO



- Tamanho: 3/16" - 5/32" - 1/8" - 3/32".
- Tração: 1586lbs / 720 kgs.
- Rod: 9/16" - 14mm.
- Binário max. 60FT IB / 23-69NM.
- Entrada de ar: 1/4".
- Consumo de ar médio: 0.03Cfm/0.86L/min.

CONTÉM

- 2 Multi-tool
- Quick
- O-rings



NÍVEL

DE ALUMÍNIO

REF.	DESCRIÇÃO	KG	SUB	HT	LN	€
53613	500mm	0.55	5	30	1260	19,50€
53614	600mm	0.60	5	30	840	21,50€
53615	800mm	0.85	5	20	600	34,60€



TUBULAR MAGNETIZADO

REF.	DESCRIÇÃO	KG	SUB	HT	LN	€
53616	500mm	0.30	5	60	1260	10,40€
53617	600mm	0.30	5	60	840	9,25€
53618	800mm	0.35	5	30	600	13,90€

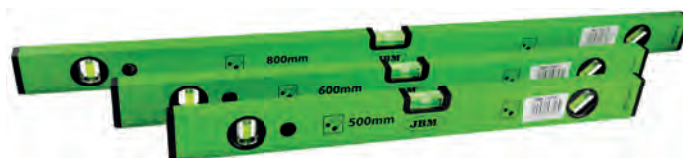

EXPOSITOR PARA NIVELES

REF.	KG	SUB	HT	LN	€
14183	0.80	-	10	-	31,00€



CINTA MÉTRICA

REF.	DESCRIÇÃO					€
53025	3m x 16mm	0.13	12	48	2016	3,50€
53026	5m x 25mm	0.26	12	48	2016	5,80€
53027	7,5m x 25mm	0.40	12	48	1500	9,00€



EM EXPOSITOR DE 12 UDS

52433 4,80€

0.10	10	50	1820

APALPA FOLGAS, -20 (0.05-1.0 MM)

0,05-1mm



52638 9,95€

0.35	5	50	1800

ALICATE PERFORADORA ROTATIVA

Ø 2, 2.5, 3, 3.5, 4, 4.5mm



52318 73,00€

0.64	6	24	336

COMPROVADOR ANGULAR MAGNÉTICO

-6° / +6°



52904

2.00	-	5	175

CALIBRE DE PROFUNDIDADE COM SUPORTE MAGNÉTICO

61,00€



REF.	DESCRIÇÃO					€
13704	CALIBRE DE PROFUNDIDADE PARA REF. 52904	0.10	-	50	1500	21,00€

PÉ DE REI

REF.				€
50724	0.30	5	50	28,00€
50937	0.24	10	50	10,50€



150mm

50724 DIGITAL

50937 MECANICO

CALIBRE DE PROFUNDIDADE

REF.				€
52873	0.04	5	300	11,00€
53042	0.05	10	100	9,90€



52873 MECANICO

53042 DIGITAL

GONIOMETRO

REF.				€
52583	0.20	4	48	8,50€
52794	0.48	6	24	28,00€



52583

52794 MAGNÉTICO

FERRAMENTAS MANUAIS

51951

15,60€

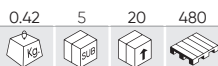

KIT DE 3 ESPÁTULAS DE AÇO



53339

9,50€

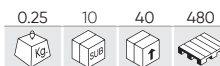

KIT DE 4 ESPÁTULAS DE AÇO



53589

12,00€

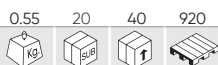

GRAMPEADOR INDUSTRIAL



ALTURA DOS GRAMOS: 4-14mm



52700

20,50€

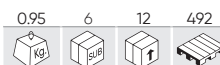

KIT DE ABOCARDADO DE TUBOS

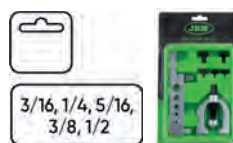

REF.	DESCRIÇÃO					€
14167	PACOTE DE GRAMPEADORES 1000 PÇS. PARA REF.53589 (11.3X0.7X8MM)	0.10	50	100	-	2,50€

51853

18,00€



KIT DE 5 LIMAS DE AÇO

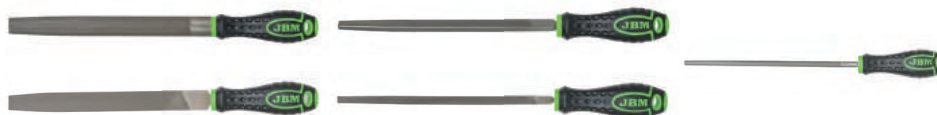

52760

4,10€



ESCOVAS METÁLICAS



52515

9,10€



ESCOVAS METÁLICAS



52905

28,00€



CURVA TUBOS 6-8-10MM



GRAUS MARCADOS

TUBOS EM ALUMÍNIO, COBRE E AÇO

MOBÍLIA DE OFICINA

- 72 CARROS DE FERRAMENTAS
- 83 CONJUNTOS DE FERRAMENTAS
- 90 ACESSÓRIOS
- 93 MESAS DE TRABALHO
- 95 ARMAZENAMENTO
- 99 BANCOS / ESTRADOS
- 100 TORNOS/BIGORNAS



54327

2.788,00€

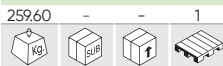

N

CONJUNTO DE MÓVEIS MODULARES PARA OFICINA (18 PCS)



ARMÁRIO MÓVEL COM 6 GAVETAS E SUPERFÍCIE DE BORRACHA

DIMENSÕES GERAIS

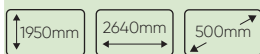

ACOPLAMENTO QUADRADO

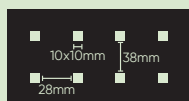

DIMENSÕES ESPECÍFICAS

	A	B	C	D	E	F	G
ALTURA	1890mm	340mm	340mm	38mm	900-950mm	750-880mm	900-950mm
COMPRIMENTO	600mm	680mm	680mm	2040mm	680mm	666mm	680mm
LARGURA	500mm	280mm	25mm	500mm	500mm	460mm	500mm

MEDIDAS INTERIOR

	A1	B1	E1	E2	E3	F1	F2	G1
ALTURA	1890mm	340mm	58mm	136mm	216mm	58mm	137mm	715mm
COMPRIMENTO	600mm	680mm	567mm	567mm	567mm	567mm	567mm	596mm
LARGURA	500mm	280mm	408mm	408mm	408mm	408mm	408mm	475mm

OS PAINÉIS DE FERRAMENTAS SÃO COMPATÍVEIS COM OS NOSSOS GANCHOS: REF.16354, 16355, 16356, 16357



EXPOSITOR SEM FERRAMENTAS

PEÇAS DE REPOSIÇÃO E ACESSÓRIOS

REF.	DESCRIÇÃO					€
16490	ARMÁRIO ALTO (REF. 54327)	56.20	-	1	-	650,00€
16491	ARMÁRIO DE CANTO 800X800X338 mm (REF. 54327)	22.00	-	1	-	307,00€
16492	ARMÁRIO DE CANTO COM CHAPA DE MDF (REF.54327)	59.40	-	1	-	675,00€
16493	ARMÁRIO COM 3 GAVETAS E SUPORTE PARA ROLO DE PAPEL (REF. 54327)	41.20	-	1	-	436,00€
16494	ARMÁRIO DE PAREDE (REF. 54327)	10.40	-	1	-	139,00€
16496	PLACA DE MDF 1360X500X38 MM (REF. 16627/16628/16500)	19.40	-	1	-	127,00€
16497	PLACA DE MDF 680X500X38MM (REF. 16627/16628/16500)	9.80	-	1	-	77,00€
16498	CONJUNTO DE 3 PEÇAS DE CAVILHAS PARA MADEIRA 680X338X25 mm (REF. 54327)	6.00	-	1	-	84,00€
16499	CONJUNTO DE 6 PEÇAS DE CAVILHAS PARA MADEIRA 775X338X25MM (REF.54327)	13.00	-	1	-	162,00€
16500	ARMÁRIO COM 2 PORTAS (REF. 54327)	33.60	-	1	-	463,00€
16516	CONJUNTO DE 4 PEÇAS DE CAVILHAS PARA ARMÁRIO DE CANTO (REF. 16492)	9.20	-	1	-	121,00€
16561	BARRA DE SUPORTE (REF.54327)	7.80	-	4	-	36,50€
16627	ARMÁRIO COM 4 GAVETAS (REF.54327)	43.50	-	1	-	225,00€
16628	ARMÁRIO DE 6 GAVETAS (REF.54327)	49.00	-	1	-	382,00€
16629	MESA DE TRABALHO MDF 2040X500X38MM (REF.54327)	27.80	-	1	-	419,00€
16600	PLACA DE AÇO INOXIDÁVEL 2040X500 MM (REF. 54327)	33.00	-	1	-	252,00€



MOBÍLIA DE OFICINA

CARRO DE 12 GAVETAS

53939 1.280,00€

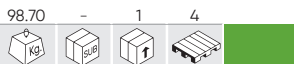

COM FERRAMENTAS

172 PCS

MEDIDAS INTERIOR 1A COLUNA

A GAVETAS MENINHAS (X4)



B GAVETA MEDIANA (X1)



C GAVETA GRANDE (X1)



DIMENSÕES GERAIS



53868 1.090,00€



VAZIO

172 PCS

MEDIDAS INTERIOR 2A COLUNA

D GAVETAS MENINHAS (X4)



E GAVETA MEDIANA (X1)



F GAVETA GRANDE (X1)



ACOPLAMENTO QUADRADO

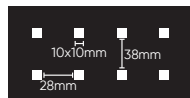

COM MÓDULOS EVA:

53708



325,00€

KIT DE 4 MÓDULOS DE CARBONO EVA PARA FERRAMENTAS

CONTÉM

REF.	Box	Box	Box	€
14296	6.05	4	80	118,00€
14297	3.30	4	96	87,00€
14298	2.10	4	96	51,50€
14299	3.25	4	96	87,00€

14296



REPOSIÇÕES DISPONÍVEIS



14297



REPOSIÇÕES DISPONÍVEIS



14298



REPOSIÇÕES DISPONÍVEIS



14299



REPOSIÇÕES DISPONÍVEIS



PARA MAIS INFORMAÇÕES

PÁGINA 83

CARRO 7 GAVETAS - XL

53912 1.280,00€

74.50 - - 4

COM FERRAMENTAS

199 PCS XL

53869 990,00€

74.50 - 1 4

VAZIO

199 PCS XL

53913 1.280,00€

74.50 - - 4

COM FERRAMENTAS

199 PCS XL

53870 990,00€

74.50 - 1 4

VAZIO

199 PCS XL



MEDIDAS INTERIOR

GAVETAS MENINHAS (X5)

74mm 705mm 400mm 25Kg

GAVETAS GRANDES (X2)

151,5mm 705mm 400mm 35Kg

ACOPLAMENTO QUADRADO

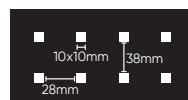

DIMENSÕES GERAIS

984mm 980mm 510mm



COM MÓDULOS EVA:

CONTÉM

REF.				€
14296	6.05	4	80	118,00€
14297	3.30	4	96	87,00€

REF.				€
14298	2.10	4	96	51,50€
14299	3.25	4	96	87,00€

REF.				€
15122	1.70	10	200	74,00€
15155	2.45	10	180	59,00€

REF.				€
15161	2.10	10	180	62,00€
15514	0.05	10	360	9,35€

14296

REPOSIÇÕES DISPONÍVEIS

15122

REPOSIÇÕES DISPONÍVEIS

14297

REPOSIÇÕES DISPONÍVEIS

15161

REPOSIÇÕES DISPONÍVEIS

14298

REPOSIÇÕES DISPONÍVEIS

15155

REPOSIÇÕES DISPONÍVEIS

14299

REPOSIÇÕES DISPONÍVEIS

15514

CARRO DE 7 GAVETAS - VERDE

172 PCS 300Kg

N

54389 790,00€

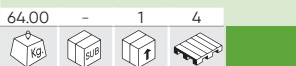

COM FERRAMENTAS

MEDIDAS INTERIOR

GAVETAS MENINHAS (X5)

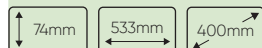

GAVETAS GRANDES (X2)



CAPACIDADE DE CARGA POR GAVETA: 35KG.
CAPACIDADE TOTAL DE CARGA: 300KG.

DIMENSÕES GERAIS

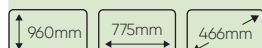

54503 490,00€



VAZIO

ACOPLAMENTO QUADRADO

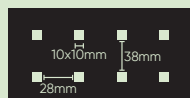

COM MÓDULOS EVA:

53708

325,00€

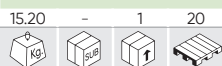

KIT DE 4 MÓDULOS DE CARBONO EVA PARA FERRAMENTAS

CONTÉM

REF.	Kg	sub	un	€
14296	6.05	4	80	118,00€
14297	3.30	4	96	87,00€
14298	2.10	4	96	51,50€
14299	3.25	4	96	87,00€

14296



REPOSIÇÕES DISPONÍVEIS



14297



REPOSIÇÕES DISPONÍVEIS



14298



REPOSIÇÕES DISPONÍVEIS



14299



REPOSIÇÕES DISPONÍVEIS



PARA MAIS INFORMAÇÕES

PÁGINA 83

CARRO DE 7 GAVETAS

53661 790,00€

65.50 - 1 4

COM FERRAMENTAS

53761 490,00€

52.50 - 1 4

VAZIO

53767 790,00€

56.00 - 1 4

COM FERRAMENTAS

53768 490,00€

56.00 - 1 4

VAZIO

53686 790,00€

65.00 - 1 4

COM FERRAMENTAS

53762 490,00€

55.50 - 1 4

VAZIO

53904 790,00€

65.00 - 1 4

COM FERRAMENTAS

54006 490,00€

55.00 - 1 4

VAZIO

MEDIDAS INTERIOR

GAVETAS MENINHAS (X5)



GAVETAS GRANDES (X2)



CAPACIDADE DE CARGA POR GAVETA: 30KG.
CAPACIDADE TOTAL DE CARGA: 70KG.

DIMENSÕES GERAIS



ACOPLAMENTO QUADRADO

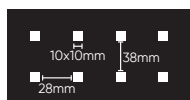

COM MÓDULOS EVA:

53708 325,00€

15.20 - 1 20

KIT DE 4 MÓDULOS DE CARBONO EVA PARA FERRAMENTAS

CONTÉM

REF.	Kg	Caixa	Paletes	€
14296	6.05	4	80	118,00€
14297	3.30	4	96	87,00€
14298	2.10	4	96	51,50€
14299	3.25	4	96	87,00€

14296



REPOSIÇÕES DISPONÍVEIS



14297



REPOSIÇÕES DISPONÍVEIS



14298



REPOSIÇÕES DISPONÍVEIS



14299



REPOSIÇÕES DISPONÍVEIS



PARA MAIS INFORMAÇÕES

PÁGINA 83

CARRINHO DE FERRAMENTAS COM 7 GAVETAS - ESPECIAL CAMINHÃO

54240 1.887,00€

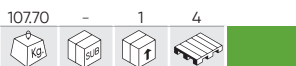

COM FERRAMENTAS

54237 1.887,00€

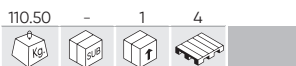

COM FERRAMENTAS

54238 1.887,00€

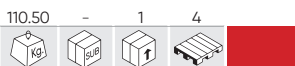

COM FERRAMENTAS

54239 1.887,00€



COM FERRAMENTAS

MEDIDAS INTERIOR

GAVETAS MENINHAS (X5)



GAVETAS GRANDES (X2)



CAPACIDADE DE CARGA POR GAVETA: 30KG.
CAPACIDADE TOTAL DE CARGA: 70KG.

DIMENSÕES GERAIS



ACOPLAMENTO QUADRADO

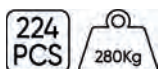
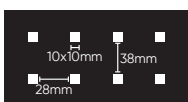

COM MÓDULOS EVA:



54134

1.415,00€

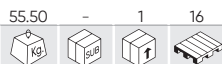

MÓDULO DE FERRAMENTAS DE REPARAÇÃO DE CAMIÕES

CONTÉM

REF.	Box	Box	Box	€
15730	10.22	2	48	289,00€
15731	5.20	2	48	214,00€

REF.	Box	Box	Box	€
15732	6.40	2	48	293,50€
15733	3.55	2	48	113,00€

REF.	Box	Box	Box	€
15734	9.40	2	48	288,50€
15735	10.00	2	48	152,00€

REF.	Box	Box	Box	€
15736	14.80	2	40	488,50€

15730

REPOSIÇÕES DISPONÍVEIS

15731

REPOSIÇÕES DISPONÍVEIS

15732

REPOSIÇÕES DISPONÍVEIS

15733

REPOSIÇÕES DISPONÍVEIS

15734

REPOSIÇÕES DISPONÍVEIS

15735

REPOSIÇÕES DISPONÍVEIS

15736

REPOSIÇÕES DISPONÍVEIS

PARA MAIS INFORMAÇÕES
PÁGINA 84

CARRO DE 7 GAVETAS - ESPECIAL VEÍCULOS ELÉTRICOS

54236 1.856,00€

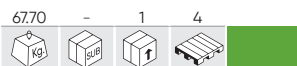

COM FERRAMENTAS

54233 1.856,00€

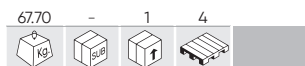

COM FERRAMENTAS

54234 1.856,00€



COM FERRAMENTAS

54235 1.856,00€

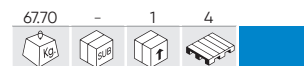

COM FERRAMENTAS

MEDIDAS INTERIOR

GAVETAS MENINHAS (X5)



GAVETAS GRANDES (X2)



CAPACIDADE DE CARGA POR GAVETA: 30KG.
CAPACIDADE TOTAL DE CARGA: 70KG.

DIMENSÕES GERAIS

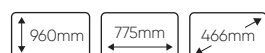

ACOPLAMENTO QUADRADO

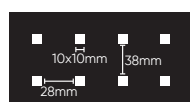

CONTÉM

REF.	DESCRIÇÃO	UNI.					€
52162	TERMÔMETRO LÁSER -50°C A 550°C	1	0.17	6	72	576	38,00€
53940	POSTE DE PLÁSTICO PARA CORRENTE - AMARELO / PRETO	4	0.55	-	6	90	13,20€
54326	CORRENTE DE PVC - 7M - AMARELO/PRETO	4	0.30	-	20	720	7,30€
53942	ELO DE FECHAR PRETO	8	0.01	50	5000	75000	0,50€
54093	MÓDULO EVA DE FERRAMENTA ISOLADA	1	3.25	-	4	80	441,00€
54114	MEDIDOR DE ISOLAMENTO	1	1.48	-	10	100	248,00€
54129	TAPETE ISOLANTE CLASSE 0	1	0.03	10	50	-	110,00€
54130	LUVAS ISOLANTES PARA TRABALHOS SOB TENSÃO T.9	1	0.35	-	1	100	58,00€
54132	PROTEÇÃO FACIAL ISOLANTE PARA TRABALHOS SOB TENSÃO	1	0.70	-	1	72	190,00€
54241	GANCHO DE RESGATE ISOLADO - 45KV	1	1.10	-	1	50	120,00€

PARA MAIS
INFORMAÇÕES
PÁGINA 345

CARRO COM 7 GAVETAS ESPECIAL KIT DE BLOQUEIO

53951 1.794,00€

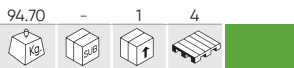

COM FERRAMENTAS

53952 1.794,00€

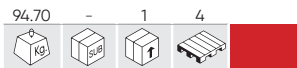

COM FERRAMENTAS

54501 1.794,00€

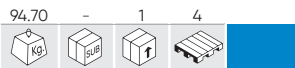

COM FERRAMENTAS

54502 1.794,00€

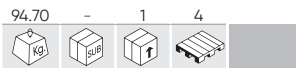

COM FERRAMENTAS

MEDIDAS INTERIOR

GAVETAS MENINHAS (X5)



GAVETAS GRANDES (X2)



CAPACIDADE DE CARGA POR GAVETA: 30KG.
CAPACIDADE TOTAL DE CARGA: 70KG.

DIMENSÕES GERAIS



ACOPLAMENTO QUADRADO

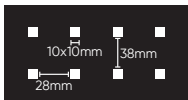

COM MÓDULOS EVA:

53775

1.109,00€

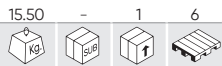

MÓDULO DE 6 FERRAMENTAS DE SINCRONIZAÇÃO DE MOTOR

CONTÉM

REF.	Kg	m³	Qtd	€
53769	5.90	3	36	178,00€
53770	6.15	3	36	198,00€

REF.	Kg	m³	Qtd	€
53771	4.05	3	36	158,00€
53772	6.40	3	36	229,00€

REF.	Kg	m³	Qtd	€
53773	6.60	3	36	298,00€
53774	6.95	3	36	190,00€

PARA MAIS INFORMAÇÕES
PÁGINA 297

53769



RENAULT / NISSAN / OPEL / VOLVO

53770



FORD / SEAT / VOLKSWAGEN / MAZDA / VOLVO

53771



FIAT / FORD / CITROËN / PEUGEOT

53772



FORD / VAG / MAZDA / VOLVO

53773



FIAT / ALFA / LANCIA / OPEL / SUZUKI / FORD

53774



OPEL / CHEVROLET / SAAB / FIAT / LANCIA / SUZUKI / FORD

54295

500,00€

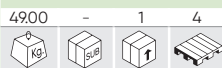

N

CARRINHO DE FERRAMENTAS COM 7 GAVETAS IGUAIS VERDE - VAZIO

DIMENSÕES GERAIS

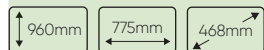

ACOPLAMENTO QUADRADO

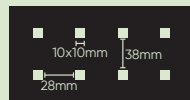

MEDIDAS INTERIOR



54296

520,00€



N

CARRINHO DE FERRAMENTAS COM 8 GAVETAS IGUAIS VERDE - VAZIO

DIMENSÕES GERAIS



ACOPLAMENTO QUADRADO

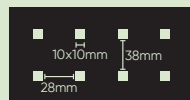

MEDIDAS INTERIOR



54297

540,00€

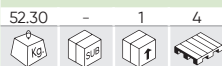

N

CARRINHO DE FERRAMENTAS COM 9 GAVETAS IGUAIS VERDE - VAZIO

DIMENSÕES GERAIS



ACOPLAMENTO QUADRADO

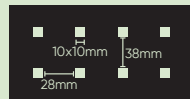

MEDIDAS INTERIOR



53672

440,00€

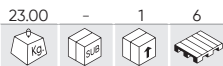

97 PCS

CARRINHO MODULAR



3 MÓDULOS INDEPENDENTES EQUIPADOS COM:



	1/2"	x11	8,10,11,12,13,14,16,17,19,21,22mm
	1/4"	x13	4,4.5,5,5.5,6,7,8,9,10,11,12,13,14mm
	1/2"	x1	
	1/4"	x1	
	1/2"	x2	125,300mm
	1/4"	x2	50,100mm
		x1	180mm
		x1	160mm
		x2	160mm, 180mm
		x2	PH2x125, PH1x100mm
		x2	6x150mm, 5x100mm
		x9	8,9,10,11,12,13,14,17,19mm
		x1	250mm
		x1	300g
		x1	250mm
		x1	200mm
		x8	1,5x8mm
		x1	3mm
	1/4"	x32	
	1/4"	x1	
	1/4"	x1	
	1/4"	x1	
	1/2"	x1	
	1/4"	x1	

A CAIXA DE FERRAMENTAS EM MÓDULOS EVA + BANDEJA SUPERIOR REMOVÍVEL



B 2 GAVETAS COM FERRAMENTAS EM MÓDULOS EVA



C COMPARTIMENTO DE ABERTURA FRONTAL



53867

1.095,00€

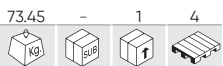

CARRINHO DE FERRAMENTAS COM 9 GAVETAS E SEPARADORES - VERDE

DIMENSÕES GERAIS

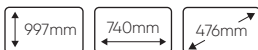

MEDIDAS INTERIOR



REF.	mm	UNI.			€
15073	174x53mm	21	0.05	200	1,00€
15076	396x53mm	18	0.30	50	3,50€

TAMBÉM PODE INTERESSAR...

REF.	mm			€
15070	67x53mm	0.05	200	0,50€
15071	103x53mm	0.05	200	0,60€
15072	138x53mm	0.05	200	0,70€
15074	210x53mm	0.10	200	1,00€
15075	280x53mm	0.10	200	1,20€



COM SEPARADORES ORGANIZAÇÃO LIVRE

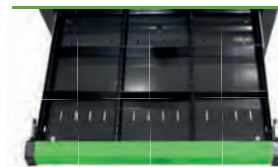

ACOPLAMENTO QUADRADO

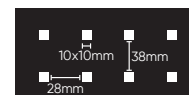



MÓDULOS EVA COM ACABAMENTO EM FIBRA DE CARBONO

53708 325,00€

15.20 - 1 20

KIT DE 4 MÓDULOS DE CARBONO EVA PARA FERRAMENTAS

CONTÉM

14296 118,00€

6.05 - 4 80

	1/2"	x17	x10, 11, 12, 13, 14, 15, 16, 17, 18, 19, 20, 21, 22, 24, 27, 30, 32mm
	1/4"	x13	4, 4.5, 5, 5.5, 6, 7, 8, 9, 10, 11, 12, 13, 14mm
	1/2"	x5	14, 15, 17, 19, 22mm
	1/4"	x8	6, 7, 8, 9, 10, 11, 12, 13mm
	1/2"	x8	E10, E11, E12, E14, E16, E18, E20, E24
	1/4"	x5	E4, E5, E6, E7, E8
	72	x2	1/2" - 1/4"
	1/2"	x2	125, 250mm
	1/4"	x2	50, 100mm
		x2	
	1/2"	x1	
	1/2"	x2	16, 21mm

	+	x2	PH1, PH2
	*	x2	PZ1, PZ2
	1/4"	x4	3, 4, 5, 6mm
		x3	SL4, SL5.5, SL6.5
		x8	T8, T10, T15, T20, T25, T27, T30
		x2	PH3, PH4
		x2	PZ3, PZ4
	8mm	x5	7, 8, 10, 12, 14mm
		x3	SL8, SL10, SL12
		x5	T40, T45, T50, T55, T60
		x1	1/4"
		x1	1/4"
	1/2"	x1	8mm
		x3	1.5, 2, 2.5mm

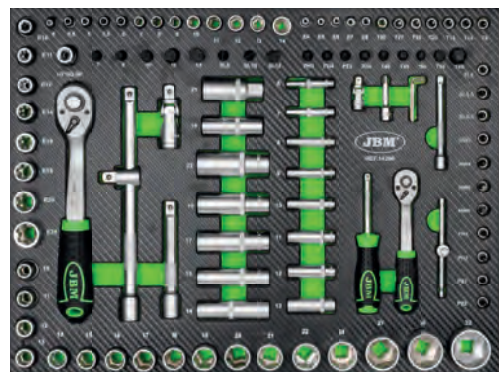

14297 87,00€

3.30 - 4 96

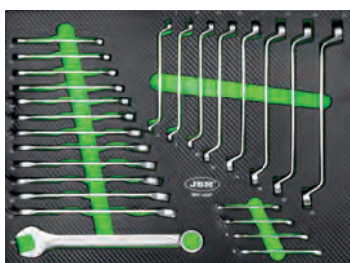

	6x7, 8x9, 10x11, 12x13, 14x15, 16x17, 18x19, 20x22mm
	6, 7, 8, 10, 11, 12, 13, 14, 15, 17, 19, 22mm

14298 51,50€

2.10 - 4 96



	+	PH0x75, PH1x100, PH2x100, PH3x150, PH4x200
	*	6, 7, 8, 10, 11, 12, 13, 14, 15, 17, 19, 22mm
		2x38mm
		6x38mm
		1.5, 2, 2.5, 3, 4, 5, 6, 8, 10mm
		10, 15, 20, 25, 27, 30, 40, 45, 50mm

14299 87,00€

3.25 - 4 96



	35mm		8"
	450g		10"
	10"		7.5"
	8"		3m
	8"		

54134

1.415,00€

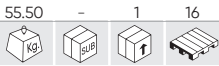

MÓDULO DE FERRAMENTAS DE REPARAÇÃO DE CAMIÕES

CONTÉM

15730

289,00€

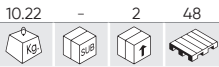

	55mm	H5, H6, H7, H8, H10, H12
	65mm	H14
	70mm	H16, H17, H18, H18, H20
	30mm	H4, H5, H6, H7, H8, H10, H12 T20, T25, T30, T40, T45, T50, T55
	75mm	H4, H5, H6, H7, H8, H10, H12 M5, M6, M8, M10, M12 T20, T25, T30, T40, T45, T50, T55
	1/2"	x9 E10, E11, E12, E14, E16, E18, E20, E22, E24
	1/2"	x10 10, 11, 12, 13, 14, 15, 16, 17, 18, 19mm

	1/2"	x3 50, 125, 250mm
	1/2"	x1 430mm
	1/2"	x1 10mm
	3/4"	x5 21, 24, 27, 34, 36mm
	3/4"	x4 24, 30, 32, 36 mm
		1/2x10, 3/8x10mm
		1/2x10, 3/8x10mm
	3/8"	10mm
	1/4"	300, 380, 450mm
	1/4"	
	1/2"	12

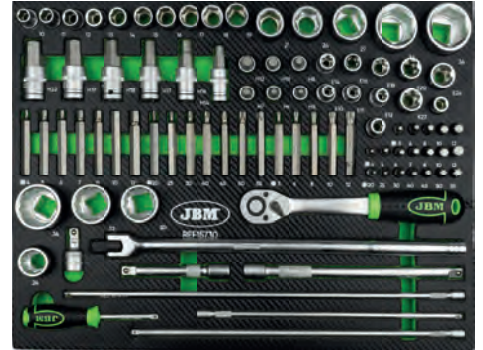

15731

214,00€

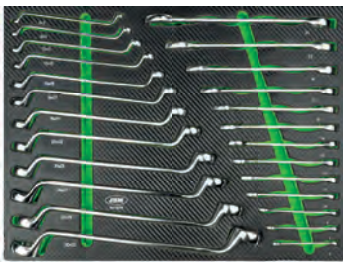
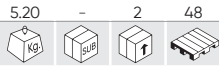

	6x7, 8x9, 10x11, 12x13, 14x15, 16x17, 18x19, 20x22, 21x23, 24x27, 25x28, 30x32mm
	6, 7, 8, 10, 11, 12, 13, 14, 15, 17, 19, 22, 24mm

15732

293,50€

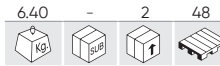

	10, 13, 17mm
	10x11, 12x13, 14x17mm
	E10xE12, E14xE18, E20xE24
	8x10, 11x13, 14x15, 16x17, 18x19mm
	27, 30, 32, 36mm
	10, 13, 17, 19mm

15733

113,00€

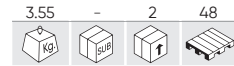

	PH0x75mmL, PH1x75mmL, PH2x100mmL, PH2x38mmL, PH3x150mmL, PH4x200mmL
	SL3.5x75mmL, SL5x75mmL, SL6x100mmL, SL6x38mmL, SL8x150mmL, SL9.5x200mmL
	10x11, 12x13, 14x15mm
	10x11, 12x13, 14x15, 16x17, 18x19mm

15734

288,50€



	1kg
	24, 27, 30, 32, 36, 41mm
	3/4" 500mm
	3/4" 500mm
	1.5, 2, 2.5, 3, 4, 5, 6, 8, 10mm

15735

152,00€



	220mm		250mm
	330mm		6" - 160mm
	330mm		7" - 180mm
	330mm		0°/45°/90°
	330mm		300mm

15736

488,50€

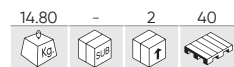

	1/2"	13, 14, 15, 16, 17, 18, 19, 21, 22, 24mm
	3/4"	78mm
	3/4"	22, 24, 27, 30, 32, 33, 36, 38, 46mm
	1/2"	51, 60mm
	1/2"	90mm
	1/2"	T40, T45, T50, T60, T70
	1/2"	78mm H6, H8, H14, H17
	3/4"	100mm T80, T90, T100
	1/2"	40mm M18
	1/2"(M)x3/4"(H)	- 3/4"(M)x1/2"(H)
	1/2"	- 3/4"
		125mm

15681

134,00€

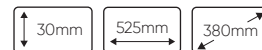
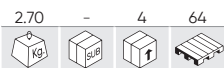

	H3, H4, H5, H6, H7, H8		7, 8, 10, 12, 14mm
	M8, M10, M12		PH3, PH4
	PH0, PH1, PH2, PH3		PZ3, PZ4
	PZ0, PZ1, PZ2, PZ3		8mm
	1/2" SL4, SL5.5, SL6.5, SL7		SL8, SL10, SL12
	T8, T9, T10, T15, T20, T25, T27, T30, T40		T40, T45, T50, T55, T60, T70
	T8, T9, T10, T15, T20, T25, T27, T30, T40		T40, T45, T50, T55, T60, T70
	TS10, TS15, TS20, TS25, TS27, TS30, TS40, TS45, TS50		H7 (230mmL), H10, H11, H13 (140mmL), H14, H17, H19, H22, H24 (55mmL)
	1/2" 8mm		M9 (100mmL), M10, M12, M14 (140mmL), M16 (53mmL), M16 (100mmL)
	3/8" 8mm		1/2" R7, R8 (240mmL), R9 (100mmL), R10 (140mmL)
	1/4" 6mm		T30 (300mmL), T40, T45, T50, T55, T60, T70 (140mmL), T80 (100mmL)
	1/2" M18		HT5 (160mmL)

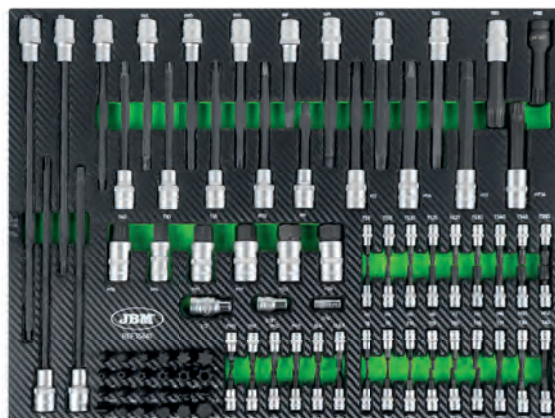

15122 74,00€

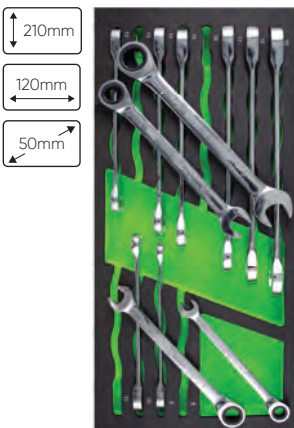
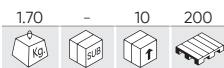

x12 8, 9, 10, 11, 12, 13, 14, 15, 16, 17, 18, 19mm

15155 59,00€

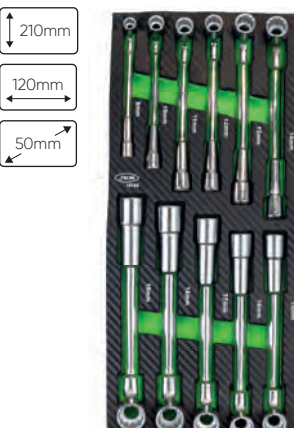
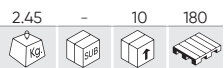

x11 8, 10, 11, 12, 13, 14, 15, 16, 17, 18, 19mm

15156 70,00€

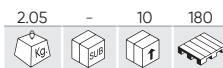

x4 21x23, 24x27, 25x28, 30x32mm

15157 42,00€

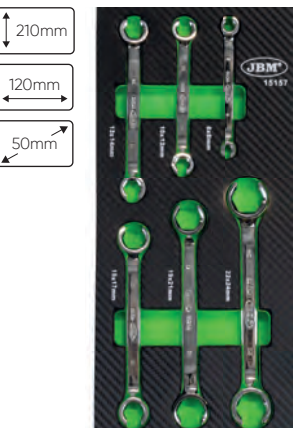
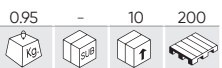

x7 6x8, 10x12, 13x14, 15x17, 19x21, 22x24mm

15158 59,00€

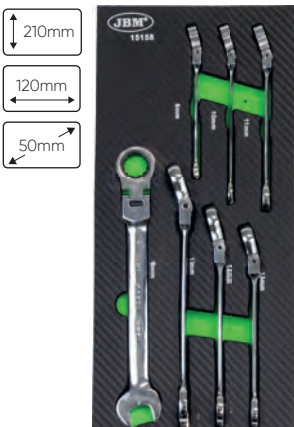

x7 8, 10, 11, 13, 14, 17, 19mm

15159 44,00€

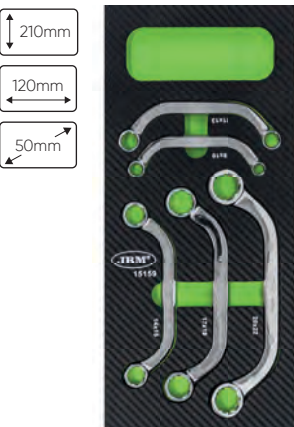

x5 8x10, 11x13, 14x15, 17x19, 20x22mm

15160 42,00€

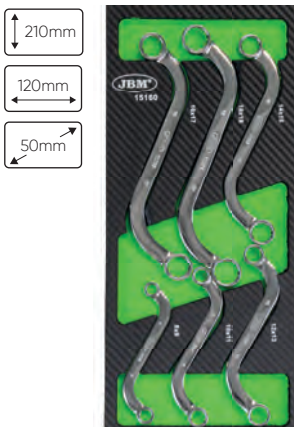
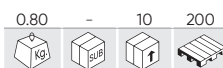

x6 8x9, 10x11, 12x13, 14x15, 16x17, 18x19mm

15161 62,00€

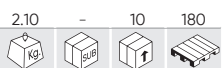

x4 27, 29, 30, 32mm

15316 58,00€

0.85 - 10 260

210mm
120mm
50mm

x3 8, 9, 10, 11, 12, 13, 14, 15, 16, 17, 18, 19mm

53943 21,50€

0.80 - 10 240

210mm
120mm
50mm

x7 PH4x200, PH3x150, PH2x100, PH2x38 PH1x80, PH0x120, PH1x100

53944 19,50€

0.80 - 10 240

210mm
120mm
50mm

x7 SL9x200, SL4x125, SL5x100, SL5x80, SL6x38, SL6x100, SL8x150mm

53945 18,90€

0.60 - 10 240

210mm
120mm
50mm

x7 T8x75, T9x75, T10x75, T15x75, T20x75, T25x100, T27x100

15454 35,40€

1.10 - 10 300

210mm
120mm
50mm

x1 8" x1 8"
x1 8" x1 8"

15541 27,60€

0.95 - 10 220

210mm
120mm
50mm

x1 7" - 180mm
x1 8" - 200mm
x1 8" - 200mm

15706 31,00€

0.55 - 10 240

210mm
120mm
50mm

x1 180 - 770mm x1 280 - 870mm
x1 130 - 640mm x1 170-580mm
x1 495mm

15737 45,00€

1.70 - 10 200

210mm
120mm
50mm

x1 6x180mm
x2 8x180, 10x180mm
x3 6x180, 8x180, 10x180mm
x3 2x160, 16x175, 19x180mm

15315 28,20€

1.05 - 10 260

210mm
120mm
50mm

x1 8" x1 8"
x1 8" x1 8"

15514 9,35€

0.05 - 10 360

210mm
120mm
50mm

VAZIO

54158 38,00€

1.70 - 10 200

210mm
120mm
50mm

3/8" x1 10mm
1/2" x1 10mm
30mm x7 4, 5, 6, 7, 8, 10, 12mm
75mm x7 4, 5, 6, 7, 8, 10, 12mm
30mm x8 T20, T25, T30, T40, T45, T50, T55, T60
75mm x8 T20, T25, T30, T40, T45, T50, T55, T60
30mm x5 M5, M6, M8, M10, M12
15mm x5 M5, M6, M8, M10, M12

54158 38,00€

1.70 - 10 200

210mm
120mm
50mm

3/8" x1 10mm
1/2" x1 10mm
30mm x7 4, 5, 6, 7, 8, 10, 12mm
75mm x7 4, 5, 6, 7, 8, 10, 12mm
30mm x8 T20, T25, T30, T40, T45, T50, T55, T60
75mm x8 T20, T25, T30, T40, T45, T50, T55, T60
30mm x5 M5, M6, M8, M10, M12
15mm x5 M5, M6, M8, M10, M12

15162 30,20€

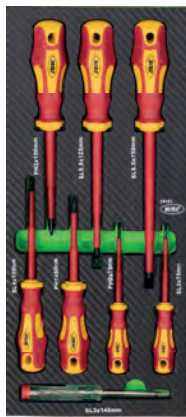
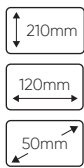
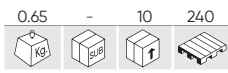

- ⊖ **x4** SL3x75, SL4x100, SL5.5x125, SL6.5x150mm
- ⊕ **x3** PH0x75, PH1x80, PH2x100mm
- ⌵ **x1** 140mm

54093

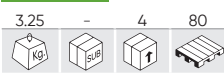

- ⊖ **x10** 3/8" 45mm 8, 10, 11, 12, 13, 14, 16, 17, 18, 19, 21, 22mm
- ⊖ **x2** 4x100, 5,5x125mmL
- ⊕ **x2** PH1x80, PH2x100mm
- ⌵ **x1** 185mm
- ⌵ **x1** 52mm
- ⌵ **x1** 185mm
- ⌵ **x6** 7x86, 8x99, 10x109, 12x127, 14x141, 17x156mm
- ⌵ **x1** 1/2" 125mm
- ⌵ **x1** 3/8" 200mm
- ⌵ **x1** 3/8" 200mm

15799 28,30€

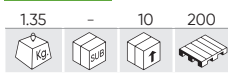

- ⌵ **x1** 450g
- ⌵ **x1** 35mm

16111 19,20€

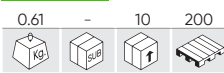

- ⌵ **x1** 220mm
- ⌵ BV1.25
- ⌵ BV2
- ⌵ RV2-4
- ⌵ RV2-4L
- ⌵ SV2-4
- ⌵ SV5.5-6
- ⌵ MDD2-250
- ⌵ FDD2-250

51805 17,00€

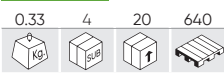

- ⌵ **x5** 50, 75, 100, 152, 227mm

51447 16,00€

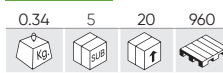

- ⌵ **x5** 50, 75, 100, 152, 227mm

51448 52,00€

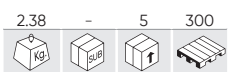

- ⌵ **x5** 50, 125, 250, 380, 510mm

52912 91,00€

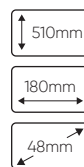
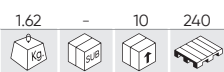

- x6** E6xE7 (200mmL), E8xE10 (235mmL), E11xE12 (290mmL), E14xE16 (370mmL), E18xE20 (410mmL), E22xE24 (420mmL)

54066 83,00€

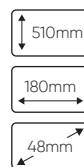
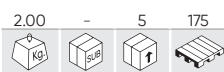

- x7** 8mm (23,5mmL), 10mm (29,3mmL), 12mm (32,8mmL), 13mm (34,9mmL), 14mm (36,7mmL), 17mm (41mmL), 19mm (42mmL)

51864 64,00€

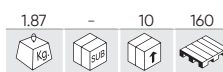

- x6** 10x11mm (290mmL), 12x14mm (330mmL), 13x15mm (368mmL), 16x18mm (407mmL), 17x19mm (407mmL), 22x24mm (430mmL)

MOBÍLIA DE OFICINA

54032 84,00€

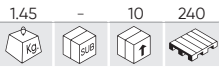

400mm
180mm
50mm



x12 8mm (89mmL), 9mm (94mmL), 10mm (95mmL), 11mm (99mmL), 12mm (102mmL), 13mm (107mmL), 14mm (114mmL), 15mm (117mmL), 16mm (123mmL), 17mm (125mmL), 18mm (130mmL), 19mm (135mmL)

15083 8,50€

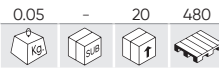

380mm
175mm
50mm



VAZIO

15084 68,00€

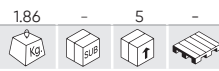

380mm
175mm
50mm

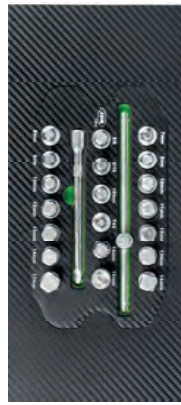

x2 5/16", 3/8"
x7 7, 8, 10, 11, 12, 13, 14mm
x1 10mm
x1 10mm
x7 8, 9, 10, 12, 13, 14, 17mm
x1 T45
x1 M16
x1 200mm
x1 150mm

53979 34,60€

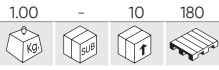

390mm
340mm
50mm

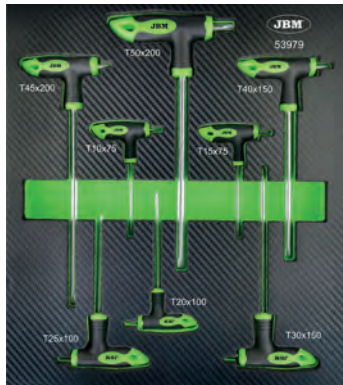

x8 T10x75, T15x75, T20x100, T25x100, T30x150, T40x150, T45x200, T50x200mm

53980 34,60€

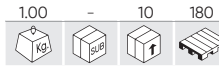

390mm
340mm
50mm



x8 H2x100, H2.5x100, H3x100, H4x150, H5x150, H6x200, H8x200, H10x200

MÓDULOS EVA

11996 48,00€

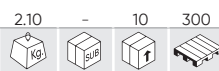

390mm
175mm
50mm



x10 6x7, 8x9, 10x11, 12x13, 14x15, 16x17, 18x19, 20x22, 24x27, 30x32mm

11997 39,00€

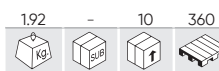

390mm
175mm
50mm



x8 6x7, 8x9, 10x11, 12x13, 14x15, 16x17, 18x19, 20x22mm

11998 49,00€

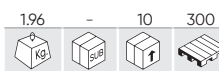

390mm
175mm
50mm



x17 6, 7, 8, 9, 10, 11, 12, 13, 14, 15, 16, 17, 18, 19, 20, 21, 22mm

13668 18,70€

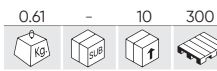

390mm
175mm
50mm



x1 3m
x1 230mm
x1 50mm
x1 250mm

11994 33,00€

0.68 - 10 233
Kg SUB f

390mm
175mm
50mm



- x1 1/4" 250mm
- x1 1/4" 125mm
- x1 1/4"
- x13 4, 4.5, 5, 5.5, 6, 7, 8, 9, 10, 11, 12, 13, 14mm

14114 19,30€

0.93 - 10 360
Kg SUB f

390mm
175mm
50mm



- x1 10°
- x1 10°

13667 17,60€

0.83 - 10 360
Kg SUB f

390mm
175mm
50mm



- x1 253mm
- 2x6, 3x7, 3x9, 6x10mm

13923 7,45€

0.05 - 30 1299
Kg SUB f

390mm
175mm
50mm

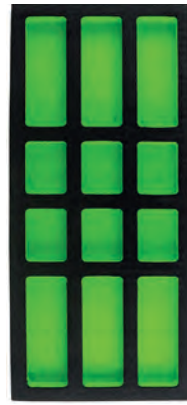

- VAZIO

53671 41,00€

0.85 - 10 520
Kg SUB f

210mm
120mm
50mm



- x3 1/4" - 85 mm
- 1/2" - 135 mm
- 3/8" - 102 mm

53620 88,00€

3.52 - 4 112
Kg SUB f

30mm 525mm 380mm



- x17 6, 7, 8, 9, 10, 11, 12, 13, 14, 15, 16, 17, 18, 19, 20, 21, 22mm
- x8 6x7, 8x9, 10x11, 12x13, 14x15, 16x17, 18x19, 20x22mm

MÓDULOS DE PLÁSTICO

10732 18,70€

0.70 - 10 220
Kg SUB f

390mm
175mm
50mm



- x1 3m
- x1 230mm
- x1 50mm
- x1 250mm

10735 20,30€

0.98 - 10 300
Kg SUB f

390mm
175mm
50mm



- x1 8°
- x1 8°
- x1 8°
- x1 8°

PAINEL PARA FERRAMENTAS

REF.	mm	Kg	SUB	f		€
52419	A 1000x600mm	7.07	-	1	30	80,00€
52420	B 1500x600mm	10.80	-	2	35	108,00€
52421	C 2000x600mm	14.00	-	1	38	172,00€

ACOPLAMENTO QUADRADO

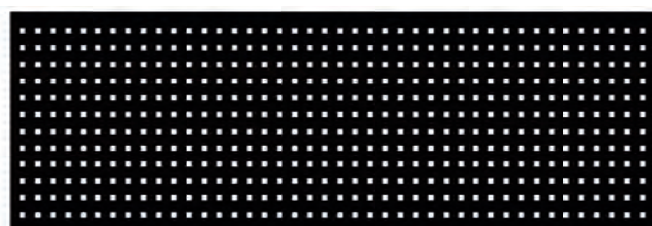

ACESSÓRIOS PARA ARMARIOS

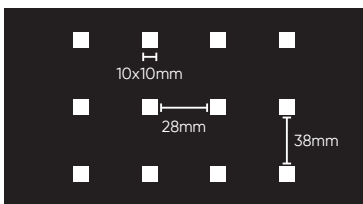

15068 15,20€

0.65	-	25	500
------	---	----	-----



15069 32,80€

1.65	-	1	80
------	---	---	----



15313 14,00€

0.60	-	1	340
------	---	---	-----



14354 14,00€

0.60	-	1	184
------	---	---	-----



16359 10,00€

0.20	1	30	-
------	---	----	---

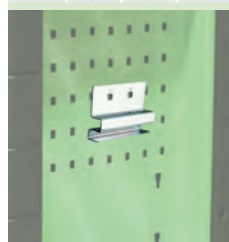

16361 16,50€

0.60	1	30	280
------	---	----	-----

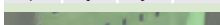

16362 20,00€

2.00	1	30	-
------	---	----	---

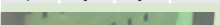

16363 14,50€

0.40	1	30	-
------	---	----	---



16344 43,00€

2.00	-	4	72
------	---	---	----

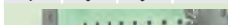

16358 12,00€

0.45	1	30	-
------	---	----	---



16360 12,00€

0.38	1	30	15
------	---	----	----

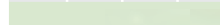

16354 1,50€

0.50	10	100	-
------	----	-----	---

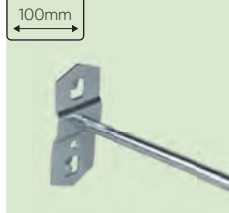

16355 2,00€

0.10	10	100	-
------	----	-----	---

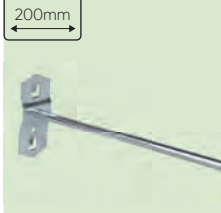

16356 2,50€

0.01	10	100	-
------	----	-----	---

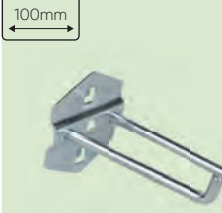

16357 2,50€

0.10	10	100	-
------	----	-----	---

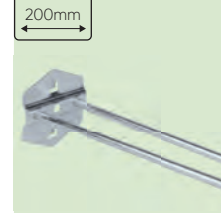
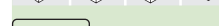

ACESSÓRIOS PARA ARMARIOS

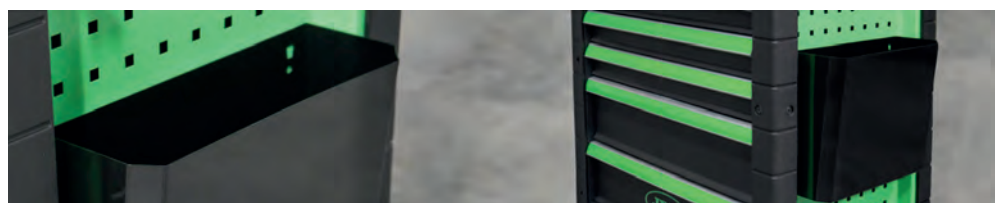
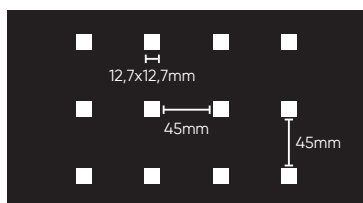

16161 17,50€

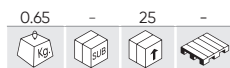

16162 35,10€

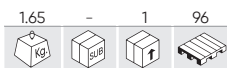

16163 10,20€

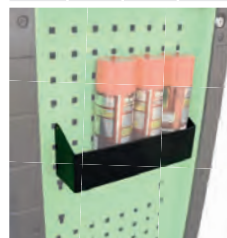

16188 39,60€

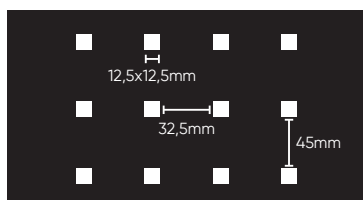

51655 4,10€



51976 1,63€



51658 4,50€



51422 2,97€



52634 5,25€



51975 2,27€



51419 2,79€



51656 3,65€



51654 4,80€



52635 4,80€

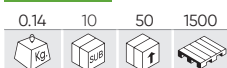

51657 5,85€



51653 5,10€



PEÇAS DE REPOSIÇÃO

REF.	DESCRIÇÃO					€
14578	CONJUNTO DE 2 GRANDES INSERTOS DE ROLAMENTO DE ROLAMENTOS DE ESFERA PARA 53661, 53686, 53904, 54006	1.05	-	25	-	12,50€
14580	TAMPA SUPERIOR PARA REF. 53661 - 53686 - 53904 - 54006 - 54389	2.60	-	3	39	41,00€
14783	PROTECTOR DIREITO PARA REF. 53686, 53661, 53904, 54006, 54389	0.25	-	50	-	5,50€
15023	RODA FIXA PARA NO. 53765, 53766, 53870	0.65	-	10	-	12,50€
15024	VOLANTE PARA NO. 53765, 53766, 53870	0.95	-	8	-	15,00€
15025	RODA FIXA PARA NO. 53900, 53901	0.65	-	10	-	12,50€
15026	VOLANTE PARA NO. 53900, 53901	0.95	-	8	-	15,00€
15030	ALÇA PARA NO. 53765, 53766	0.30	-	50	-	8,00€
15033	ALÇA ESTREITA PARA NO. 53868	0.14	-	50	-	6,00€
15034	TAMPA SUPERIOR PARA NO. 53868	2.00	-	2	-	57,00€
15035	ALÇA PARA NO. 53869	0.36	-	20	-	8,50€
15036	ALÇA PARA NO. 53870	0.36	-	20	-	8,50€
15037	ALÇA PARA NO. 53900, 53901	0.10	-	-	-	8,00€
15038	TAMPA SUPERIOR PARA NO. 53869, 53870	2.00	-	2	-	34,50€
15040	RODA FIXA PARA NO. 53904, 54006, 54389	0.66	-	10	-	12,50€
15041	VOLANTE PARA NO. 53904, 54006, 54389	0.98	-	8	-	15,00€
15042	ALÇA PARA NO. 53904, 54006	0.10	-	1	-	7,50€
15050	ALÇA PARA NO. 53661, 53686	0.10	-	50	-	9,50€
15058	PROTEÇÃO LATERAL PARA NO. 53868	0.36	-	-	-	7,50€
15065	PROTEÇÃO LATERAL PARA NO. 53869, 53870	0.28	-	12	-	6,50€
16387	ALÇA PARA NO. 54389	0.40	-	-	-	10,50€



CADEADOS

CURTO

REF.	DESCRIÇÃO					€
53403	38mm	0.15	8	96	3168	6,50€
53405	32mm	0.10	8	96	3168	5,30€
53406	50mm	0.30	8	48	1728	8,55€
53407	63mm	0.35	8	48	3168	12,70€
53408	75mm	0.48	3	24	840	19,30€

LONGO

REF.	DESCRIÇÃO					€
53404	38mm	0.15	8	96	3168	6,50€
53409	50mm	0.30	8	48	3168	9,00€



CADEADOS RESISTENTES À ÁGUA

REF.	DESCRIÇÃO					€
53399	30mm	0.90	8	48	3168	3,50€
53400	40mm	0.20	8	48	499	5,70€
53401	50mm	0.35	8	48	499	7,40€
53402	65mm	0.05	10	40	499	9,60€



54388

366,00€

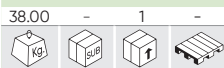

CARRINHO PARA DIAGNÓSTICO

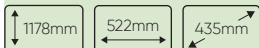

Carrinho de oficina multifunções com quatro tabuleiros e um compartimento fechado. Adequado para o uso de computadores portáteis, aparelhos de teste e carregadores de bateria.

Tem duas pegas e rodas rotativas que facilitam o transporte com muito conforto. Inclui também um painel perfurado, um suporte para rolos de papel e dois tabuleiros laterais para guardar ferramentas.

MEDIDAS DA PRATELEIRA SUPERIOR	433x398mm
MEDIDAS DO PAINEL PERFURADO	430x475mm
TOTAL DE PRATELEIRAS	4
CAPACIDADE DA PRATELEIRA SUPERIOR	20Kg
DIÂMETRO DA RODA	101mm
RODAS COM TRAVÕES	2



N

REF. DESCRIÇÃO

REF.	DESCRIÇÃO	KG	QTD	€
16481	ROUE AVEC FREIN POUR REF. 54388	11.60	20	14,00€
16482	RODA PARA REF. 50818	2.80	20	13,50€

51576

125,00€

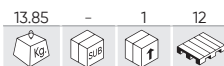

CARRO COM 3 BANDEJAS



52373

252,00€

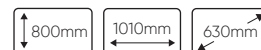

CARRO COM 3 BANDEJAS MAXI



51738

850,00€

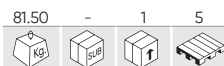

MESA DE TRABALHO COM 3 GAVETAS

DIMENSÕES GERAIS



MEDIDAS GAVETA INTERIOR

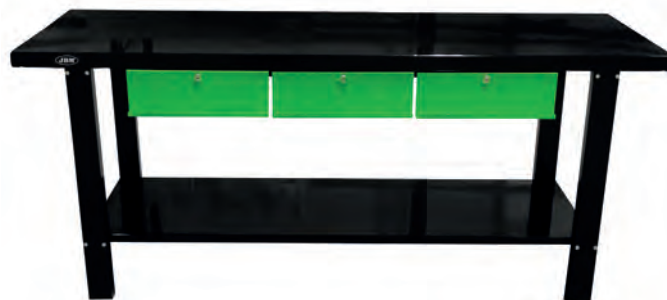
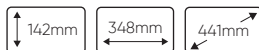

REF. DESCRIÇÃO

REF.	DESCRIÇÃO	KG	QTD	€
15144	TAPETE DE BORRACHA PARA MESA DE TRABALHO, NO. 51738	2.50	100	30,00€

51737

699,00€

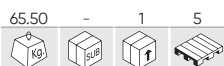

MESA DE TRABALHO COM 2 GAVETAS



DIMENSÕES GERAIS



MEDIDAS GAVETA INTERIOR



REF. DESCRIÇÃO

REF.	DESCRIÇÃO	KG	SAB	Q	AS	€
15145	CONJUNTO DE 2 TAPETES DE BORRACHA PARA MESA DE TRABALHO, NO. 51737	1,90	-	100	100	20,45€

53674

447,00€



MESA DE TRABALHO COM 1 GAVETA



DIMENSÕES GERAIS



MEDIDAS GAVETA INTERIOR



REF. DESCRIÇÃO

REF.	DESCRIÇÃO	KG	SAB	Q	AS	€
15146	MAT DE BORRACHA PARA MESA DE TRABALHO, NO. 53674	1,35	-	100	100	16,20€

51035

799,00€



MESA DE TRABALHO COM PAINEL FRONTAL



DIMENSÕES GERAIS



ACOPLAMENTO QUADRADO

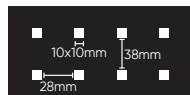

MEDIDAS GAVETA INTERIOR

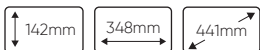

54328

199,00€



BANCADA DE TRABALHO DOBRÁVEL COM PAINEL TRASEIRO



N

DIMENSÕES GERAIS

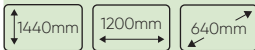

ACOPLAMENTO QUADRADO

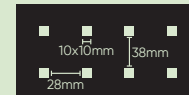

DIMENSÕES FEIXADO

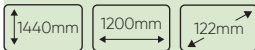

SUPERFÍCIE DE TRABALHO



EXPOSITOR SEM FERRAMENTAS

50957

22,00€

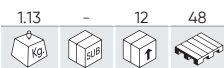

CAIXA 24+2 COMPARTIMENTOS



- 24 compartimentos de 8x5,5 cm.
- 2 compartimentos de 15x7,5 cm.
- Abatível de 26 a 5 separações.

50959

14,00€

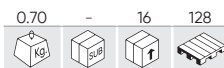

CAIXA 20+1 COMPARTIMENTOS



- 20 compartimentos de 6x7 cm.
- 1 compartiment de 35x7 cm.
- Abatível 19 a 4 separações.

51051

34,80€

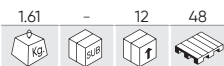

ORGANIZADOR DE 5 COMPARTIMENTOS



CAIXAS
INSEPARÁVEIS

51050

285,00€

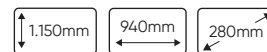
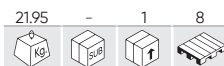

ESTANTERIA COM 47 COMPARTIMENTOS

COMPARTIMENTOS GRANDES

Total: 15
Medidas: 24x14,5x13 cm
Medidas da estanteria: 84x14x24 cm
Total estantes: 3

COMPARTIMENTOS PEQUENOS

Total: 32
Medidas: 16x10x7,5 cm
Medidas da estanteria: 84x16x8 cm
Total estantes: 4



51574

52,00€

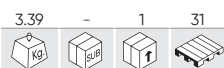

CAIXA DE FERRAMENTAS COM 5 COMPARTIMENTOS



DIMENSÕES GERAIS

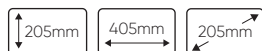

ABERTO



CAIXA DE FERRAMENTAS

REF.						€
54393	750x200x220mm - 9Kg	7.70	-	1	15	92,00€
54394	530x200x220mm - 5,2Kg	5.70	-	1	22	64,00€
54395	450x200x220mm - 4,5Kg	6.20	-	1	24	53,00€



51575

317,00€

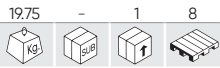

CAIXA DE FERRAMENTAS COM 6 GAVETAS

DIMENSÕES GERAIS



GAVETAS MENINHAS (X3)

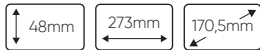

GAVETA MEDIANA (X2)



GAVETA GRANDE (X1)

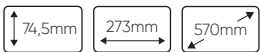

51600

109,00€

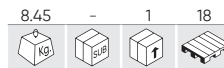

CAIXA DE FERRAMENTAS COM 3 GAVETAS FRONTAIS

DIMENSÕES GERAIS



MEDIDAS GAVETA INTERIOR

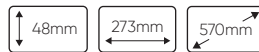

53782

14,00€

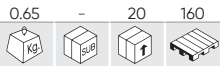

BOLSA PARA FERRAMENTAS ELÉTRICAS - GRANDE



53253

98,00€

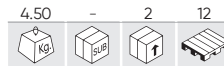

MALA DE FERRAMENTAS

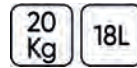

54080

53,50€

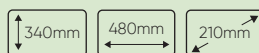

N

BOLSA DE FERRAMENTAS

20L



54374

75,50€



N

SACO DE FERRAMENTAS

15 Kg





BOLSA PARA FERRAMENTAS

REF.	DESCRIÇÃO					€
53702	BOLSA PARA FERRAMENTAS ELÉTRICAS - PEQUENA	1.00	-	5	180	28,50€
53703	MOCHILA PARA FERRAMENTAS ELÉTRICAS - MÉDIA	1.40	-	5	120	41,00€
53704	MOCHILA PARA FERRAMENTAS ELÉTRICAS - GRANDE	1.65	-	5	120	42,00€

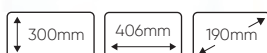

53903

59,00€



CONJUNTO DE 3 BANDEJAS DE FERRAMENTAS ELÁSTICAS ANTI DERRAPANTE

3 PCS



REF.	DESCRIÇÃO					€
15010	285x137x27mm	0.40	-	20	360	16,50€
15011	285x202x27mm	0.45	-	20	320	18,00€
15012	543x300x27mm	1.05	-	10	120	31,50€

RECIPIENTE MAGNÉTICO FLEXÍVEL

REF.	Ø SUPERIOR	Ø BASE	MEDIDAS IMPLEMENTADAS	MEDIDAS DOBRÁVEIS					€
52516	225mm	88mm	135mm	43mm	0.42	6	24	1152	28,00€
52517	135mm	53mm	90mm	31mm	0.10	12	72	1152	6,00€



50787 8,00€

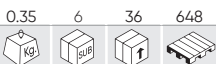

PRATO REDONDO MAGNÉTICO Ø150MM



50788 14,50€



PRATO RECTÂNGULAR MAGNÉTICO



52466 11,00€

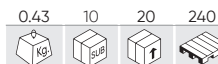

RECIPIENTE MAGNÉTICO

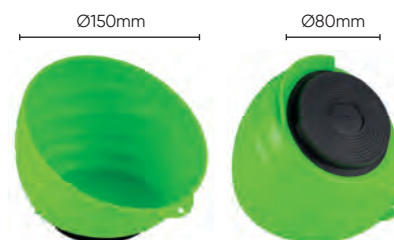

53958 6,50€

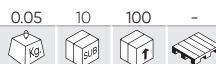

CONJUNTO DE 5 ÍMÃS



50789 29,00€

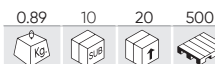

BARRA MAGNÉTICA PARA FERRAMENTAS



53192 52,00€

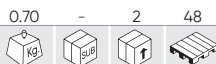

ESTRADO EM ESPUMA



DIMENSÕES GERAIS



MEDIDAS DOBRADO



- DE ESPUMA EVA.

53191 14,80€



ESTRADO EM ESPUMA



DIMENSÕES GERAIS



- DE ESPUMA EVA.

50843

79,00€

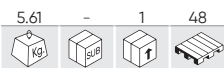

BANCO HIDRÁULICO



Ø 295mm

Ø 380mm



50844

65,00€

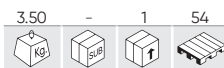

BANCO DE AÇO



DIMENSÕES GERAIS



52148

65,00€

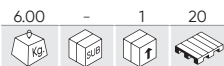

ESTRADO MECÂNICO PLÁSTICO



DIMENSÕES GERAIS



50808

77,00€

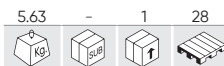

ESTRADO DE MECÂNICO ALMOFADADO DOBRÁVEL



DIMENSÕES GERAIS



REF. DESCRIÇÃO

11971 RODAS PARA REF. 52148

REF.	DESCRIÇÃO	Box	Unit	Pallet	€
11971	RODAS PARA REF. 52148	0.20	5	50	3,60€

53211

75,00€

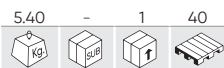

ESTRADO MECÂNICO ALMOFADADO DOBRÁVEL



DIMENSÕES GERAIS



MEDIDAS DOBRADO



52542

109,00€

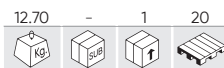

ESTRADO MECÂNICO ALMOFADADOS DOBRÁVEL



DIMENSÕES GERAIS



MEDIDAS DOBRADO

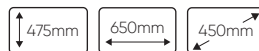

MOBÍLIA DE OFICINA

52869

52,00€

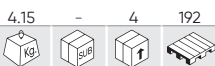

TORNO DE BANCADA 100MM



52870

100,00€

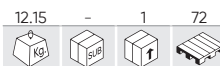

TORNO DE BANCADA 150MM



53031

59,00€

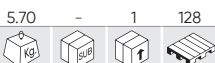

TORNO DE BANCADA BASE ROTATIVA 4"



53032

126,00€

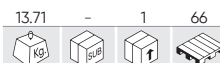

TORNO DE BANCADA BASE ROTATIVA 6"



52871

258,00€

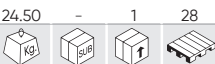

TORNO DE BANCADA ABERTURA RÁPIDA
BASE ROTATIVA



ABERTURA INMEDIATA
+ PARAFUSO ROTATIVO

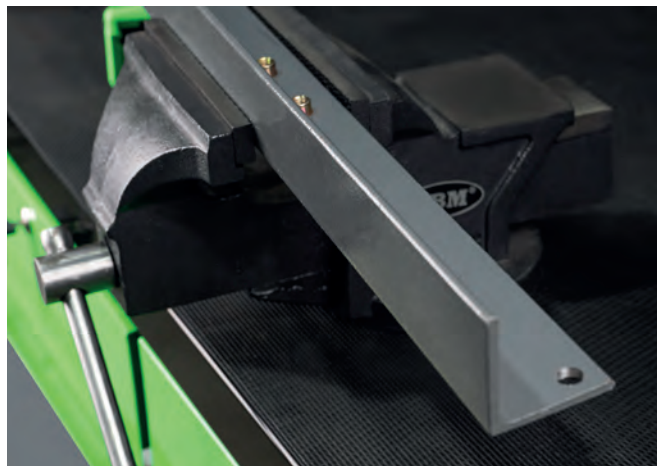

BIGORNAS PROFISSIONAIS

REF.	Kg.	mm						€
52308	50Kg	190x625x140mm	47.00	-	1	24	440,00€	
52309	100Kg	245x790x180mm	100.00	-	1	8	941,00€	

AÇO



FERRAMENTAS ELÉTRICAS SEM FIO

- 102 APARAFUSAR
- 106 PERFURAR
- 108 LIXAR/POLIR
- 110 SERRAR
- 113 FERRAMENTAS ESPECIAIS
- 118 FERRAMENTAS ELÉTRICAS DE JARDINAGEM
- 122 BATERIAS / CARREGADORES
- 123 ACESSÓRIOS / CONSUMÍVEIS



**USE-OS COM BATERIAS JBM:
UMA ÚNICA BATERIA ADEQUADA PARA TODAS AS FERRAMENTAS**

TRÊS TIPOS DE BATERIA E DOIS TIPOS DE CARREGADOR.
ESCOLHA O QUE VOCÊ PREFERIR!



60046C

339,00€

5,00 - 4 40



N

CHAVE DE IMPACTO SEM FIO 1/2" 550NM COM ESTOJO

CONTÉM

REF.	DESCRIÇÃO					€
60013	4.0 AH BATERIA DE LITIO	0.75	-	5	700	80,00€
60016	CARREGADOR 20V - 4A	0.80	-	5	210	49,00€
60046	CHAVE DE IMPACTO SEM ESCOVAS A BATERIA 1/2" 550NM	1.50	-	4	200	174,00€

Essa ferramenta foi projetada para atarraxar e desatarraxar porcas e parafusos que exijam um torque elevado.

Equipada com um LED de trabalho e um seletor de sentido de rotação que também permite travar o gatilho e evitar o acionamento acidental da ferramenta.

Tem 5 engrenagens diferentes, 3 para atarraxar e 2 para desatarraxar, que permitem ajustar a velocidade de acordo com a operação desejada. Além disso, graças ao cabo ergonômico, proporciona melhor empunhadura e precisão.

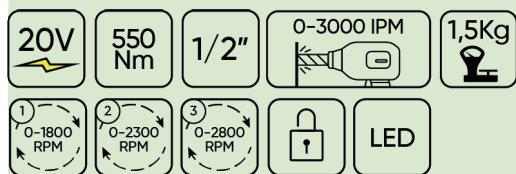

MOTOR BRUSHLESS

ILUMINAÇÃO DE FUNDO LED

INTERRUPTOR DO SENTIDO DE ROTAÇÃO PARA FRENTE/TRÁS

ALÇA ERGONÔMICA

5 ENGRENAGENS DIFERENTES

GANCHO PARA CINTO

OS COMPARTIMENTOS NAS NOSSAS CAIXAS SÃO COMPATÍVEIS COM BATERIAS DE 4.0AH E 6.0AH.



60046

174,00€

1,50 - 4 200



N

CHAVE DE IMPACTO SEM ESCOVAS A BATERIA 1/2" 550NM

BATERIA NÃO INCLUÍDA.



**USE-OS COM BATERIAS JBM:
UMA ÚNICA BATERIA ADEQUADA PARA TODAS AS FERRAMENTAS**

TRÊS TIPOS DE BATERIA E DOIS TIPOS DE CARREGADOR.
ESCOLHA O QUE VOCÊ PREFERIR!



60044C

485,00€



CHAVE DE IMPACTO SEM FIO 1/2" 1300NM COM ESTOJO

CONTÉM

REF.	DESCRIÇÃO					€
60013	4.0 AH BATERIA DE LITIO	0.75	-	5	700	80,00€
60016	CARREGADOR 20V - 4A	0.80	-	5	210	49,00€
60044	CHAVE DE IMPACTO COM MOTOR BRUSHLESS 1/2" 1300NM	3.25	-	5	90	330,00€

Esta ferramenta foi projetada para tensionar e afrouxar parafusos e porcas que exigem um alto torque. Equipada com um motor brushless X-TorQ de nova geração, que permite desparafusar parafusos e porcas presas ou muito apertadas até 2 vezes mais rápido. Robusta e durável, com carcaça de alumínio protegida com elastômero na parte frontal.

Vem equipada com uma luz de trabalho em LED e um seletor de sentido de rotação que também permite bloquear o gatilho e evitar um acionamento acidental da ferramenta. Possui 5 marchas diferentes, 3 para apertar e 2 para afrouxar, permitindo ajustar a velocidade conforme a operação a ser realizada. Seu duplo martelo de novo design proporciona mais IPM e menos vibração.

Novo anel de fixação de soquete: troca de soquetes mais rápida e fixação mais segura. Equilíbrio e peso perfeitos para trabalhos que exigem soquetes de grandes dimensões e altos níveis de torque. Gancho de grande tamanho útil para pendurar a máquina em estruturas metálicas ou no cinto de trabalho. Além disso, graças à sua empunhadura

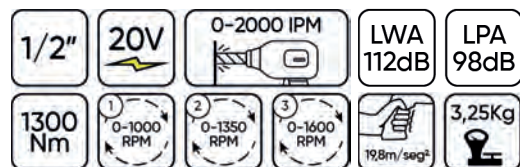

- MOTOR BRUSHLESS
- ILUMINAÇÃO DE FUNDO LED
- INTERRUPTOR DO SENTIDO DE ROTAÇÃO PARA FRENTE/TRÁS
- ALÇA ERGONÔMICA
- 5 ENGRENAGENS DIFERENTES
- GANCHO PARA CINTO

OS COMPARTIMENTOS NAS NOSSAS CAIXAS SÃO COMPATÍVEIS COM BATERIAS DE 4.0AH E 6.0AH.

60044

330,00€



CHAVE DE IMPACTO COM MOTOR BRUSHLESS 1/2" 1300NM

BATERIA NÃO INCLUÍDA.



60048C

560,00€

715	-	4	32

N

CHAVE DE IMPACTO SEM FIO 3/4" 1300NM COM ESTOJO

CONTÉM

REF.	DESCRIÇÃO					€
60015	6.0 AH BATERIA DE LITIO	1.00	-	20	630	138,00€
60016	CARREGADOR 20V - 4A	0.80	-	5	210	49,00€
60048	CHAVE DE IMPACTO COM MOTOR SEM ESCOVAS 3/4" 1300NM	3.26	-	4	64	366,00€

Esta ferramenta foi concebida para apertar e desapertar parafusos e porcas que requerem exercer um alto torque de aperto. Está equipado com uma luz de trabalho LED e um seletor de sentido de rotação que também permite bloquear o gatilho e evitar o arranque acidental da ferramenta.

Possui 5 engrenagens diferentes, 3 para apertar e 2 para desapertar, permitindo ajustar a velocidade dependendo do trabalho a ser executado. Além disso, graças à sua forma ergonômica, consegue-se uma maior aderência e precisão.

- MOTOR BRUSHLESS
- ILUMINAÇÃO DE FUNDO LED
- INTERRUPTOR DO SENTIDO DE ROTAÇÃO PARA FRENTE/TRÁS
- ALÇA ERGONÔMICA
- 5 ENGRENAGENS DIFERENTES
- GANCHO PARA CINTO

OS COMPARTIMENTOS NAS NOSSAS CAIXAS SÃO COMPATÍVEIS COM BATERIAS DE 4.0AH E 6.0AH.



60048

366,00€

3.26	-	4	64

N

CHAVE DE IMPACTO COM MOTOR SEM ESCOVAS 3/4" 1300NM

BATERIA NÃO INCLUÍDA.



REPOSIÇÕES DISPONÍVEIS

60005

132,00€

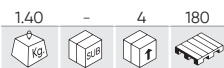

CHAVE DE IMPACTO BRUSHLESS

BATERIA NÃO INCLUÍDA.

Esta ferramenta foi projetada para apertar rapidamente parafusos e porcas e é especialmente útil ao trabalhar com parafusos longos e materiais duros. O driver está equipado com iluminação LED da área de trabalho para um trabalho mais confortável e preciso, um mandril de troca rápida hexagonal de 1/4" de polegada para rápida instalação e remoção do bico, além de um gatilho com uma função de trava para impedir o início acidental da ferramenta.

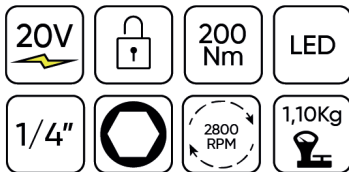

- A MOTOR BRUSHLESS
- B ILUMINAÇÃO DE FUNDO LED
- C INTERRUPTOR DO SENTIDO DE ROTAÇÃO PARA FRENTE/TRÁS
- D ALÇA ERGONÔMICA
- E 5 ENGENRAGENS DIFERENTES
- F GANCHO PARA CINTO
- G BATERIA NÃO INCLUÍDA



ACESSÓRIOS E PEÇAS SOBRESSALENTES

PÁGINA 126

60024

190,00€



ROQUETE ELÉCTRICO DE 1/2" BRUSHLESS - 12V

BATERIA NÃO INCLUÍDA.

Esta ferramenta foi projetada para apertar/desapertar os prendedores em locais de difícil acesso.

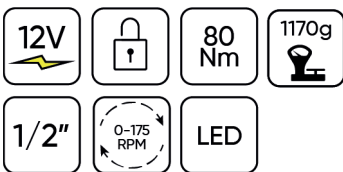

- A CHAVE QUADRADA DE 1/2 "
- B MUDANÇA DE DIREÇÃO: PARA FRENTE / PARA TRÁS
- C LUZ DE TRABALHO LED EMBUTIDA
- D INDICADOR DE NÍVEL DE BATERIA
- E CHAVE DE BLOQUEIO
- F VELOCIDADE VARIÁVEL
- G PROTEÇÃO DE SOBRECARGA

CONTÉM

REF.	DESCRIÇÃO					€
60025	CARREGADOR DE 12 V - PARA REF. 60026	0.30	5	4	700	31,60€
60026	BATERIA DE ION DE LÍTIO 2.0 A*H SAMSUNG - PARA REF. 60024	0.20	5	40	1400	37,90€



60023

212,00€



MARTELO PERCUTOR BRUSHLESS

BATERIA NÃO INCLUÍDA.

Ferramenta desenhada para realizar tarefas de cinzelar e perfurar com impacto em concretos e tijolos.



- A MOTOR BRUSHLESS
- B MEDIDOR DE PROFUNDIDADE
- C TAMPAS PROTETORA CONTRA POEIRA
- D MANDRIL DE APERTO RÁPIDO PARA FERRAMENTA COM HASTE SDS
- E INTERRUPTOR DO MODO DE OPERAÇÃO
- F INTERRUPTOR DA DIREÇÃO DE ROTAÇÃO
- G ALÇA ERGONÔMICA
- H ILUMINAÇÃO DE FUNDO LED
- I BATERIA NÃO INCLUÍDA



ACESSÓRIOS E PEÇAS SOBRESSALENTES

PÁGINA 123



- CONTÉM**
- 1 PÇ. TAMPAS PROTETORA CONTRA POEIRA
 - 1 PÇ. MEDIDOR DE PROFUNDIDADE
 - 1 PÇ. ALÇA ADICIONAL
 - 1 PÇ. CINZEL PONTIAGUDO
 - 1 PÇ. CINZEL PLANO
 - BROCAS SDS: Ø8/10/12 X 150 MM

60006

182,00€



BERBEQUIM PERCUTOR COM MOTOR BRUSHLESS 2 VELOCIDADES

BATERIA NÃO INCLUÍDA.

Esta ferramenta foi projetada para perfurar madeira e metal, operações de perfuração principalmente em alvenaria, concreto, pedra e tijolo vermelho, bem como para apertar/desapertar e desaparafusar parafusos e porcas.



- A MOTOR BRUSHLESS
- B ILUMINAÇÃO DE FUNDO LED
- C INTERRUPTOR DO SENTIDO DE ROTAÇÃO PARA FRENTE/TRÁS
- D ALÇA ERGONÔMICA
- E GANCHO PARA CINTO
- F BATERIA NÃO INCLUÍDA



Alça adicional



ACESSÓRIOS E PEÇAS SOBRESSALENTES

PÁGINA 124

60047C

318,00€



N

FURADEIRA PERCUTORA SEM FIO DE 2 VELOCIDADES COM CAIXA

CONTÉM

REF.	DESCRIÇÃO					€
60013	4.0 AH BATERIA DE LITIO	0.75	-	5	700	80,00€
60016	CARREGADOR 20V - 4A	0.80	-	5	210	49,00€

Esta ferramenta foi projetada para perfurar diferentes tipos de materiais. Pode realizar tarefas de perfuração em madeira e metal e perfuração de impacto, mais comuns em alvenaria, em concreto, pedra e tijolo vermelho. Além disso, pode atarraxar, desatarraxar ou retirar porcas e parafusos. Para tanto, dispõe de um anel de regulação que permite escolher entre 20 torques diferentes.

Tem seletor de velocidade e seletor de avanço/retrocesso, para definir o sentido de rotação para a esquerda ou para a direita. Esse seletor, se deixado na posição intermédia, trava o gatilho para evitar o acionamento acidental da ferramenta.

Equipada com LED para melhor visualização da área de trabalho. Tem um gancho para cinto e uma alça auxiliar para melhor empunhadura.



- MOTOR BRUSHLESS
- ILUMINAÇÃO DE FUNDO LED
- INTERRUPTOR DO SENTIDO DE ROTAÇÃO PARA FRENTE/TRÁS
- ALÇA ERGONÔMICA
- 5 ENGRENAGENS DIFERENTES
- GANCHO PARA CINTO
- ALÇA ADICIONAL

OS COMPARTIMENTOS NAS NOSSAS CAIXAS SÃO COMPATÍVEIS COM BATERIAS DE 4.0AH E 6.0AH.



REPOSIÇÕES DISPONÍVEIS

ACESSÓRIOS E PEÇAS SOBRESSALENTES

PÁGINA 124



60009

168,00€

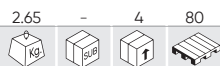

POLIDOR COM MOTOR BRUSHLESS

BATERIA NÃO INCLUÍDA.

A ferramenta foi projetada para um acabamento to limpo, como polir e arredondar cantos e arestas, além de obter superfícies lisas com um disco e uma almofada de polimento.



- A MOTOR BRUSHLESS
- B INTERRUPTOR DE 9 VELOCIDADES:
800, 1000, 1200, 1400, 1600, 1800, 2000, 2200, 2400 RPM
- C INTERRUPTOR DE SEGURANÇA
- D ALÇA SUAVE
- E ALÇA ADICIONAL EM FORMA DE D
- F BOTÃO DE BLOQUEIO DO EIXO
- G ALMOFADA DE POLIMENTO
- H BATERIA NÃO INCLUÍDA



CHAVE SEXTAVADA



REPOSIÇÕES DISPONÍVEIS



60033

104,00€



LIXADORA BRUSHLESS

BATERIA NÃO INCLUÍDA.

Esta ferramenta foi projetada para lixar madeira, ferro, plástico e materiais semelhantes, usando lixa adequada. Esta lixadora foi projetada com três velocidades, uma alça confortável e um saco de pó embutido.

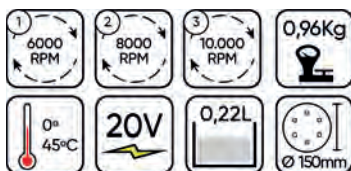

- A MOTOR BRUSHLESS
- B INTERRUPTOR ON /BOTÃO DE CONTROLE DE VELOCIDADE
- C INTERRUPTOR OFF
- D COLETOR DE POEIRA
- E BASE
- F BATERIA NÃO INCLUÍDA



REPOSIÇÕES DISPONÍVEIS

60049C

329,00€



N

REBARBADORA ÂNGULAR BRUSHLESS 125MM COM CAIXA

CONTÉM

REF.	DESCRIÇÃO					€
60013	4.0 AH BATERIA DE LITIO	0.75	-	5	700	80,00€
60016	CARREGADOR 20V - 4A	0.80	-	5	210	49,00€

BATERIA NÃO INCLUÍDA.

A rebarbadora sem fio foi concebida para efetuar todo o tipo de trabalhos de corte, polimento e lixação. Inclui um cabo frontal e uma capa de proteção.



TAMPA DO REBOLO

ALÇA ADICIONAL

BATERIA NÃO INCLUÍDA

OS COMPARTIMENTOS NAS NOSSAS CAIXAS SÃO COMPATÍVEIS COM BATERIAS DE 4.0AH E 6.0AH.



REPOSIÇÕES DISPONÍVEIS

ACESSÓRIOS E PEÇAS SOBRESSALENTES

PÁGINA 127

60028

142,00€



REBARBADORA ÂNGULAR BRUSHLESS - 125MM

BATERIA NÃO INCLUÍDA.

A rebarbadora sem fio foi concebida para efetuar todo o tipo de trabalhos de corte, polimento e lixação. Inclui um cabo frontal e uma capa de proteção.



CHAVE



REPOSIÇÕES DISPONÍVEIS

ACESSÓRIOS E PEÇAS SOBRESSALENTES

PÁGINA 127

60019

178,00€

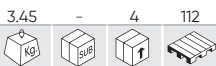

SERRA SABRE COM MOTOR BRUSHLESS

BATERIA NÃO INCLUÍDA.

Esta ferramenta foi projetada para cortar uma grande variedade de materiais e é amplamente utilizada. O design permite a substituição rápida e conveniente da lâmina de serra devido ao suporte de aperto rápido e é caracterizado por uma velocidade de corte ajustável, dependendo da operação a ser executada.



- A MOTOR BRUSHLESS
- B LÂMINA DE SERRA
- C SAPATO
- D SUPORTE DE APERTO RÁPIDO
- E BOTÃO DE BLOQUEIO DO BOTÃO DE LANÇAMENTO
- F ALÇA SUAVE
- G BATERIA NÃO INCLUÍDA



ACESSÓRIOS E PEÇAS SOBRESSALENTES

PÁGINA 128

CONTÉM
1 PÇ. LÂMINA DE MADEIRA
1 PÇ. LÂMINA DE METAL

60020

175,00€



PLAINA BRUSHLESS

BATERIA NÃO INCLUÍDA.

Esta ferramenta foi projetada para trabalhar com madeira. Permite obter uma superfície lisa da madeira e fazer uma forma cônica, se necessário.

A plaina é equipada com uma base de liga de alumínio para posicionamento preciso, um sistema de coleta de poeira para coletar poeira do processamento de madeira e um botão de trava de gatilho para impedir o início acidental da ferramenta.

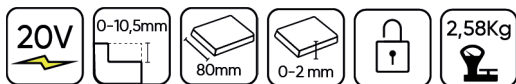

- A MOTOR BRUSHLESS
- B BOTÃO DE TRAVAMENTO
- C BOTÃO DE AJUSTE PARA PROFUNDIDADE DE AMOSTRAGEM
- D GUIA DE CORTE PARALELO
- E GUIA DE PROFUNDIDADE DE CHANFRAMENTO
- F BOTÃO DE AJUSTE DA GUIA DE CHANFRAMENTO
- G PORTA DE REMOÇÃO DE POEIRA
- H RANHURA EM V
- I BATERIA NÃO INCLUÍDA



CONTÉM
1 PÇ. BOTÃO DE AJUSTE DA PROFUNDIDADE DE CHANFRAMENTO
1 PÇ. GUIA PARALELO
3 PÇ. BOTÕES DE AJUSTE
1 PÇ. CHAVE

60010

170,00€

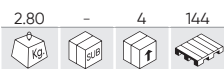

SERRA TICO-TICO BRUSHLESS

BATERIA NÃO INCLUÍDA.

Esta ferramenta foi projetada para serrar tais materiais como madeira, aço, plástico e metal.

A serra de vaivém está equipada com um mecanismo pendular de 4 posições: 3 posições para corte orbital e 1 posição para corte direto, o que permite escolher a velocidade de corte ideal da lâmina para a dureza do material

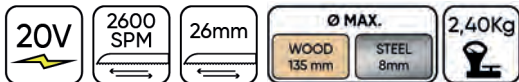

- A MOTOR BRUSHLESS
- B TAMPa PROTETORA DA LÂMINA
- C SUPORTE SEM CHAVE
- D LÂMINA DE SERRA
- E REGULADOR DE MOVIMENTO DE BALANÇO
- F ALAVANCA DE AJUSTE DO SAPATO
- G BOTÃO DE BLOQUEIO DO BOTÃO DE PARTIDA
- H BATERIA NÃO INCLUÍDA



CONTÉM
 1 PÇ. DISCO DE MADEIRA
 1 PÇ. GUIA DE BORDA
 1 PÇ. TUBO DE POEIRA



ACESSÓRIOS E PEÇAS SOBRESSALENTES

PÁGINA 128

60007

170,00€



SERRA CIRCULAR COM MOTOR BRUSHLESS

BATERIA NÃO INCLUÍDA.

Esta ferramenta foi projetada para serrar madeira. Uma serra circular de 165mm de diâmetro e 24 dentes é ideal para cortes longitudinais/transversais retos, bem como para serrar tábuas e painéis de madeira num ângulo de até 45°.



- A MOTOR BRUSHLESS
- B ALAVANCA PARA A TAMPa PROTETORA INFERIOR
- C SAPATO
- D TAMPa PROTETORA INFERIOR
- E ALÇA DE TRAVAMENTO DE ÂNGULO DE CORTE
- F ALÇA FRONTAL
- G BOTÃO DE BLOQUEIO DO GATILHO
- H BATERIA NÃO INCLUÍDA



CONTÉM
 1 PÇ. DISCO TCT DE 165 MM 24T
 1 PÇ. GUIA PARA BORDA
 1 PÇ. CHAVE ALLEN



ACESSÓRIOS E PEÇAS SOBRESSALENTES

PÁGINA 128

60011

175,00€

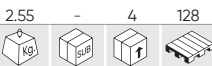

SERRA CIRCULAR COM MOTOR BRUSHLESS

BATERIA NÃO INCLUÍDA.

Esta ferramenta foi projetada para serrar madeira. A serra circular com um diâmetro de 115 mm com 24 dentes é ideal para cortes longitudinais/transversais diretos e para serrar até 45° de tábuas e painéis de madeira. A serra também possui um botão de trava de gatilho para impedir o arranque acidental da ferramenta e uma cobertura de alumínio.



- A MOTOR BRUSHLESS
- B TAMPA PROTETORA INFERIOR DA LÂMINA
- C ALAVANCA DA TAMPA PROTETORA INFERIOR
- D PLACA DE BASE
- E TAMPA PROTETORA SUPERIOR DA LÂMINA
- F GUIA PARA CORTES
- G BOTÃO DE BLOQUEIO
- H BATERIA NÃO INCLUÍDA



- CONTÉM**
- 1 PÇ. DISCO TCT DE 115MM 24T
 - 1 PÇ. GUIA PARA BORDA
 - 1 PÇ. TUBO DE POEIRA
 - 1 PÇ. CHAVE ALLEN



REPOSIÇÕES DISPONÍVEIS

ACESSÓRIOS E PEÇAS SOBRESSALENTES

PÁGINA 128

60022

470,00€

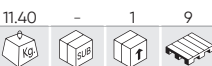

SERRA DE ESQUADRIA MOTOR BRUSHLESS

BATERIA NÃO INCLUÍDA.

Esta ferramenta foi projetada para serrar madeira e materiais similares. A ferramenta permite executar cortes oblíquos quando é necessário um corte inclinado ao longo da superfície da peça de trabalho, cortes num ângulo usados, como regra, para conexões que formam um ângulo de 90°, bem como cortes combinados quando é necessário um corte angular e um corte ao longo da borda e da superfície frontal da peça de trabalho.

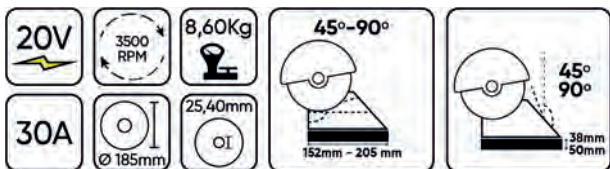

- CONTÉM**
- 1 PÇ. SERRA CIRCULAR DE 40 DENTES
 - 1 PÇ. BRAÇADEIRA
 - 1 PÇ. CHAVE DE LÂMINA
 - 1 PÇ. SACO DE PÓ



REPOSIÇÕES DISPONÍVEIS

ACESSÓRIOS E PEÇAS SOBRESSALENTES

PÁGINA 128



60032

123,00€

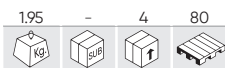

PISTOLA PARA SILICONE A BATERIA

BATERIA NÃO INCLUÍDA.

Esta ferramenta foi projetada para preencher qualquer fenda ou rachadura numa ampla variedade de materiais, como metal, vidro, madeira e cerâmica.



- A SUPORTE DE CARTUCHO
- B PISTÃO
- C HASTE DO PISTÃO
- D MANIVELA DA HASTE DO PISTÃO
- E GATILHO DE MOVIMENTO DA HASTE DO PISTÃO
- F CONTROLADOR DE VELOCIDADE
- G LUZ LED
- H BATERIA NÃO INCLUÍDA



60038

255,00€



PISTOLA DE GRAXA PNEUMÉTICA ELLÉTRICA

BATERIA NÃO INCLUÍDA.

Esta ferramenta é uma pistola de graxa. Alimentada por bateria, a ferramenta é fácil de usar e transportar.



- A RODA DE AJUSTE DA TAXA DE FLUXO DE GRAXA
- B BOTÃO DE BLOQUEIO
- C LED DE ILUMINAÇÃO
- D MANGUEIRA FLEXÍVEL
- E TUBO DE GRAXA
- F VÁLVULA DE SEGURANÇA DE SAÍDA DE AR
- G BATERIA NÃO INCLUÍDA



60041

77,00€



MULTIFERRAMENTA

BATERIA NÃO INCLUÍDA.

Uma variedade de acessórios pode ser usada com a ferramenta oscilante multifuncional para se adequar a uma ampla variedade de tarefas. A ferramenta é especialmente útil para limpeza, lixamento e serragem profunda em espaços apertados.

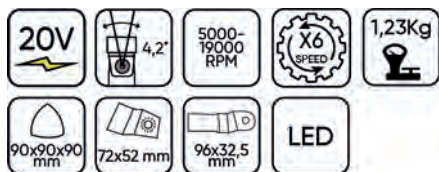

- A MOTOR BRUSHLESS
- B ALAVANÇA DE APERTO
- C GRAMPO FIXADOR
- D VOLANTE PARA SELEÇÃO DE VELOCIDADE
- E LANTERNA DE TRABALHO
- F SUPORTE DA FERRAMENTA
- G BATERIA NÃO INCLUÍDA



- CONTÉM**
- 1 PÇ. LÂMINA DE SERRA
 - 1 PÇ. FOLHA DE LIXA
 - 1 PÇ. PLACA DE LIXA
 - 1 PÇ. RASPADOR
 - 1 PÇ. ARRUELA
 - 1 PÇ. ALÇA

60037

222,00€



GRAMPEADOR ELÉTRICO

BATERIA NÃO INCLUÍDA.

A ferramenta é projetada para grampear papelão, materiais isolantes, tecido, folha, couro e materiais semelhantes à madeira ou outras superfícies semelhantes por meio de um martelo de alta potência usando ar comprimido.



- A ILUMINAÇÃO LED
- B ESTOJO
- C LED INDICADOR
- D VOLANTE PARA SELEÇÃO DE VELOCIDADE
- E ALÇA DE MUDANÇA DE ACIONAMENTO
- F INTERRUPTOR DE ILUMINAÇÃO LED
- G BATERIA NÃO INCLUÍDA



ACESSÓRIOS E PEÇAS SOBRESSALENTES

PÁGINA 127

GRAMPOS DO TIPO LEVE COM PARTE SUPERIOR ESTREITO DE TAMANHO 18

LONGITUD MÁXIMA DE LAS GRAPAS	40 mm
LARGURA MÁXIMA DA SECÇÃO TRANSVERSAL DOS AGRAFOS	1.2 mm
ESPESSURA MÁXIMA DA SECÇÃO TRANSVERSAL DOS AGRAFOS	1 mm
MÁX. TAMANHO DA PARTE SUPERIOR DO GRAMPO	6 mm

PREGOS SEM TAMPA DE TAMANHO 18

MÁX. COMPRIMENTO DE PREGO	50 mm
LARGURA MÁXIMA DA SECÇÃO TRANSVERSAL DO PREGO	1.25 mm
ESPESSURA MÁXIMA DA SECÇÃO TRANSVERSAL DO PREGO	1.05 mm

60042

106,00€

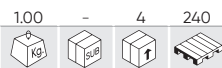

PISTOLA DE AR QUENTE A BATERIA

BATERIA NÃO INCLUÍDA.

A pistola de ar quente elétrica se utiliza principalmente para a retração de PVC, soldar, dobragem de peças de plástico, secado em geral, função e descongelamento.

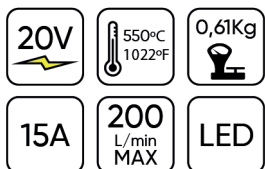

- A TAMPA FRONTAL
- B BICO
- C ILUMINAÇÃO LED
- D BLOQUEADOR DO INTERRUPTOR DE ALIMENTAÇÃO
- E GANCHO METÁLICO
- F BATERIA NÃO INCLUÍDA



REPOSIÇÕES DISPONÍVEIS

60043

123,00€



PISTOLA DE PINTURA SEM FIO

BATERIA NÃO INCLUÍDA.

Esta ferramenta foi projetada para pulverizar tinta em ambientes fechados e ao ar livre.



- A REGULADOR DE FLUXO (TAXA DE FLUXO)
- B TANQUE
- C BLOQUEADOR DO TANQUE
- D FILTRO DE AR
- E BATERIA NÃO INCLUÍDA



REPOSIÇÕES DISPONÍVEIS

USE-OS COM BATERIAS JBM: UMA ÚNICA BATERIA ADEQUADA PARA TODAS AS FERRAMENTAS

TRÊS TIPOS DE BATERIA E DOIS TIPOS DE CARREGADOR.
ESCOLHA O QUE VOCÊ PREFERIR!

**Pilhas e carregadores NÃO INCLUÍDOS nas ferramentas.*



60001

88,00€

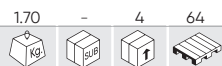

ASPIRADOR PORTÁTIL SEM FIO

BATERIA NÃO INCLUÍDA.

Este aspirador elétrico sem fio foi projetado para aspirar qualquer material que não seja prejudicial à saúde.



- A COPO DE PÓ
- B BOTÃO DE LIBERAÇÃO DO COPO DE PÓ
- C INTERRUPTOR ON/OFF
- D CARCAÇA DO MOTOR
- E BOCAL DE FENDA
- F BOCAL DE ESCOVA
- G BOCAL DE CHÃO
- H TUBO DE EXTENSÃO
- I BATERIA NÃO INCLUÍDA



REPOSIÇÕES DISPONÍVEIS

CONTÉM

REF.	DESCRIÇÃO					€
14950	TUBO DE EXTENSÃO PARA REF. 60001	0.08	5	10	-	6,50€
14951	BOCAL DE FENDA PARA REF. 60001	0.01	-	10	-	9,50€
14952	BOCAL DE CHÃO REF. 60001	0.15	-	5	-	19,00€
14953	ESCOVA PARA REF. 60001	0.05	-	10	-	8,50€

60003

110,00€



COMPRESSOR DE AR A BATERIA

BATERIA NÃO INCLUÍDA.

Este compressor permite inflar rodas de carros e motos, bolas, lanchas infláveis, colchões infláveis, etc.



- A LUZ LED
- B BOTÃO DE LIGAR COM LUZ LED
- C SELECTOR DE MODO DE TRABALHO
- D BOTÕES DE SELECÇÃO DE PRESSÃO
- E CONECTOR USB
- F MANGUEIRA DE ALTA PRESSÃO
- G MANGUEIRA DE ALTA CAPACIDADE
- H CONECTOR PARA TOMADA DE ISQUEIRO 12V
- I BATERIA NÃO INCLUÍDA



CONTÉM



REPOSIÇÕES DISPONÍVEIS

60004

79,00€



FOCO DE ILUMINAÇÃO LED

BATERIA NÃO INCLUÍDA.

Esta lâmpada LED de operação foi projetada para criar a iluminação necessária na área de trabalho e em outros locais. Quando a bateria está descarregada, a lâmpada pode ser conectada a uma rede com uma tensão de 230 V usando um cabo de rede localizado na parte traseira do dispositivo.



- A INTERRUPTOR (ON/OFF)
- B CABEÇA ROTATIVA DA LÂMPADA DE TRABALHO
- C MATRIZ DE LED
- D TRAVA DA POSIÇÃO LATERAL
- E CABO DE REDE
- F BATERIA NÃO INCLUÍDA



REF.	DESCRIÇÃO					€
15049	TRIPODE PARA FAROL DE TRABALHO LED (REF. 60004)	2.10	-	4	120	37,40€

60035

30,00€



LÂMPADA DE TRABALHO PORTÁTIL LED

BATERIA NÃO INCLUÍDA.

Esta lâmpada de trabalho LED é projetada para fornecer a iluminação necessária na área de trabalho e em outros locais. É alimentada por uma bateria portátil de íon de lítio, tornando-a portátil e ideal para todos os locais de trabalho e situações onde a energia elétrica é limitada.

O difusor da lâmpada LED fornece um fluxo luminoso de 500 e 1000 lumens, e o mecanismo giratório da lâmpada (90°) permite ajustar o ângulo desejado. Também está incluída uma alça macia para um manuseio mais confortável e um gancho de suspensão para prender a outro objeto.



- A DIFUSOR
- B MECANISMO GIRATÓRIO
- C GANCHO DE SUSPENSÃO
- D INTERRUPTOR ON/OFF
- E BATERIA NÃO INCLUÍDA



60039

265,00€



LAVADORA DE ALTA PRESSÃO A BATERIA BRUSHLESS

BATERIA NÃO INCLUÍDA.

A lavadora de alta pressão com motor BRUSHLESS é projetada para a limpeza de veículos, equipamentos, ferramentas, móveis de jardim, etc.



- A MOTOR BRUSHLESS
- B BICO ROTATIVO DE 5 POSIÇÕES
- C ACOPLAMENTO DE LIBERAÇÃO RÁPIDA DO BICO
- D TUBO
- E INDICADOR DE PRESSÃO
- F CHAVE SELETORA DE PRESSÃO
- G INTERRUPTOR DE BLOQUEIO
- H ACOPLAMENTO DE LIBERAÇÃO RÁPIDA DA MANGUEIRA
- I BATERIA NÃO INCLUÍDA



REPOSIÇÕES
DISPONÍVEIS



60027

99,00€



PULVERIZADOR ELÉTRICO INDUSTRIAL DE MOCHILA COM TANQUE DE 15L

BATERIA NÃO INCLUÍDA.

A ferramenta é adequada para a desinfecção de casas particulares, locais públicos, fazendas de gado, jardins, etc., e permite destruir todas as partículas perigosas, impedir a sua propagação e impedir a reprodução de insetos e o desenvolvimento de doenças. Manivela inteligente com intertravamento para operação contínua.

Também estão incluídos no pacote 4 bicos com capacidade e fluxo específicos, dependendo dos requisitos: 1 bico cônico oco, 1 bico cônico duplo oco, 1 bico ajustável com 4 orifícios, 1 bico do ventilador.



- A ALÇA PARA FÁCIL TRANSPORTE
- B ALMOFADA RESPIRÁVEL E ERGONÔMICA
- C TAMPA DE ENCHIMENTO COM TRAVA
- D SUPORTE DE PULVERIZAÇÃO TELESCÓPICO
- E BATERIA NÃO INCLUÍDA

NÃO ACEITA BATERIAS DE 6,0 AH

CONTÉM



60029

240,00€

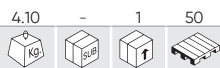

SERRA ELÉTRICA COM MOTOR BRUSHLESS

BATERIA NÃO INCLUÍDA.

Esta ferramenta florestal foi projetada para tarefas como derrubar, desgalhar, serrar e cortar árvores.

A ferramenta está equipada com uma alça para ajustar a tensão da barra guia e da corrente, um freio da corrente para parar a corrente ao recuar e um prendedor da corrente para segurá-la se ela quebrar ou se soltar. A ferramenta também possui um sistema de lubrificação automática da corrente e um botão de travamento do gatilho para evitar partidas acidentais. A ferramenta consiste numa barra guia, uma corrente e uma cobertura para proteger a barra e a corrente durante o transporte e armazenamento.

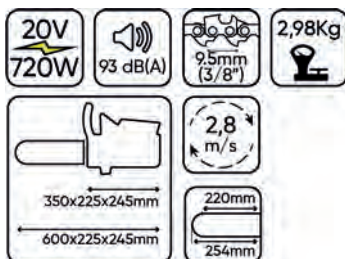

- A MOTOR BRUSHLESS
- B CORRENTE DE SERRA
- C BARRA GUIA
- D FREIO DA CORRENTE/PROTEÇÃO DIANTEIRA
- E ALÇA FRONTAL
- F BOTÃO DE BLOQUEIO
- G TAMPA DO TANQUE DE ÓLEO
- H BATERIA NÃO INCLUÍDA



CONTÉM



60030

112,00€



SOPRADOR DE FOLHAS

BATERIA NÃO INCLUÍDA.

Esta ferramenta foi projetada para recolher folhas, grama, papel e materiais semelhantes. Leveza de construção e alimentação por bateria facilitam o transporte da ferramenta de um local para outro. O design apresenta um interruptor de fluxo de ar alto/ baixo e interruptor de volume e uma alça macia para fácil operação.



- A MOTOR BRUSHLESS
- B TUBO
- C PONTA DO TUBO DO SOPRADOR
- D CORPO
- E BATERIA NÃO INCLUÍDA

NÃO ACEITA BATERIAS DE 6,0 AH



60031

142,00€

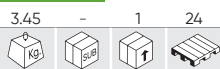

ELETROSERRA TELESCÓPICA

BATERIA NÃO INCLUÍDA.

Esta ferramenta foi projetada para tarefas de jardinagem rápidas e fáceis, como corte de cercas vivas ou arbustos. Leveza de construção e alimentação por bateria facilitam o transporte da ferramenta de um local para outro.

O kit inclui uma tampa protetora de lâmina para manter o corta-sebes em boas condições, uma cobertura para ajudar a manter aparas ou outros detritos longe das mãos e olhos do operador e uma alça extra para maior controle e um ambiente de trabalho confortável. Além disso, o design oferece dois interruptores e um botão de bloqueio, que evita o acionamento acidental da ferramenta.



- A MOTOR BRUSHLESS
- B LÂMINA DE CORTE
- C PORTA-LÂMINA
- D COBERTURA
- E ALÇA AUXILIAR
- F INTERRUPTOR ADICIONAL
- G BOTÃO DE BLOQUEIO
- H ALÇA TRASEIRA
- I BATERIA NÃO INCLUÍDA



CONTÉM
TAMPA PROTETORA



60040

440,00€



MÁQUINA DE JARDIM MULTIFUNÇÃO BATERIA (4 EM 1)

BATERIA NÃO INCLUÍDA.

A ferramenta elétrica multifuncional 4 em 1 para jardim foi projetada para uma ampla variedade de tarefas ao ar livre, como limpar espaços verdes, aparar sebes, cortar galhos e muito mais. A ferramenta é ideal para a manutenção completa do jardim.

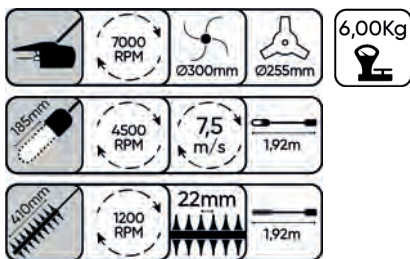

- A MOTOR BRUSHLESS
- B TAMPA DE PROTEÇÃO
- C LÂMINA DE TRÊS DENTES
- D LÂMINA
- E SERRA
- F ALÇAS
- G ROÇADEIRA
- H CABEÇA DE CORTE
- I CORTA-SEBES PARA APARAR SEBE
- J SERRA DE BARRA
- K BATERIA NÃO INCLUÍDA



52598

1.080,00€

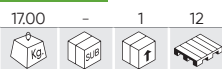

ROBÔ CORTA-RELVA

Cortador de grama robótico moderno e funcional, perfeito para o cuidado e a manutenção do seu gramado e dos seus espaços verdes. Equipado com motor sem escovas, alimentado por uma potente bateria de 5200 Ah, com autonomia de cerca de 150 minutos. A plataforma de corte com três lâminas de aço permite efetuar o corte de cobertura vegetal. Este sistema de corte apara a grama em corte muito finos, deixando-a cair diretamente no solo em seguida, dando ao gramado um aspeto impecável sem exigir a remoção dos restos. Além disso, com esse corte, a grama deixada no gramado se decompõe e se torna um nutriente para o solo, criando um ciclo biológico interiormente natural. Os cabos e estacas perimetrais, fornecidos com o produto, permitem uma instalação fácil e sem o uso de ferramentas.

5200 mAh Capacidade da bateria battery capacity	1400m ² Superfície de corte mowing area	IP X4	DC 15-25.5V tensão de alimentação da bateria battery voltage	2,5h	22m/min
115,44W consumo de energia power consumption	AC 100-240V 50/60Hz tensão de entrada input voltage	7,5Kg	2h	70 dB(A)	50-35,5-24 cm



CONEXÃO DE APP



- A MOTOR BRUSHLESS
- B BOTÃO STOP
- C ESTAÇÃO DE CARREGAMENTO
- D RODA TRASEIRA
- E TAMPA DA ALÇA

60045

298,00€

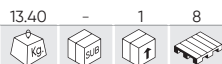

CORTA-RELVA SEM FIO

BATERIA NÃO INCLUÍDA.

Este corta-relva sem fios ajuda-o a manter o seu jardim em perfeitas condições. Está equipado com um motor sem escovas, o que aumenta a eficácia e reduz o nível de ruído. Também é muito leve e fácil de utilizar.

40V	800W	35L	11,6 Kg.
3.300 RPM	6x 25-75mm	152-203mm Ø	370mm Ø
96 dB(A)	IP X1	4.0A	11,40Kg



- A MOTOR BRUSHLESS
- B CORTADOR DE GRAMA
- C ALÇA
- D SACO RECOLHEDOR DE GRAMA

TRABALHOS COM 2 BATERIAS DE 4AH (NÃO INCLUÍDAS)



**USE-OS COM BATERIAS JBM:
UMA ÚNICA BATERIA ADEQUADA
PARA TODAS AS FERRAMENTAS**

TRÊS TIPOS DE BATERIA E DOIS TIPOS DE CARREGADOR.
ESCOLHA O QUE VOCÊ PREFERIR!

**Pilhas e carregadores NÃO INCLuíDOS nas ferramentas.*



BATERIA DE LITIO



INDICADOR DE ENERGIA



PROTEÇÃO CONTRA CURTO-CIRCUITO



PROTEÇÃO CONTRA SUPERAQUECIMENTO



PROTEÇÃO CONTRA SOBRECARGA



60012



48,00€



60013



80,00€



60015



138,00€



PARA REF. 60024

60026

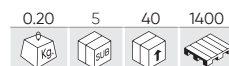

37,90€



CARREGADOR



INDICADOR DE ENERGIA



PROTEÇÃO CONTRA CURTO-CIRCUITO



PROTEÇÃO CONTRA SUPERAQUECIMENTO



PROTEÇÃO CONTRA SOBRECARGA



60016



49,00€

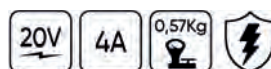

2.0AH
30min +/-10min
4.0AH
60min +/-15min
6.0AH
90min +/-15min



RÁPIDO

60017



64,00€



2.0AH
30min +/-10min
4.0AH
45min +/-10min
6.0AH
60min +/-15min



PARA REF. 60026

60025

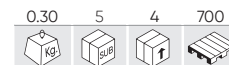

31,60€

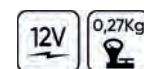

2.0AH
60min +/-10min

ACESSÓRIOS



REF. DESCRIÇÃO	mm						€
14622 BANDEJA PARA REF. 60001, 60003, 60004, 60020	320x180	A	0.95	-	10	360	17,00€
14623 GANCHO PARA REF. 60005, 60006, 60018	70x84	B	0.10	-	10	800	8,00€
14624 BANDEJA PARA REF. 60007, 60010, 60011	290x160	C	0.65	-	10	300	17,00€
14625 GANCHO PARA REF. 60008, 60009	40x200x100	D	0.50	-	10	700	14,00€
14626 GANCHO PARA REF. 60023	115x70	E	0.10	-	10	-	7,00€
16364 CABIDE PONTA COMPRIDA 280MM	280		0.20	-	200	-	3,50€

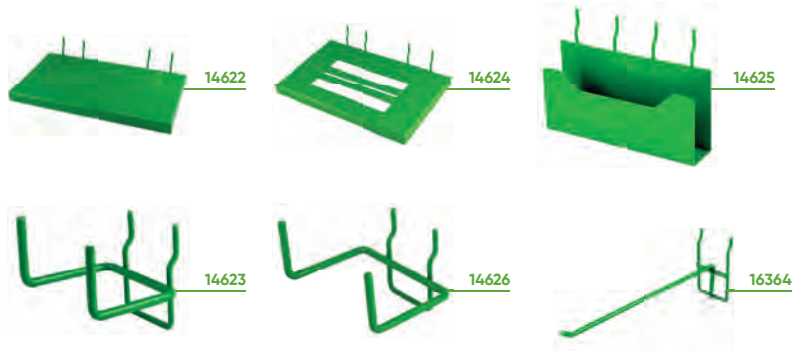

PEÇAS DE REPOSIÇÃO



FORMÃO SDS-PLUS

REF. DESCRIÇÃO				€
14837 FORMÃO DE FINO AFIADO SDS-PLUS 14X250MM	0.25	10	100	3,30€
14838 FORMÃO DE FINO PLANO SDS-PLUS 20X250 MM	0.25	10	100	3,40€
14839 FORMÃO DE FINO PLANO SDS-PLUS 40X250MM	0.29	10	50	4,70€
14840 FORMÃO DE SULCO SDS-PLUS 250MM	0.27	10	50	3,35€



53850 14,90€

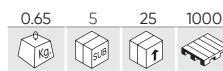

CONJUNTO DE BROCAS PARA BERBEQUIM PERCUTOR



REPOSIÇÕES DISPONÍVEL

REF.	mm				€
14826	Ø 5x110mm	0.05	125	500	1,50€
14828	Ø 6x110mm	0.05	25	500	1,50€
14829	Ø 6x160mm	0.04	25	500	1,50€
14830	Ø 8x110mm	0.04	25	500	1,50€
14831	Ø 8x160mm	0.05	25	500	1,50€
14832	Ø 10x160mm	0.05	25	200	2,00€
14920	Ø 12x160mm	0.10	100	200	2,50€

VOCÊ PODE GOSTAR...

REF.	mm				€
14825	Ø 4x110mm	0.05	100	200	1,50€
14827	Ø 5x160mm	0.04	25	500	2,00€
14833	Ø 10x210mm	0.10	20	200	2,05€
14834	Ø 12x210mm	0.10	100	200	2,50€
14835	Ø 14x210mm	0.10	20	125	3,00€
14836	Ø 16x210mm	0.14	20	120	3,50€



14841

2,58€

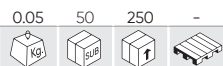

ADAPTADOR SDS-PLUS PARA CARTUCHO DE PERFURAÇÃO DE 1/2 "



14842

9,50€

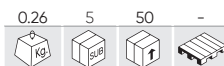

PORTA-BROCAS DE MUDANÇA RÁPIDA 2-13 MM 1/2 "-20 UNF (ROSCA FINA UNIFICADA)



60006
60047C

53860

3,65€

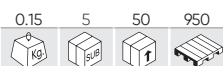

CONJUNTO DE BROCAS PARA CONCRETO 4-10 MM



REPOSIÇÕES DISPONÍVEI

REF.	mm				€
14908	Ø 4x75mm	0.01	50	100	0,60€
14909	Ø 5x80mm	0.01	50	100	0,80€
14910	Ø 6x100mm	0.01	50	100	1,00€
14912	Ø 8x120mm	0.05	50	100	1,55€
14914	Ø 10x120mm	0.04	20	100	2,10€

VOCÊ PODE GOSTAR...

REF.	mm				€
14915	Ø 11x150mm	0.05	20	100	2,65€
14916	Ø 12x150mm	0.06	20	100	2,95€
14917	Ø 13x150mm	0.10	20	100	3,45€



53861

5,45€

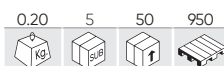

CONJUNTO DE BROCAS PARA CONCRETO 3-10 MM



REPOSIÇÕES DISPONÍVEI

REF.	mm				€
14907	Ø 3x60mm	0.01	50	100	0,50€
14908	Ø 4x75mm	0.01	50	100	0,60€
14909	Ø 5x80mm	0.01	50	100	0,80€
14910	Ø 6x100mm	0.01	50	100	1,00€
14911	Ø 7x100mm	0.01	50	100	1,30€
14912	Ø 8x120mm	0.05	50	100	1,55€
14913	Ø 9x120mm	0.05	50	100	1,90€
14914	Ø 10x120mm	0.04	20	100	2,10€



53859

67,00€



CONJUNTO BROCAS CRANEADAS COM ADAPTADORES



	x6	22, 29, 35, 44, 51, 68mm
	x2	14-30mm, 32-152mm



REPOSIÇÕES DISPONÍVEI

REF.	mm				€
14901	22mm	0.04	10	50	3,60€
14902	29mm	0.08	10	50	4,65€
14903	35mm	0.10	10	50	5,25€
14904	44mm	0.12	10	50	6,85€
14905	51mm	0.12	10	50	8,50€
14906	68mm	0.19	10	50	10,20€
14934	14-30mm	0.07	10	50	4,25€
14935	32-152mm	0.20	10	50	8,45€

KIT DE BROCAS ESPIRAIS HSS 4341

53852 207,00€

4.20 - 4 192

170 PCS **HSS-G 4341**

METAL **1-10 mm**

53856 62,00€

1.32 5 10 550

25 PCS **HSS-G 4341**

METAL **1-13 mm**

53854 27,00€

0.63 5 20 192

19 PCS **HSS-G 4341**

METAL **1-10 mm**

REPOSIÇÕES DISPONÍVEIS

REF.	mm				€
14868	Ø 1x34mm	0.01	50	400	0,55€
14869	Ø 1.5x40mm	0.01	50	400	0,60€
14870	Ø 2x49mm	0.01	50	400	1,00€
14871	Ø 2.5x57mm	0.01	50	400	1,00€
14872	Ø 3x61mm	0.01	50	400	1,00€
14873	Ø 3.5x70mm	0.01	50	400	1,00€
14874	Ø 4x75mm	0.01	50	400	1,00€
14875	Ø 4.5x80mm	0.01	50	400	1,50€
14876	Ø 5x86mm	0.01	50	300	1,50€
14877	Ø 5.5x93mm	0.02	50	300	1,50€
14878	Ø 6x93mm	0.02	25	400	2,00€
14879	Ø 6.5x101mm	0.02	25	400	2,00€
14880	Ø 7x109mm	0.03	25	400	2,50€
14881	Ø 7.5x109mm	0.03	25	400	2,50€
14882	Ø 8x117mm	0.04	25	400	3,00€
14883	Ø 8.5x117mm	0.04	25	400	3,50€
14884	Ø 9x125mm	0.05	25	400	4,00€
14886	Ø 10x133mm	0.06	25	400	4,60€
14887	Ø 10.5x133mm	0.07	25	400	5,00€
14888	Ø 11x142mm	0.08	25	400	6,00€
14889	Ø 11.5x142mm	0.09	25	400	6,50€
14890	Ø 12x151mm	0.10	25	300	7,00€
14891	Ø 12.5x151mm	0.09	25	200	7,50€
14892	Ø 13x151mm	0.09	25	200	8,00€



1x34, 1.5x40, 2x49, 2.5x57, 3x61, 3.5x70, 4x75, 4.5x80, 5x86, 5.5x93, 6x93, 6.5x101, 7x109, 7.5x109, 8x117, 8.5x117, 9x125, 9.5x125, 10x133mm

1x34, 1.5x40, 2x49, 2.5x57, 3x61, 3.5x70, 4x75, 4.5x80, 5x86, 5.5x93, 6x93, 6.5x101, 7x109, 7.5x109, 8x117, 8.5x117, 9x125, 9.5x125, 10x133, 10.5x133, 11x142, 11.5x142, 12x151, 12.5x151, 13x151mm

1x34, 1.5x40, 2x49, 2.5x57, 3x61, 3.5x70, 4x75, 4.5x80, 5x86, 5.5x93, 6x93, 6.5x101, 7x109, 7.5x109, 8x117, 8.5x117, 9x125, 9.5x125, 10x133mm

KIT DE BROCAS ESPIRAIS HSS 4241 PRETO

53851 88,00€

3.80 - 4 192

170 PCS **HSS-G 4241**

METAL **1-10 mm**

53855 24,80€

1.19 5 10 192

25 PCS **HSS-G 4241**

METAL **1-13 mm**

53853 14,40€

0.58 5 20 192

19 PCS **HSS-G 4241**

METAL **1-10 mm**

REPOSIÇÕES DISPONÍVEIS

REF.	mm				€
14843	Ø 1x34mm	0.01	50	400	0,50€
14844	Ø 1.5x40mm	0.01	50	400	0,50€
14845	Ø 2x49mm	0.01	50	400	0,50€
14846	Ø 2.5x57mm	0.01	50	400	0,50€
14847	Ø 3x61mm	0.01	50	400	0,50€
14848	Ø 3.5x70mm	0.01	50	400	0,50€
14849	Ø 4x75mm	0.01	50	400	1,00€
14850	Ø 4.5x80mm	0.01	50	400	1,00€
14851	Ø 5x86mm	0.01	50	300	1,00€
14852	Ø 5.5x93mm	0.01	50	300	1,00€
14853	Ø 6x93mm	0.02	25	400	1,00€
14854	Ø 6.5x101mm	0.02	25	400	1,00€
14855	Ø 7x109mm	0.02	25	400	1,00€
14856	Ø 7.5x109mm	0.03	25	400	1,00€
14857	Ø 8x117mm	0.03	25	400	1,50€
14858	Ø 8.5x117mm	0.04	25	400	1,50€
14859	Ø 9x125mm	0.04	25	400	1,50€
14860	Ø 9.5x125mm	0.05	25	400	2,00€
14861	Ø 10x133mm	0.05	25	400	2,00€
14862	Ø 10.5x133mm	0.06	25	400	2,00€
14863	Ø 11x142mm	0.07	25	400	2,50€
14864	Ø 11.5x142mm	0.07	25	400	2,50€
14865	Ø 12x151mm	0.08	25	300	2,50€
14866	Ø 12.5x151mm	0.09	25	200	3,00€
14867	Ø 13x151mm	0.09	25	200	3,00€



1x34, 1.5x40, 2x49, 2.5x57, 3x61, 3.5x70, 4x75, 4.5x80, 5x86, 5.5x93, 6x93, 6.5x101, 7x109, 7.5x109, 8x117, 8.5x117, 9x125, 9.5x125, 10x133mm

1x34, 1.5x40, 2x49, 2.5x57, 3x61, 3.5x70, 4x75, 4.5x80, 5x86, 5.5x93, 6x93, 6.5x101, 7x109, 7.5x109, 8x117, 8.5x117, 9x125, 9.5x125, 10x133, 10.5x133, 11x142, 11.5x142, 12x151, 12.5x151, 13x151mm

1x34, 1.5x40, 2x49, 2.5x57, 3x61, 3.5x70, 4x75, 4.5x80, 5x86, 5.5x93, 6x93, 6.5x101, 7x109, 7.5x109, 8x117, 8.5x117, 9x125, 9.5x125, 10x133mm

CONJUNTO DE BROCAS HELICOIDAIS HSS-CO5 COBALTO

N

54348 291,00€



170 PCS HSS CO5

METAL 1-10 mm

54314 82,00€



25 PCS HSS CO5

METAL 1-13 mm

54313 43,00€



19 PCS HSS CO5

METAL 1-10 mm



1x34, 1.5x40, 2x49, 2.5x57, 3x61, 3.5x70, 4x75, 4.5x80, 5x86, 5.5x93, 6x93, 6.5x101, 7x109, 7.5x109, 8x117, 8.5x117, 9x125, 9.5x125, 10x133mm

1x34, 1.5x40, 2x49, 2.5x57, 3x61, 3.5x70, 4x75, 4.5x80, 5x86, 5.5x93, 6x93, 6.5x101, 7x109, 7.5x109, 8x117, 8.5x117, 9x125, 9.5x125, 10x133, 10.5x133, 11x142, 11.5x142, 12x151, 12.5x151, 13x151mm

1x34, 1.5x40, 2x49, 2.5x57, 3x61, 3.5x70, 4x75, 4.5x80, 5x86, 5.5x93, 6x93, 6.5x101, 7x109, 7.5x109, 8x117, 8.5x117, 9x125, 9.5x125, 10x133mm

REPOSIÇÕES DISPONÍVEIS

REF.	mm				€
16318	Ø 1x34mm	0.50	25	400	0,50€
16319	Ø 1.5x40mm	0.50	25	400	0,50€
16320	Ø 2x49mm	0.50	25	400	0,50€
16321	Ø 2.5x57mm	0.50	25	400	1,00€
16322	Ø 3x61mm	0.50	25	400	1,00€
16323	Ø 3.5x70mm	0.50	25	400	1,00€
16324	Ø 4x75mm	0.05	25	400	1,50€
16325	Ø 4.5x80mm	0.50	25	400	1,50€
16326	Ø 5x86mm	0.50	25	400	2,00€
16327	Ø 5.5x93mm	0.50	25	400	2,00€
16328	Ø 6x93mm	0.50	25	400	2,50€
16329	Ø 6.5x101mm	0.50	25	400	3,00€
16330	Ø 7x109mm	0.50	25	400	3,50€
16331	Ø 7.5x109mm	0.50	25	400	3,50€
16332	Ø 8x117mm	0.50	25	400	4,00€
16333	Ø 8.5x117mm	0.05	5	200	4,50€
16334	Ø 9x125mm	0.50	25	200	5,50€
16335	Ø 9.5x125mm	0.50	25	200	6,00€
16336	Ø 10x133mm	0.50	25	200	6,50€
16583	Ø 10.5x133mm	0.07	25	200	8,50€
16584	Ø 11x142mm	0.07	25	200	10,50€
16585	Ø 11.5x142mm	0.08	25	200	11,50€
16586	Ø 12x151mm	0.10	25	200	13,00€
16587	Ø 12.5x151mm	0.10	25	200	14,00€
16588	Ø 13x151mm	0.11	25	200	15,00€

53857

27,00€



CONJUNTO DE PONTAS DE IMPACTO COM ADAPTADOR RÁPIDO S2

57 PCS S2



EM EXPOSITOR DE 6 UDS



CONTÉM

	x9	PH	25mm	1x3, 2x3, 3x3
	x9	PZ	25mm	1x3, 2x3, 3x3
	x4	H	25mm	3, 4, 5, 6
	x6	SL	25mm	4x2, 5x2, 6x2
	x14	TX	25mm	10x2, 15x2, 20x2, 25x2, 27x2, 30x2, 40x2
	x7	T	25mm	10, 15, 20, 25, 27, 30, 40
	x7		65mm	PH2, PH3, PZ1, PZ2, T20, T25, SL6
	x1		60mm	

* TAMBÉM ADEQUADO PARA REF. 60005

53858

28,80€



CONJUNTO DE PONTAS COM ADAPTADORES S2- REVESTIMENTO PRETO

33 PCS S2



EM EXPOSITOR DE 6 UDS



CONTÉM

	x4	PH	25mm	1, 2x2, 3
	x3	PZ	25mm	1, 2, 3
	x4	H	25mm	3, 4, 5, 6
	x4	SL	25mm	3, 4, 5, 6
	x6	TX	25mm	10, 15, 20, 25, 30, 40
	x6		75mm	T15, T20, T25, PH2, PZ2, SL5
	x4		48mm	6, 7, 8, 10mm
	x1		60mm	
	x1		80mm	

* TAMBÉM ADEQUADO PARA REF. 60005

54346

11,50€

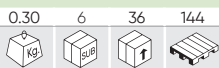

N

CONJUNTO DE 3 ESCOVAS DE LIMPEZA PARA BERBEQUIM

3 PCS PP 1/4"

- A Ø 88mm
- B Ø 100mm
- C Ø 50mm



60037

CONJUNTO DE PREGOS SEM CABEÇA

REF.	mm				€
53999	25x1,25mm	0.20	-	50	2,00€
54000	30x1,25mm	0.25	-	50	2,50€
54002	38x1,25mm	0.30	-	50	3,00€

1000 PCS

CONJUNTO DE GRAMPOS SEM CABEÇA

REF.	mm				€
54008	25x6mm	0.45	-	40	3,50€
54010	32x6mm	0.55	-	40	4,50€
54011	38x6mm	0.65	-	40	5,00€

1000 PCS



60028
60049C

15014

20,00€



M14 115-230 mm

PORCA DE REMOÇÃO RÁPIDA M14 PARA REBARBADORA



FERRAMENTAS ELÉTRICAS SEM FIO

PARA METAL

REF.	PARA	DESCRIÇÃO					€
14893	60008	T42 - 115x2,5mm	0.05	50	100	-	2,00€
14894	60028	T42 - 125x2,5mm	0.05	50	200	-	1,20€
14895	60008	T27 - 115x6mm	0.15	25	100	-	1,90€
14896	60028	T27 - 125x6mm	0.78	25	100	-	2,10€

PARA AÇO INOXIDÁVEL

REF.	PARA	DESCRIÇÃO					€
14897	60008	T41 - 115x1mm	0.01	50	400	-	0,88€
14898	60028	T41 - 125x1mm	0.03	50	400	-	0,98€
14899	60008	T41 - 115x1,6mm	0.03	50	400	-	0,88€
14900	60028	T41 - 125x1,6mm	0.04	50	400	-	0,98€



14893

T27	80 m/s	13300 RPM
	Ø115mm	Ø22,23mm



14894

T42	80 m/s	12200 RPM
	Ø125mm	Ø22,23mm



14897

T41	80 m/s	13300 RPM
	Ø115mm	Ø22,23mm



14898

T41	80 m/s	12200 RPM
	Ø125mm	Ø22,23mm



14895

T42	80 m/s	13300 RPM
	Ø115mm	Ø22,23mm



14896

T27	80 m/s	12200 RPM
	Ø125mm	Ø22,23mm



14899

T41	80 m/s	13300 RPM
	Ø115mm	Ø22,23mm



14900

T41	80 m/s	12200 RPM
	Ø125mm	Ø22,23mm



PARA METAL (AÇO INOXIDÁVEL, ALUMÍNIO, COBRE)

REF.	PARA	DESCRIÇÃO					€
14988	60007	24T 165mm	0.25	20	40	2400	8,00€
14989	60011	24T 115mm	0.10	20	100	3600	6,00€
14990	60022	40T 185mm	0.30	20	40	2200	10,50€
14993	60010	T118A	0.05	20	200	7200	5,00€
14995	60019	150mm 24TPI	0.05	20	200	8400	8,00€

PARA MADEIRA

REF.	PARA	DESCRIÇÃO					€
14985	60007	24T 165mm	0.25	20	40	2400	6,00€
14986	60011	24T 115mm	0.10	20	100	3600	4,00€
14987	60022	40T 185mm	0.30	20	40	2200	8,50€
14991	60010	T244D	0.05	20	200	7200	2,00€
14994	60019	150mm 6TPI	0.05	20	200	8400	3,50€



14989

	x24	7000 RPM
	Ø115mm	Ø10mm



14988

	x24	7000 RPM
	Ø165mm	Ø20mm



14990

	x40	7000 RPM
	Ø185mm	Ø25,4mm



14955

	24TPI	10mm CORTE PARA MADEIRA
	150mm	



14994

	6TPI	150mm CORTE PARA MADEIRA
	150mm	



14991

	T244D	100mm CORTE PARA MADEIRA
	100mm	



14993

	T118A	8mm CORTE PARA MADEIRA
	76mm	



14986

	x24	7000 RPM
	Ø115mm	Ø10mm



14985

	x24	7000 RPM
	Ø165mm	Ø20mm



14987

	x40	7000 RPM
	Ø185mm	Ø25,4mm

LUZES

- 130 LÂMPADAS DE INSPEÇÃO
- 132 LANTERNAS DE CABEÇA
- 134 GAMBIARRAS
- 135 FOCOS LED
- 136 ILUMINAÇÃO DE CAPÔ
- 137 PIRILAMPOS
- 139 LÂMPADA DE TRABALHO
- 142 SINALIZAÇÃO
- 144 ACESSÓRIOS E PEÇAS DE REPOSIÇÃO

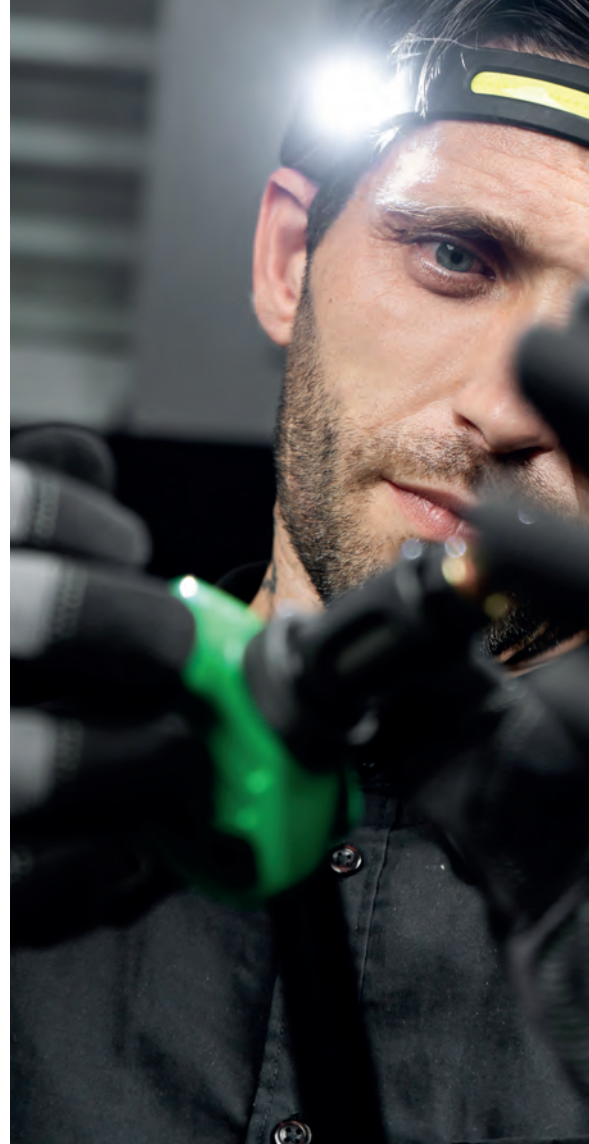

53734

23,70€

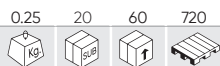

LANTERNA DE TRABALHO - 400LM



BASE ROTATIVA MAGNETIZADA 360° SELETOR DE INTENSIDADE DE LUZ CARREGADOR USB COM CABIDE

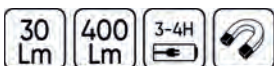

LED COB 400Lm - 2,5H LED COB 30Lm - 10H LI-ION 3.7V 2.600mah



EM EXPOSITOR DE 20 UDS



380mm 32mm

53519

42,00€

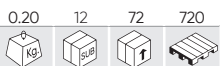

300mm 38mm 12mm

LANTERNA DE TRABALHO COB EXTRAFINO



150Lm - 4H 300Lm - 2H

LI-POLI 3.7V 800mA LED 3W COB

100V 240V 50-60 Hz 6500± 400 KELVIN

IP 44 68-71 ICR 5V 0.6A



EM EXPOSITOR DE 12 UDS

52536

57,00€

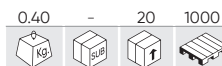

360mm 50mm

LANTERNA DE TRABALHO EXTRAPLANA COM LED COB RECARGABLE



INTENSITY 1 3H INTENSITY 2 4H

LITHIUM 3.7V 1.900mA LED 2W COB



DISEÑO REGISTRADO REGISTERED DESIGN



51889

49,00€

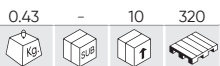

255mm 56mm

LANTERNA DE TRABALHO 24+6 COM IMAN DUPLO TRASEIRO, CUNHA DE APOIO E BASE IMANTADA



80Lm - 5H LED 24+6 LITHIUM 3.7V 2200mah



53216

49,00€

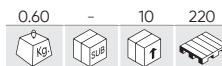

390mm 100mm

LANTERNA DE TRABALHO COB COM BASE FLEXÍVEL



170Lm - 4H LED 2W COB

LITHIUM 3.7V 2.000mA LITHIUM 5V 1000mA



GAMBIARRA COM BASE MAGNÉTICA ARTICULADA

54122 38,00€

0.39 12 24 384

300 Lm 3-4H

LED 3W - 7H COB 3W - 2,5H

LITHIUM 3.7V 2.000mA 6500± 400 KELVIN

IP 44 68-71 ICR 100V 240V 5V 1A

54123 40,00€

0.39 12 24 384

500 Lm 6-7H

LED 3W - 14H COB 5W - 3H

LITHIUM 3.7V 4.000mA 6500± 400 KELVIN

IP 44 68-71 ICR 100V 240V 5V 1A

54124 47,00€

0.39 12 24 384

1000 Lm 6-8H

LED 3W - 14H COB 10W - 3H

LM 1000 900 700
5min 30min 145min

LITHIUM 3.7V 4.000mA 6500± 400 KELVIN

IP 44 68-71 ICR 100V 240V 5V 1A



EM EXPOSITOR DE 12 UDS

REF. DESCRIÇÃO

14031 ADAPTADOR USB PARA TOMADA DE PAREDE

0.10 10 100 1152 7,90€

54379 28,00€

0.23 12 48 1440

140mm 73mm 20mm

LÂMPADA DE TRABALHO RECARREGÁVEL COB 10 W, ENERGIA SOLAR

80-800 Lm 5,2V 0,5W

3,5H 4-12H BANCO DE ENERGIA POWER BANK

80Lm 3W COB 800Lm 10W COB

x1 LI-POLI 3.7V - 4000mAh

LOW MEDIUM HIGH RED/RED STROBE

EM EXPOSITOR DE 12 UDS

53776 19,10€

0.15 12 48 1872

150mm 40mm 23mm

LANTERNA DE TRABALHO DE BOLSO COM BATERIA

90 Lm 300 Lm 2,5H

300Lm 5W COB - 3H LI-ION 3.7V 1500mah

250Lm 3W COB - 3,5H ABS TPR

90Lm 3W LED - 6H

EM EXPOSITOR DE 12 UDS

250LM 3W COB 300LM 5W COB 90LM 3W LED

LUZES

54344

10,50€

0,10	10	100	1200

CAPACETE COM LANTERNA LED

120 Lm	60 Lm	25 Lm
--------	-------	-------

LM 120	60	25
40min	6-8h	8-10h

3.7V 250mAh	2H
-------------	----

LUZ DISPERSA SCATTERED LIGHT	1W
---------------------------------	----



UNIDADE DE LUZ AMOVÍVEL

POLIÉSTER (65%)
ACRÍLICO (35%)



N

52987

20,00€

0,17	10	40	720

LANTERNA DE TRABALHO DE BOLSO COM BATERIA

120 Lm	2,5H
--------	------

120Lm - 2,5H	
--------------	--

LITHIUM 3.7V 1.000mAh	LED 3W COB
--------------------------	---------------



EM EXPOSITOR DE 10 UDS



160mm	30mm	20mm
-------	------	------



53780

14,50€

0,45	5	20	300

LUZ DE TRABALHO LED 400LM

400 Lm	6W	220V 240V
--------	----	--------------

IP 20	50 Hz
-------	-------

6000± 7000 KELVIN

H05RN-F 2x0.75mm ² - 5m

CABO DE ALIMENTAÇÃO DE 2,5M



52384

29,00€

0,33	-	20	600

LANTERNA DE TRABALHO EXTRAPLANA COM LED COB

- Comp. cabo: 5m
- DC Comp. cabo: 0,1m
- DC Comp. do cabo até às pinças: 0,3m

200 Lm	12V 24V
--------	------------

LED 3W COB

75mm	325mm	90mm
------	-------	------



53217

47,00€

0,30	-	20	620

LANTERNA DE TRABALHO PORTÁTIL COB

200 Lm	4H	LED 2W COB		LITHIUM 3.7V 2.200mah	LITHIUM 5V 1.000mah
--------	----	---------------	--	--------------------------	------------------------



45mm	380mm
------	-------

54004

16,00€

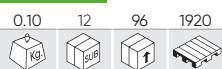

LANTERNA LED DE CABEÇA COB

COB 350Lm -5W COB	LED 90Lm -3W XPE
COB 350Lm - 2,5H 150Lm - 5 H Flash - 8 H	LED XPE 150Lm - 4H 60Lm - 8 H
LI-ION 3.7V 1.200mA	Gel de sílice Silica gel
2m	IP X4



BOTÃO DO SENSOR DE MOVIMENTO

Pressione para ativar.
Pressione para desativar.
Passe a mão na frente do botão para acender e apagar a luz.

- Material: sílica gel
- Indicador de energia, indicador de indução
- Modo de ativação do sensor de movimento
- Cabo de carregamento USB incluído



EM EXPOSITOR DE 12 UDS

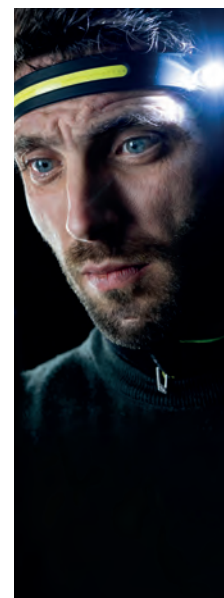

53569

18,00€



LANTERNA DE CABEÇA 800 LM (COB + CREE)

- REGULADOR DE FOCO
- 3 MODOS DE LUZ
- BATERIAS RECARREGÁVEIS
- INDICADOR LUMINOSO ACESO



MAX 800 Lm	2,5H	150m
LED COB + CREE	x2 18650	
High Low Flash COB		



53568

12,00€

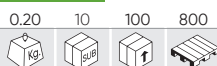

LANTERNA DE CABEÇA 350 LM

- REGULADOR DE FOCO
- 3 MODOS DE LUZ

MAX 350 Lm	2,5H	150m
High Low Flash SOS		
LI-ION 2000mAh		



54267

9,50€

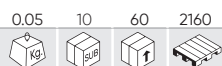

LUVA COM LUZ LED

70 Lm	120 mAh	+20H
LED	DERECHA RIGHT	
x2 CR2016 INCLUIDAS / INCLUDED		
x2 LED 3.0V		



53974

38,00€

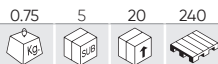

FOCO AUXILIAR RECARREGÁVEL

1500 Lm

5-6H 100% 50%

2.5H 6H

LED 20W COB ABS

100% SOS 50% FLASH

4 MODOS DE ILUMINAÇÃO
100% 50% SOS FLASH



MULTIPOSIÇÃO

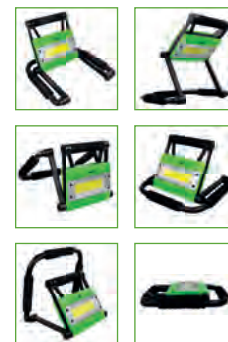

52555

2,38€

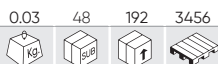

LANTERNA PLÁSTICA 9 LEDS



27 Lm x9 LED x3 AAA

30mm 93mm

EM EXPOSITOR DE 12 UDS

52558

2,38€

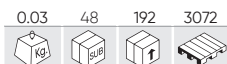

51326

4,40€

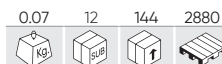

LANTERNA DE 21 LEDS



63 Lm x21 LED x3 AAA

95mm 35mm

EM EXPOSITOR DE 12 UDS

PILHAS DE RECAMBIO

REF.	DESCRIÇÃO	0.01	60	2400	134400	€
51258	"AAA" R03 1,5V					0,15€

PARA REF. 51326, 52233, 52555, 52558

REF.	DESCRIÇÃO	0.05	10	500	€
10923	9V				1,10€

PARA REF. 52162, 52450, 51929, 50942



53427

5,00€

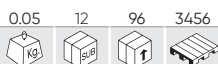

LANTERNA DE 6 LEDS IMANTADA



EM EXPOSITOR DE 12 UDS

45 Lm x6 LED x3 AAA



51573

2,50€



LANTERNA DE DINAMO DE 2 LEDS



6 Lm x2 LED

APRESENTAÇÃO CAIXA INDIVIDUAL



53227

28,00€

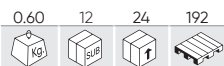

LUPA LED DE MESA

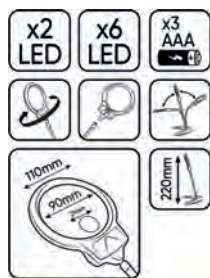

53085

30,00€

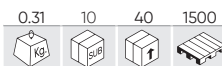

LUPA 8 LED

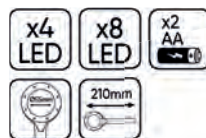

TRIPÉ PARA FOCO LED

REF.	Max.	Min.	kg	box	pallet	€
53506	1830mm	840mm	2.40	-	8	36,00€
52254	2770mm	1290mm	3.51	-	4	64,00€



53505

77,00€



FOCO LED DE 50W



54039

154,00€

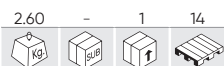

LÂMPADA LED INDUSTRIAL

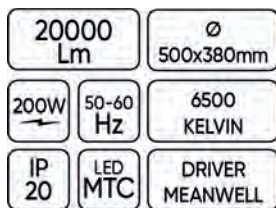

54133

547,00€



CONJUNTO DE 6 LÂMPADAS INDUSTRIAIS LED 54039

6 PCS



REF. DESCRIÇÃO

15385 CAPA DE REPOSIÇÃO PARA REF. 54039

kg	box	pallet	€
0.15	6	60	18,00€

54088

132,00€



LÂMPADA LED INDUSTRIAL



LUZES

54270

42,00€



LÂMPADA LED COM SUPORTE MAGNÉTICO

1000 Lm | 3-4H |

LED 1000Lm- 2H | LED 400Lm- 5H

x2 LI-ION 3.7V - 1200mAh | USB TYPE-C



54271

54,00€

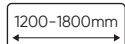
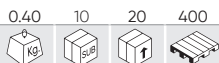

BARRA LED MAGNÉTICA COM CORREIA PARA O CAPÔ

1000 Lm | 3-4H |

LED 1000Lm- 2H | LED 400Lm- 5H

x2 LI-ION 3.7V - 1200mAh | USB TYPE-C



ARTICULADO

53707

153,00€



LÂMPADA LED COM SUPORTE MAGNÉTICO

1000 Lm | |

7-8H | 6H | ABS

LED 3x5W COB | 350Lm | 700Lm | 1000Lm

x4 LI-ION 3.7V - 2600mAh



3 MODOS DE LUZ
 BATERIA RECARREGÁVEL
 LUZES INDICADORAS DO ESTADO DA BATERIA

AUMENTAR SIGNIFICATIVAMENTE A VISIBILIDADE NA ÁREA DE TRABALHO
 PERMITE DIRECIONAR O FOCO DE LUZ INDIVIDUALMENTE DONDE SEJA NECESSÁRIO
 COM SUPORTE MAGNÉTICO PARA DE ADAPTAR A QUALQUER SITUAÇÃO



53570

154,00€



LÂMPADA DE INSPEÇÃO DA COBERTURA DO MOTOR

1000 Lm | |

7-8H | 6H

LED 3x5W COB | 400Lm | 800Lm | 1200Lm

x4 LI-ION 3.7V - 2600mAh



3 MODOS DE LUZ
 BATERIA RECARREGÁVEL
 LUZES INDICADORAS DO ESTADO DA BATERIA

AUMENTAR SIGNIFICATIVAMENTE A VISIBILIDADE NA ÁREA DE TRABALHO
 PERMITE DIRECIONAR O FOCO DE LUZ INDIVIDUALMENTE DONDE SEJA NECESSÁRIO



54173 87,00€

0.75 5 20 240

LUZ DE EMERGÊNCIA LED RECARREGÁVEL COM BASE MAGNÉTICA

- FUNÇÕES:
FUNÇÃO 1: FLASCH
FUNÇÃO 2: DUPLO
FUNÇÃO 3: ROTAÇÃO

20W 5V x45 LED

PC ABS 2-3H 2-3H

LI-ION 7.4V - 2200mA -30°C 50°C IP 65



REF. DESCRIÇÃO €

16053 CABO USB TIPO A / JACK REDONDO 5.5MM 0.05 10 100 2,85€

54172 81,00€

0.80 5 20 240

LUZ DE EMERGÊNCIA RECARREGÁVEL COM BASE FLEXÍVEL

- FUNÇÕES:
FUNÇÃO 1: FLASCH
FUNÇÃO 2: DUPLO
FUNÇÃO 3: ROTAÇÃO

20W 5V x45 LED

PC ABS 2-3H 2-3H

LI-ION 7.4V - 2200mA -30°C 50°C IP 65



REF. DESCRIÇÃO €

16052 CABO USB TIPO A / JACK REDONDO 3.5MM 0.05 10 100 2,09€

53691 36,00€

0.70 - 20 320

LUZ DE EMERGÊNCIA LED MAGNÉTICO

- FUNÇÕES:
FUNÇÃO 1: FLASCH
FUNÇÃO 2: DUPLO
FUNÇÃO 3: ROTAÇÃO



x8 LED 18W 12V 24V IP 66

112mm 125cm -30°C 50°C

4m PC ECE R10 ECE R65



53690 34,00€

0.55 - 20 200

LUZ DE EMERGÊNCIA LED 12-24V BASE FLEXÍVEL

- FUNÇÕES:
FUNÇÃO 1: FLASCH
FUNÇÃO 2: DUPLO
FUNÇÃO 3: ROTAÇÃO



x8 LED 18W 12V 24V IP 66

182mm 125cm -30°C 50°C

PC ECE R10 ECE R65



52375 38,00€

0.70 - 20 240

170mm Ø140mm

LUZ DE EMERGÊNCIA LED 12-24V - MÓDULO P/PISCAR LED

- LENTE ABS-BAES.
- TULIPA ANTI-ROTURA.
- CABO: ASPIRAL DE 2,5M +TOMADA DE ISQUEIRO.
- CONSUMO: 9W.

- FUNÇÕES:
FUNÇÃO 1: ROTAÇÃO
FUNÇÃO 2: DUPLO FLASH
FUNÇÃO 3: 6 FLASH

12V 24V 9W

170mm Ø 140cm IP 56

2,5m PC/ABS ECE R10



BASE MAGNÉTICA

52456 36,00€

0.60 - 20 160

240mm Ø128mm

LUZ DE EMERGÊNCIA LED 12-24V BASE FLEXÍVEL

- LENTE PC.
- TULIPA ANTI-ROTURA.
- CONSUMO: 8W.

- FUNÇÕES:
FUNÇÃO 1: ROTAÇÃO
FUNÇÃO 2: DUPLO FLASH
FUNÇÃO 3: 6 FLASH

12V 24V 8W PC/ABS

240mm Ø 128cm IP 56



BASE FLEXÍVEL

LUZES

51964

28,00€



LUZ DE EMERGÊNCIA C/BASE FLEXÍVEL H1 12V 55W

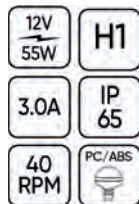

Cúpula anti-chock
Lente: PC
Fio da lente com soldadura de durabilidade
Rpm: 40
Sistema de pinhão / Senfim
Lâmpada H1, 12V 55W
Com base de rosca
Consumo de corrente: 3.0Amp



ABS - BAES
BASE FLEXÍVEL

51965

29,50€



LUZ DE EMERGÊNCIA COM BASE FLEXÍVEL H1 24V 70W



Cúpula anti-chock
Lente: PC
Fio da lente com soldadura de durabilidade
Rpm: 40
Sistema de pinhão / Senfim
Lâmpada H1, 24V 70W
Com base de rosca
Consumo de corrente: 3.0Amp



ABS - BAES
BASE FLEXÍVEL

51962

25,00€

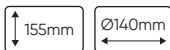

LUZ DE EMERGÊNCIA SEM CABO H1 12V 55W



Cúpula anti-chock
Lente ABS - BAES
Fio de lente com soldadura de durabilidade
Rpm : 40
Sistema de pinhão / Senfim
Lâmpada H1, 12V 55W
Consumo de corrente : 3.0 Amp



51963

29,00€



LUZ DE EMERGÊNCIA SEM CABO H1 24V 70W



Cúpula anti-chock
Lente ABS - BAES
Fio de lente com soldadura de durabilidade
Rpm : 40
Sistema de pinhão / Senfim
Lâmpada H1, 24V 70W
Consumo de corrente : 3.0 Amp



51960

34,00€



LUZ DE EMERGÊNCIA LED COM CABO MAGNÉTICO H1 12V-55W



Cúpula anti-shock
Lente ABS - BAES
Filo da lente com soldadura de durabilidade
Rpm : 40
Sistema de pinhão / Senfim
Lâmpada H1, 12V 55W
Cabo :
Aspiral de 4 m com tomada de isqueiro
Consumo corrente : 3.0 Amp



51961

34,00€



LUZ DE EMERGÊNCIA COM CABO COM IMÁN H1 24V 70W



Cúpula anti-shock
Lente ABS - BAES
Filo da lente com soldadura de durabilidade
Rpm : 40
Sistema de pinhão / Senfim
Lâmpada H1, 24V 70W
Cabo :
Aspiral de 4 m com tomada de isqueiro
Consumo corrente : 3.0 Amp



LUZ DE EMERGÊNCIA TIPO FLASH DE LEDS

REF.					€
52827		0.50	-	20	400 46,00€
52828		0.54	-	20	320 43,00€
52910		0.50	-	20	320 39,00€

- COM 3 INTERRUPTORES DE FUNÇÃO.
- 3 MODOS PISCAR:
ROTAÇÃO
6 FLASHS
DUPLO FLASH



51966

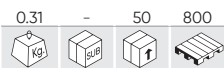

18,00€

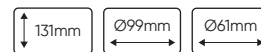

LUZ DE EMERGÊNCIA TIPO FLASH 12V-110V



- Lente ABS - BAES.
- XÉNON.
- Consumo de corrente: 3.0 A.



BASE TULIPA ROSCADA

ACESSÓRIOS PARA ARMARIOS

REF.	DESCRIÇÃO					€
11103	LÂMPADA DE RECAMBIO PARA REF. 51966	0.01	-	100	-	6,00€
10766	LÂMPADA DE RECAMBIO PARA REF.51962, 51962	0.01	-	200	-	1,59€
10750	CONECTOR PARA LUZ DE EMERGÊNCIA REF. 51964, 51965, 52456	0.25	-	50	-	13,00€
10751	CONECTOR PARA LUZ DE EMERGÊNCIA REF. 51964, 51965, 52300 E 52456	0.30	-	50	-	15,00€
52843	CABO EXTENSÍVEL MULTIFUNÇÃO	0.90	-	20	1500	31,60€
51969	CÚPULA DE LUZ DE EMERGÊNCIA LARANJA PARA REF. 51960, 51961, 51964	0.12	-	50	1000	14,00€
11324	CÚPULA AZUL DE LUZ DE EMERGÊNCIA PARA REF. 51960, 51961, 51964	0.13	-	100	-	17,50€
11325	CÚPULA DE LUZ DE EMERGÊNCIA ROJO PARA REF. 51960, 51961, 51964	0.12	-	50	451	17,50€



FOCO AUXILIAR LED LUZ DISPERSA

53428

18,00€

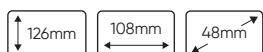
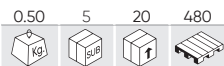

53429

18,00€

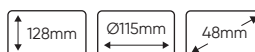
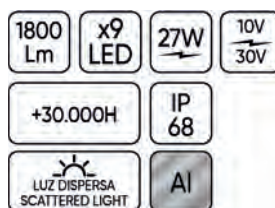
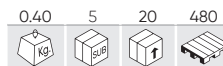

LUZES

52566

28,00€

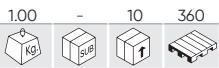

1450 Lm x9 LED 27W 10V/40V
 +30.000H IP 68
 LUZ DISPERSA SCATTERED LIGHT AI



52567

29,00€

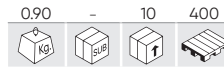

1450 Lm x9 LED 27W 10V/40V
 +30.000H IP 68
 LUZ DISPERSA SCATTERED LIGHT AI

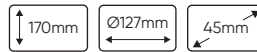

52302

25,40€

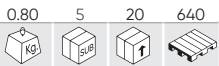

1450 Lm x9 LED 27W 10V/40V
 +30.000H IP 68
 LUZ DISPERSA SCATTERED LIGHT AI

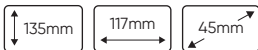

52303

26,40€

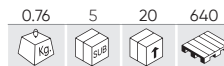

1450 Lm x9 LED 27W 10V/40V
 +30.000H IP 68
 LUZ DISPERSA SCATTERED LIGHT AI

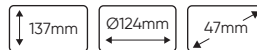

53049

89,00€

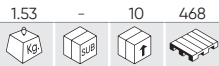

3600 Lm x4 LED 40W 9V/36V
 +30.000H IP 68
 LUZ DISPERSA SCATTERED LIGHT AI

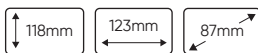

53052

158,00€

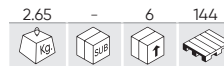

7200 Lm x8 LED 80W 9V/36V
 +30.000H IP 68
 LUZ DISPERSA SCATTERED LIGHT AI

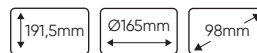

53045

35,00€

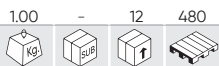

2800 Lm x16 LED 48W 10V/40V
 +20.000H IP 67
 LUZ DISPERSA SCATTERED LIGHT AI

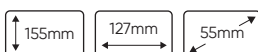

53046

39,00€

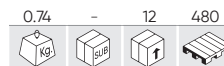

2272 Lm x16 LED 24W 9V/36V
 +20.000H IP 68
 LUZ DISPERSA SCATTERED LIGHT AI



FOCO AUXILIAR LED LUZ CONCENTRADA

52568 28,00€

0.75 - 10 400



1450 Lm x9 LED 27W 10V/30V

+30.000H IP 68

LUZ CONCENTRADA SPOTLIGHT AI



165mm 117mm 45mm

52569 28,00€

0.70 5 20 320



1450 Lm x9 LED 27W 10V/30V

+30.000H IP 68

LUZ CONCENTRADA SPOTLIGHT AI



170mm Ø127mm 45mm

53048 89,00€

1.50 - 10 1000



3600 Lm x4 LED 40W 9V/36V

+30.000H IP 68

LUZ CONCENTRADA SPOTLIGHT AI



118mm 123mm 87mm

53051 158,00€

2.75 - 6 468



7200 Lm x8 LED 80W 9V/36V

+30.000H IP 68

LUZ CONCENTRADA SPOTLIGHT AI



191,5mm Ø165mm 98mm

52415 19,00€

0.60 5 20 640



1450 Lm x9 LED 27W 10V/40V

+30.000H IP 68

LUZ CONCENTRADA SPOTLIGHT AI



127mm 110mm 50mm

52414 19,00€

0.55 5 20 600



1450 Lm x9 LED 27W 10V/40V

+30.000H IP 68

LUZ CONCENTRADA SPOTLIGHT AI



127mm Ø110mm 55mm

53047 330,00€

3.51 - 4 40



3200 Lm x10 LED 50W 12V/24V

6500 KELVIN 280cm IP 67

LUZ CONCENTRADA SPOTLIGHT AI

GIRATÓRIO

VELOCIDADE AJUSTÁVEL DE MOVIMENTO

DISTÂNCIA REMOTA 100M





230mm 185mm 150mm

LUZES

54161

90,00€



BARRA DE SINALIZAÇÃO PARA REBOQUES DE 1,4 A 2.1M

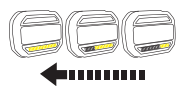

REGULAMENTO	HOMOLOGAÇÃO
3	E9*3R02/17*23444*00
4	E9*4R00/19*23444*00
6	E9*6R01/29*23444*00
7	E9*7R02/27*23444*00
10	E9*10R06/00*22232*02

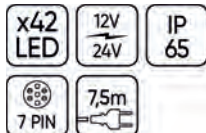

54163

80,00€



BARRA DE SINALIZAÇÃO PARA REBOQUE DE 1.100X140MM COM 2 SINALIZADORES LED E 2 TRIÂNGULOS REFLETORES



REGULAMENTO	HOMOLOGAÇÃO
3	E9*3R02/17*23444*00
4	E9*4R00/19*23444*00
6	E9*6R01/29*23444*00
7	E9*7R02/27*23444*00
10	E9*10R06/00*22232*02

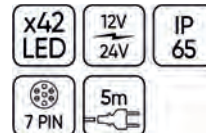

50910

45,00€



BARRA DE SINALIZAÇÃO PARA REBOQUE DE 1100X140MM COM 2 FAROLINS, 2 TRIÂNGULOS REFLECTORES



REGULAMENTO	HOMOLOGAÇÃO
4	E4*4R-0024080
6	E4*6R-0124080
7	E4*7R-0224080
10	E9*10R06/02*23498*00



52838

56,00€

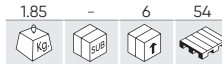

BARRA DE SINALIZAÇÃO PARA REBOQUE DE 1.100X140MM COM 2 FAROLINS LED, 2 TRIÂNGULOS



HOMOLOGAÇÃO
E4*7R-0218756



KIT MAGNÉTICO COM 2 SINALIZADORES LED E 2 TRIÂNGULOS REFLECTORES

CABO LISO: 7,5M
CABO ESPIRAL: 2,5M

54162

81,00€



HOMOLOGAÇÃO
E9*7R02/27*23444*00



51886

44,00€



REGULAMENTO	HOMOLOGAÇÃO
3	E4*3R-023749
4	E4*4R-0024080
6	E4*6R-0124080
7	E4*7R-0224080
10	E9*10R06/02*23498*00

52839

64,00€

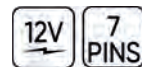
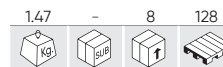

REGULAMENTO	HOMOLOGAÇÃO
3	E4*3R-0218756
4	E4*4R-0018756
6	E4*6R-0118756
7	E4*7R-0218756
10	E9*10R06/02*23199*01

54044 99,00€

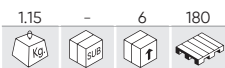

CONJUNTO DE DUAS LUZES TRASEIRAS MAGNÉTICAS SEM FIO



HOMOLOGAÇÃO

E9*10R05/01*16210*02

53151 14,00€

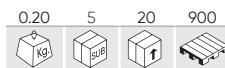

SINALIZADOR LED PARA BARRA DE REBOQUE



- 4 funções:
- Azul: Posição e matrícula.
- Vermelho: luz de freio.
- Amarelo: Parpadeante.
- Branco: Massa.

SINALIZADOR LED PARA BARRA DE REBOQUE

REF.		0.20	5	20	€
54160L	ESQUERDO	0.20	5	20	17,50€
54160R	DIREITO	0.20	5	20	17,50€

- 4 funções:
- Preto: Posição e matrícula.
- Vermelho: luz de freio.
- Verde: Parpadeante.
- Branco: Massa.

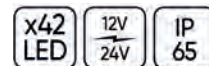

HOMOLOGAÇÃO

E9*7R02/27*23444*00
E9*10R06/01*23199*00



53536 34,00€

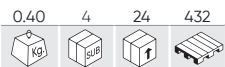

COMPROVADOR DE LUZES DE REBOQUE 7/13 PINOS



REF. DESCRIÇÃO

REF.	DESCRIÇÃO	0.20	-	50	-	13,00€
14753	EXTENSÃO DE 7 PINOS PARA REF. 53536	0.20	-	50	-	13,00€

51929 22,00€

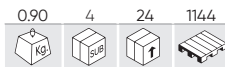

COMPROVADOR DE LUZES DE REBOQUE 7 PINOS



TOMADA REBOQUE

TOMADA VEÍCULO

LUZES

SIRENA ACÚSTICO 12V-80V

REF.	DB	IP	V	°C				€
51967	97DB	IP65	12V-80V	-30/70°C	0.20	50	1200	16,00€
51968	107DB	IP65	12V-80V	-30/70°C	0.23	50	1000	16,00€



- Resistente a diversas condições climáticas.
- Possibilidade de ser lavado com água a pressão.
- Protegido frente a polaridades inversas.
- Soldado com resinas ipoxy.



51967



51968

54078



68,00€

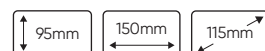

LUZ DE SEGURANÇA PARA EMPILHADEIRA



Luz de segurança oval com 2 LEDs azuis. A luz é projetada no solo com uma luz azul direcional como um aviso para pedestres na área. Esta luz de aviso permite evitar colisões e acidentes entre empilhadores e pessoas, e aumenta a segurança em condições de trabalho, especialmente em pontos cegos. Perfeito para ambientes ruidosos.



CARREGADOR DE ISQUEIRO E TOMADA CORRENTE

REF.	DESCRIÇÃO					€
10961	TOMA DE CORRENTE PARA REF. 51889 E 52257	0.08	-	50	-	13,00€
11107	CARREGADOR ISQUEIRO PARA REF. 51889	0.06	-	250	-	4,50€
11989	CARREGADOR ISQUEIRO PARA GAMBIARRA COM REF. 52536	0.04	-	200	-	2,00€
13839	ADAPTADOR DE TOMADA USB 110V/60HZ	0.04	-	200	-	8,50€
14031	ADAPTADOR USB PARA TOMADA DE PAREDE	0.10	10	100	1152	7,90€
14032	ADAPTADOR USB PARA TOMADA DE ISQUEIRO	0.10	10	100	1200	12,00€
14033	CABO USB TIPO A / MICRO-B	0.10	10	100	500	4,50€
16052	CABO USB TIPO A / JACK REDONDO 3.5MM	0.05	10	100	-	2,09€
16053	CABO USB TIPO A / JACK REDONDO 5.5MM	0.05	10	100	-	2,85€



10961



11107



11989



13839



14031



14032



14033



16052

16053

FERRAMENTAS PNEUMÁTICAS

- 147 APARAFUSAR
- 151 PERFURAR
- 152 CORTAR / SERRAR
- 153 LIXAR/POLIR
- 156 PISTOLAS DE AR
- 158 MANUTENÇÃO DE PNEUS
- 160 OUTROS
- 163 ENROLADORES DE MANGUEIRAS DE AR
- 165 MANGUEIRAS CONECTORES
- 166 ACESSÓRIOS E CONSUMÍVEIS



JBM RECOMENDA O USO DE SEUS ÓLEOS LUBRIFICANTES PARA OTIMIZAR O DESEMPENHO E AMPLIAR A VIDA ÚTIL DA FERRAMENTA

REF.14534 REF.14560

PÁGINA 161



53520

228,00€

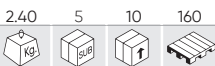

CHAVE DE IMPACTO 1/2" (1756NM) - COMPOSITE



COMPOSITE

1756Nm

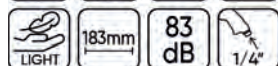

REF. DESCRIÇÃO

14121 KIT DE REPARAÇÃO DE FERRAMENTAS PNEUMÁTICAS - 51207 / 53520

0.75 - 20 26,00€

51207

289,00€



CONJUNTO DE CHAVE DE IMPACTO COMPOSTA DE 1/2" + SOQUETES



COMPOSITE

1756Nm



REF. DESCRIÇÃO

14121 KIT DE REPARAÇÃO DE FERRAMENTAS PNEUMÁTICAS - 51207 / 53520

0.75 - 20 26,00€

51206

228,00€

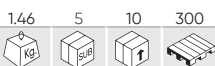

CHAVE DE IMPACTO 1/2" MINI COMPOSITE



COMPOSITE

1302Nm



REF. DESCRIÇÃO

14120 KIT DE REPARAÇÃO DE FERRAMENTAS PNEUMÁTICAS - 51206

0.15 - 5 22,00€

53588

178,00€



CHAVE DE IMPACTO MODELO NANO 1/2" (1302NM)



1302Nm



REF. DESCRIÇÃO

14165 KIT DE REPARAÇÃO DE FERRAMENTAS PNEUMÁTICAS - 53588

0.05 - 20 26,50€

JBM RECOMENDA O USO DE SEUS ÓLEOS LUBRIFICANTES PARA OTIMIZAR O DESEMPENHO E AMPLIAR A VIDA ÚTIL DA FERRAMENTA

REF.14534 REF.14560

PÁGINA 161



53733 238,00€

1.30 5 10 280

CHAVE PNEUMÁTICA ANGULAR DE IMPACTO DE 1/2"



650Nm

8500 RPM	8500 RPM	8500 RPM	X4 SPEED
MAX 650 NM	27-231 Nm	1/2"	1/4"
113 L/min	90PSI 4CFM	LIGHT	88mm

REF.	DESCRIÇÃO	1.30	5	10	€
14633	KIT DE REPARAÇÃO DE FERRAMENTAS PNEUMÁTICAS - 53733	0.03	-	20	22,50€

54340 296,00€

1.30 - 5 -

PISTOLA DE IMPACTO ARTICULADA 1/2"



813 Nm

8000 RPM	MAX 813 NM	1/2"
1/4"	210 L/min	X6 SPEED
90 PSI	8 CFM	6,2 BAR

REF.	DESCRIÇÃO	1.30	5	€
16341	KIT DE REPARAÇÃO DE FERRAMENTAS PNEUMÁTICAS - 54340	0.07	-	15 32,50€

54397 249,00€

1.30 5 10 -

CHAVE DE IMPACTO PNEUMÁTICA DE 1/2"



1004Nm

7500 RPM	MAX 1004 NM	1/2"	1/4"
6.3 BAR	90 PSI	8.4 CFM	764(m/s²)
92,9 dB(Lp)	103,9 dB(Lw)	96 L/min	

141mm 85mm 64mm

REF.	DESCRIÇÃO	1.30	5	10	€
16564	KIT DE REPARAÇÃO DE FERRAMENTAS PNEUMÁTICAS - 54397	0.10	-	20	17,00€

53689 238,00€

2.10 5 10 160

CHAVE DE IMPACTO 1/2" (1950NM) - COMPOSITE



COMPOSITE 1950Nm

8600 RPM	MAX 1950 NM	95-936 Nm	1/2"
169mm	1/4"	X4 SPEED	90PSI 4CFM

REF.	DESCRIÇÃO	2.10	5	10	160	€
14618	KIT DE REPARAÇÃO DE FERRAMENTAS PNEUMÁTICAS - 53689	0.01	-	20		19,00€

FERRAMENTAS PNEUMÁTICAS

53608

98,00€

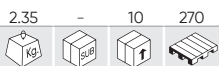

CHAVE DE IMPACTO 1/2" 1200NM

1200Nm

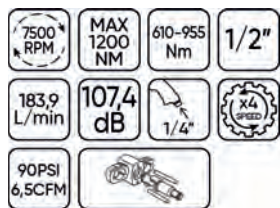

REF. DESCRIÇÃO



14583 KIT DE REPARAÇÃO DE FERRAMENTAS PNEUMÁTICAS - 53608 0.01 - 20 6,00€

53726

128,00€

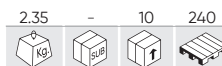

CHAVE DE IMPACTO 1/2" 1650NM

1650Nm

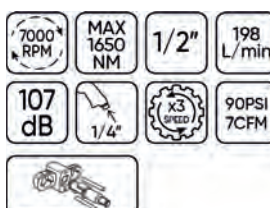

REF. DESCRIÇÃO



15564 KIT DE REPARAÇÃO DE FERRAMENTAS PNEUMÁTICAS - 53726 0.05 - - 11,90€

51212

488,00€



CHAVE DE IMPACTO 3/4" COMPOSITE

2034Nm

COMPOSITE

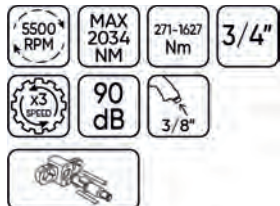

REF. DESCRIÇÃO



14122 KIT DE REPARAÇÃO DE FERRAMENTAS PNEUMÁTICAS - 51210 / 51212 1.12 - 50 34,00€

51211

560,00€



CHAVE DE IMPACTO 1" COMPOSITE

2034Nm

COMPOSITE

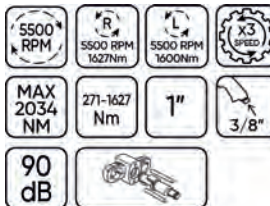

REF. DESCRIÇÃO



14123 KIT DE REPARAÇÃO DE FERRAMENTAS PNEUMÁTICAS - 51211 / 51213 1.16 - 20 33,00€

51210

650,00€



CHAVE DE IMPACTO DE 3/4" + ALARGADOR 15CM COMPOSITE

2034Nm

COMPOSITE

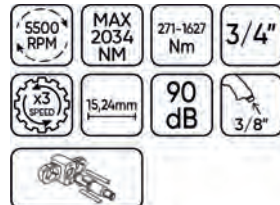

REF. DESCRIÇÃO



14122 KIT DE REPARAÇÃO DE FERRAMENTAS PNEUMÁTICAS - 51210 / 51212 1.12 - 50 34,00€

51213

690,00€



CHAVE DE IMPACTO 1" + ALARGADOR 19CM COMPOSITE

2034Nm

COMPOSITE

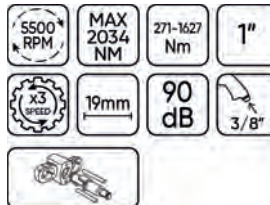

REF. DESCRIÇÃO



14123 KIT DE REPARAÇÃO DE FERRAMENTAS PNEUMÁTICAS - 51211 / 51213 1.16 - 20 33,00€

53681

743,00€

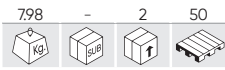

CHAVE DE IMPACTO PARA CAMINHÕES 1" - ULTRA LIGEIRA



2441Nm



REF.	DESCRIÇÃO	kg	Sub	U	€
14336	KIT DE REPARAÇÃO DE FERRAMENTAS PNEUMÁTICAS - 53681	1.17	10	10	58,00€

52814

528,00€

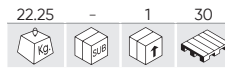

CHAVE DE IMPACTO PARA CAMINHÕES 1" 3260NM



3260Nm



REF.	DESCRIÇÃO	kg	Sub	U	€
14153	KIT DE REPARAÇÃO DE FERRAMENTAS PNEUMÁTICAS - 52814	0.05	-	15	20,50€

53343

285,00€

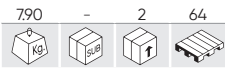

CHAVE DE IMPACTO 3/4"

1600Nm

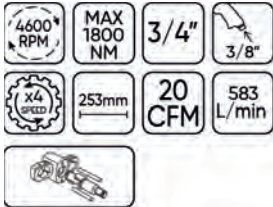

51222

128,00€



CHAVE DE IMPACTO 1/2" DOBLE BLISTER

101Nm



REF.	DESCRIÇÃO	kg	Sub	U	€
14131	KIT DE REPARAÇÃO DE FERRAMENTAS PNEUMÁTICAS - 51222	0.01	-	10	24,00€

52156

140,00€

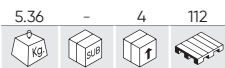

KIT DE 16 CHAVES PNEUMÁTICAS COM PISTOLA E ROQUETE



x10 9, 10, 11, 13, 14, 17, 19, 22, 24, 27mm

52165

118,00€

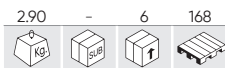

CHAVE DE IMPACTO DE 1/2"

680Nm



54336

259,00€



N

CATRACA PNEUMÁTICA ARTICULADA DE 1/2"

95Nm



REF. DESCRIÇÃO

16273 KIT DE REPARAÇÃO DE FERRAMENTAS PNEUMÁTICAS - 54336

0.15 - 15 12,50€

51214

148,00€

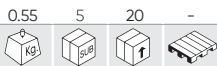

ROQUETE MINI DE 1/4" COMPOSITE

40,7Nm

COMPOSITE



REF. DESCRIÇÃO

14124 KIT DE REPARAÇÃO DE FERRAMENTAS PNEUMÁTICAS - 51214

0.25 - 10 20,50€

51215

119,00€

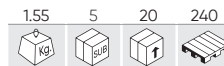

ROQUETE DE 1/2"

14-68Nm



REF. DESCRIÇÃO

14125 KIT DE REPARAÇÃO DE FERRAMENTAS PNEUMÁTICAS - 51215

0.03 - 10 19,50€

52167

48,00€

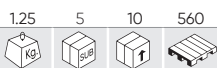

ROQUETE PNEUMÁTICO DE 1/2"

61Nm



53784

148,00€



ROQUETE MINI DE 1/2" COMPOSITE

40,8Nm

COMPOSITE



REF. DESCRIÇÃO

14779 KIT DE REPARAÇÃO DE FERRAMENTAS PNEUMÁTICAS - 53784

0.05 - 10 33,00€

51221 199,00€



BERBEQUIM ÂNGULO 90°



REF.	DESCRIÇÃO	kg	SUB	Q	€
14130	KIT DE REPARAÇÃO DE FERRAMENTAS PNEUMÁTICAS - 51221	0.40	-	10	21,00€

51220 240,00€



BERBEQUIM COMPOSITE



REF.	DESCRIÇÃO	kg	SUB	Q	€
14129	KIT DE REPARAÇÃO DE FERRAMENTAS PNEUMÁTICAS - 51220	0.01	-	10	12,50€

53573 36,00€



BERBEQUIM PNEUMÁTICO DIRETA



52159 64,00€



BERBEQUIM REVERSÍVEL PNEUMÁTICO DE 1/2"



52527 82,00€



BERBEQUIM 3/8" ÂNGULO 90°



52160 48,00€

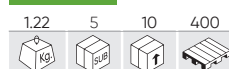

BERBEQUIM PNEUMÁTICO DE 3/8"



MÁQUINA PARA DESCRAVAR PONTOS SOLDADURA PNEUMÁTICA

52724 381,00€



REF.	DESCRIÇÃO	kg	SUB	Q	€
13817	PONTA DE 6,5MM PARA REF. 52725	0.10	-	500	17,00€

52725 349,00€



REF.	DESCRIÇÃO	kg	SUB	Q	€
13818	PONTA DE 8MM PARA REF. 52725	0.10	-	500	20,50€

52718

48,00€

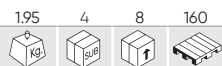

MARTILLO PNEUMÁTICO 9PCS



- A 21mm
- B 1,8mm
- C 21mm
- D 21mm



52953

38,00€

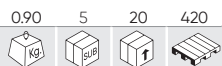

CORTADORA PNEUMÁTICA 3"



REF.	DESCRIÇÃO	kg	Sub	U	€
12987	DISCO DE CORTE PARA CORTADORA PNEUMÁTICA 3"	0.02	50	500	1,50€

53140

98,00€

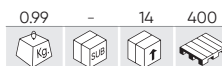

CORTADORA PNEUMÁTICA



REF.	DESCRIÇÃO	kg	Sub	U	€
14013	REFIL DE DISCO PARA REF. 53140	0.01	-	1000	3,50€

53541

168,00€

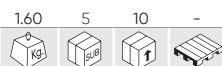

TESOURA PNEUMÁTICA METÁLICA



REF.	DESCRIÇÃO	kg	Sub	U	€
14136	KIT DE REPARAÇÃO DE FERRAMENTAS PNEUMÁTICAS - 53541	0.01	-	5	12,00€

52574

69,00€



SERRA PNEUMÁTICA



REF.	DESCRIÇÃO	kg	Sub	U	€
11956	5 LÂMINAS DE SERRA 24 DENTES	0.03	10	300	5,50€
11957	5 LÂMINAS DE SERRA 32 DENTES PARA FERRO	0.01	10	250	5,50€

51216

650,00€

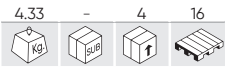

KIT PULIDORA



ACCESÓRIOS

REF.	DESCRIÇÃO				€
51388	LAMELA GROSSA ÂNGULO DE 23MM PARA REF. 51216	0.10	100	800	22,00€
51389	LAMELA GROSSA ÂNGULO 11MM PARA REF. 51216	0.05	1	800	22,00€
51390	LAMELA FINA LISA 23MM PARA REF. 51216	0.05	100	800	22,00€
51391	LAMELA FINA LISA 11MM PARA REF. 51216	0.04	1	800	22,00€
51392	LAMELA DE PINTURA PARA REF. 51216	0.20	100	800	34,00€
51393	LAMELA DE PINTURA COM AGUA PARA REF. 51216	0.10	50	800	34,00€
51439	SUPORTE PARA RODA 23MM	0.10	100	800	26,00€
51440	SUPORTE RODA 11MM	0.10	1	800	28,00€
51441	SUPORTE RODA PRETA DUPLO	0.10	1	800	26,00€
51442	SUPORTE RODA PRETA SIMPLE	0.10	50	800	28,00€

REF.	DESCRIÇÃO				€
14126	KIT DE REPARAÇÃO DE FERRAMENTAS PNEUMÁTICAS - 51216	0.01	-	10	54,00€

CONTÉM

Distintos Tipos de Rodas (Para a preparação de superfícies metálicas)
 11mm Escova de arame (Fino)
 23mm Escova de arame (Fino)
 11mm Escova de arame (grosso)
 23mm Escova de arame (grosso)
 Apagador de borracha
 Apagador de Pinturas com base de água
 Adaptador de 23mm para apagador de borracha e escova de arame
 Adaptador de 11mm da escova de arame
 Pulidor pedro de borracha dura (até 6 peças)
 Adaptor único do Pulidor de borracha dura
 Adaptador de dupla tira de borracha dura

53576

189,00€

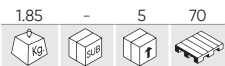

3" CONJUNTO PARA A MINIMÁQUINA DE POLIMENTO PNEUMÁTICA



REF.	DESCRIÇÃO				€
A	14162 ALMOFADA DE LÃ PARA REF. 53576	0.05	-	50	25,50€
B	14163 ALMOFADA ESPONJOSA MACIA PARA REF. 53576 - BRANCA	0.50	5	50	25,50€
C	14164 ALMOFADA ESPONJOSA DURA PARA REF. 53576 - AMARELA	0.50	5	50	25,50€
D	14330 DISCO VELCRO PARA 53576	0.01	5	50	3,50€
14154	KIT DE REPARAÇÃO DE FERRAMENTAS PNEUMÁTICAS - 53576	0.05	-	10	42,00€

53646

69,00€

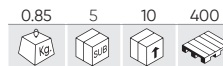

3" CONJUNTO PARA A MÁQUINA DE POLIMENTO PNEUMÁTICA



REF.	DESCRIÇÃO				€
A	14286 ALMOFADA ESPONJOSA MACIA PARA REF. 53646	0.01	10	200	2,99€
B	14287 ALMOFADA ESPONJOSA DURA PARA REF. 53646	0.00	10	200	2,99€
C	14288 ALMOFADA DE LÃ PARA REF. 53646	0.01	10	200	6,00€
D	14289 DISCO VELCRO PARA 53646	0.04	-	200	6,10€

53626

18,00€



KIT DE RESTAURAÇÃO DE FARÓIS

14 PCS



EM EXPOSITOR DE 12 UDS

CONTÉM

	x2	Ep800 discos de lixar		x1	85gm pasta de polimento
	x2	P1200 discos de lixar		x1	Fita adesiva
	x2	P2000 discos de lixar		x1	Disco de polimento de lã
	x2	3.0ml líquido protetor uv		x1	Disco de esponja branco
	x2	Adaptador (3/8" & 1/4")			



SERIE262

199,00€



KIT ESPECIAL POLIMENTO: MÁQUINA POLIMENTO NEUMÁTICA + 12 KIT RESTAURAÇÃO DE FARÓIS

53626

53646



52676

98,00€

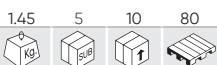

LIXADEIRA ORBITAL AUTO-ASPIRANTE



- Corpo de alumínio com punho gomado.
- Excelente desempenho de limpeza com bolsa e mangueira.



52675

84,00€



LIXADEIRA ORBITAL ADAPTÁVEL ASPIRADOR



52758

88,00€



LIXADEIRA ORBITAL ADAPTÁVEL ASPIRADOR



51226

233,00€

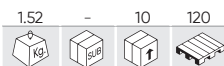

KIT MINI REBARBADORA

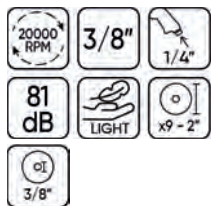

REF. DESCRIÇÃO

REF.	DESCRIÇÃO	kg	Box	Unit	€
14133	KIT DE REPARAÇÃO DE FERRAMENTAS PNEUMÁTICAS - 51226	0.01	-	10	16,50€

52157

48,00€

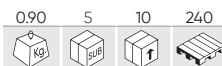

KIT DE 16 PEÇAS COM AMOLADORA PNEUMÁTICA



51245

99,00€



MINI AMOLADORA DE 3/8" 6MM



REF. DESCRIÇÃO

REF.	DESCRIÇÃO	kg	Box	Unit	€
14135	KIT DE REPARAÇÃO DE FERRAMENTAS PNEUMÁTICAS - 51245	0.01	-	10	12,50€

52171

39,00€



MINI AMOLADORA PNEUMÁTICA 1/4"



53141

68,00€

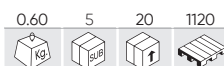

AMOLADORA PNEUMÁTICA



52528

49,00€



AMOLADORA ANGULAR PNEUMÁTICA



53137

38,00€

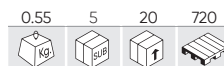

MINI AMOLADORA



51218

288,00€

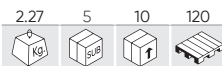

REBARBADORA ÂNGULAR COMPOSITE

COMPOSITE



REF. DESCRIÇÃO

REF.	DESCRIÇÃO	kg	Box	Unit	€
14127	KIT DE REPARAÇÃO DE FERRAMENTAS PNEUMÁTICAS - 51218	0.01	-	10	32,50€

FERRAMENTAS PNEUMÁTICAS

54255

68,00€

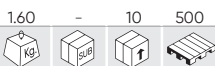

CONJUNTO COMPLETO DE ACESSÓRIOS
PISTOLA DE LUBRIFICAÇÃO

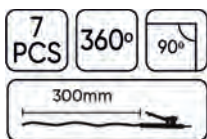

50751

43,00€

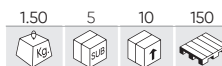

BOMBA DE MASSA PNEUMÁTICA

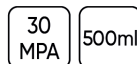

52490

6,65€

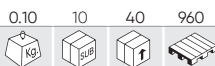

PISTOLA DE AR 100MM

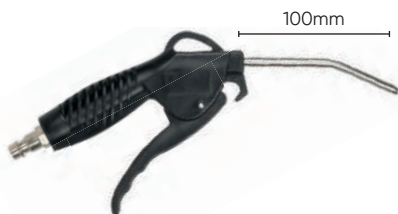

EM EXPOSITOR
DE 10 UDS



52491

10,50€



PISTOLA DE AR 300MM



EM EXPOSITOR
DE 10 UDS



53611

27,50€



PISTOLA DE AR EXTRA-LONGA



ALTO FLUXO

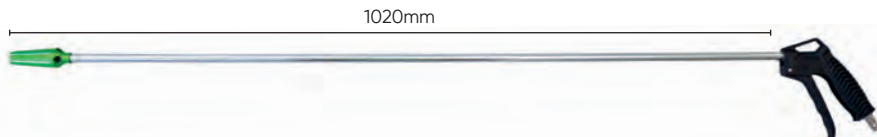

52798

18,00€

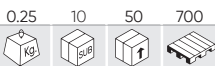

PISTOLA DE AR EXTENSÍVEL

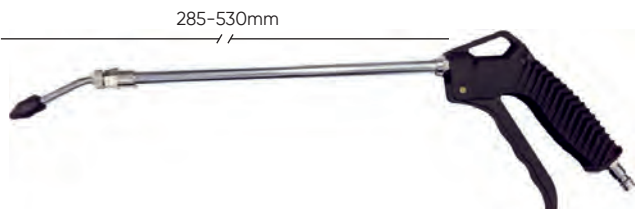

PUNTA EMBORRACHADO PARA EVITAR RISCOS

51980

15,00€

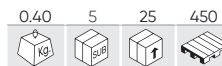

PISTOLA DE AR PARA PNEUMÁTICOS



51981 21,50€



PISTOLA DE AR+PISTOLA PARA PNEUMÁTICOS



51277 64,00€



KIT DE FERRAMENTAS PNEUMÁTICAS



52787 9,00€

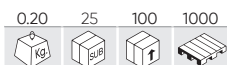

PISTOLA DE AR



51383 11,10€

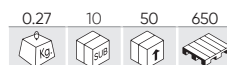

PISTOLA DE AR (EM BLISTER)

- Pistola de ar.
- Conexão rápida europeia.
- Conexão de mangueira.
- Tubo de 10cm.
- Tubo de 20cm.



EM EXPOSITOR DE 10 UDS



54251 43,00€



PISTOLA DE SOPRO E ASPIRAÇÃO



CONTÉM



53205 19,00€



PISTOLA DE AR GRAN CAUDAL



Alto fluxo

- Pistola de soprado de grande caudal.
- Material do corpo: Liga de alumínio.
- Superfície: Niquelado.

52381 20,50€



PISTOLA DE AR DE 3/8" COM MANGUEIRA DE 5M

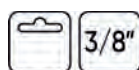

54248

58,00€

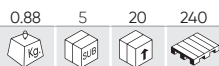

PISTOLA DE PINTURA

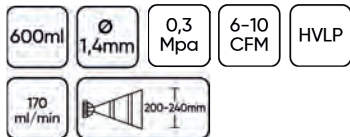

REPOSIÇÕES DISPONÍVEIS

54249

103,00€

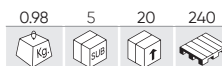

PISTOLA DE PINTURA PROFISSIONAL



REPOSIÇÕES DISPONÍVEIS

53606

55,00€

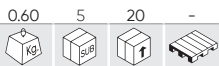

PISTOLA DE SECAGEM PNEUMÁTICA



VÁLVULA REGULADORA DE AR



53449

16,40€

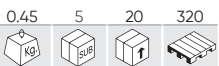

PISTOLA DE ENCHIMENTO ANALÓGICA

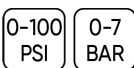

53450

28,30€

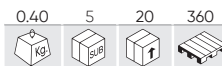

PISTOLA DE ENCHIMENTO DIGITAL

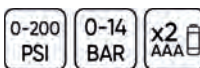

52648

9,00€



MEDIDOR DE PRESSÃO DOS PNEUS



4,3 BAR

53416

14,10€



MEDIDOR DE PRESSÃO DE PNEUMÁTICOS COM TUBO (0-10BAR)



0-10 BAR

53417

26,30€



MEDIDOR DE PRESSÃO DE PNEUMÁTICOS DIGITAL COM TUBO (0-15BAR)



0-200 PSI
0-15 BAR
0-1500 KPA

53418

16,90€



MEDIDOR DE PRESSÃO DE PNEUMÁTICOS DIGITAL (0-15BAR)



0-300 PSI
0-15 BAR
0-1500 KPA

51861

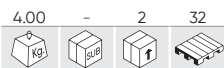

199,00€



MÁQUINA PNEUMÁTICA P/MONTAR FOLES DE TRANSMISSÕES

- Material: Alumínio.
- Abertura de 20 a 100mm.

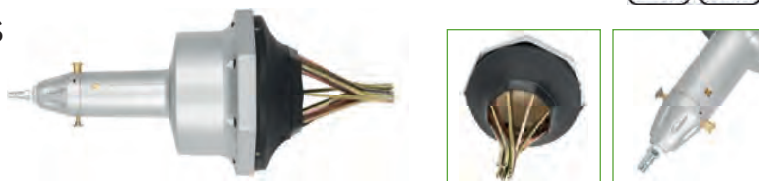

53542



980,00€

DESTANOLADOR PNEUMÁTICO DE PNEUS



REF. DESCRIÇÃO

14137 KIT DE REPARAÇÃO DE FERRAMENTAS PNEUMÁTICAS - 53542

0,65 5 5 131,00€

52540

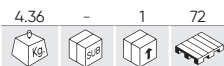

221,00€

VENTOSA PNEUMÁTICA COM MARTELO DESLIZANTE

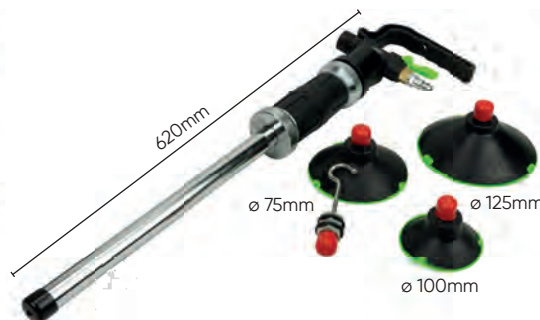
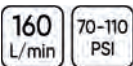

52331

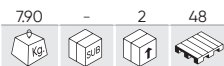

201,00€

KIT FERRAMENTAS PNEUMÁTICA

PISTOLA DE IMPACTO + MARTELO NEUMÁTICO + ROQUETE NEUMÁTICO + MINI POLIDORA NEUMÁTICA + PISTOLA DE BUFAR + PISTOLA DE BUFAR RETA



FERRAMENTAS PNEUMÁTICAS

52543

182,00€

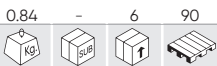

PISTOLA LIMPIADORA DE FILTROS DE PARTÍCULAS

- Universal.
- Base de alumínio
- Corpo inox de longa durada.
- Capacidade máxima: 650cc.
- Goma de nylon 4x6 x 2,7 m.
- Rango de pressão de trabalho: 3 bar - 7 bar (45 psi - 100PSI).



REF.	DESCRIÇÃO	Kg	L	Q	€
90003	LÍQUIDO DESCARBONIZANTE	1.08	-	12 400	35,20€
90004	LÍQUIDO NEUTRALIZANTE	0.50	-	12 320	25,80€

53625

68,00€

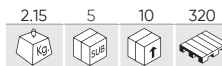

MARTELO DE AGULHAS PNEUMÁTICO



REF.	DESCRIÇÃO	Kg	L	Q	€
14188	AGULHA PARA REF. 53625	0.01	50	500	0,50€

53593

41,00€

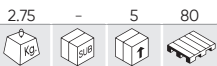

PISTOLA DE JACTO DE AREIA PNEUMÁTICA

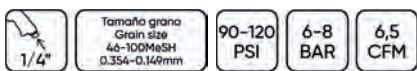

- CONTÉM**
- 1x pistola jateadora.
 - 1x Recolhedor de Areia.
 - 2x 850g recipientes de areia.

- Casquilhos 4x: para jateamento de superfície, para jateamento de canto exterior, para jateamento de canto interior.

REF.	DESCRIÇÃO	Kg	L	Q	€
14168	FRASCO DE AREIA (PARA REF.53593)	0.95	-	20	7,00€

53202

15,70€

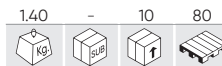

PISTOLA DE PETROLEADO



- Pistola de limpeza do motor.
- Material do pote: Aço.
- Material do corpo: liga de alumínio.
- Superfície: Pintura em pó.

53204

81,00€

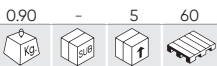

PISTOLA DE LIMPEZA TORNADO



- Pistola de limpeza de carros, tornado.
- Material a: PE.
- Material do corpo: Liga de alumínio.
- Superfície do corpo: Pulido.

52575

119,00€

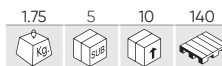

REBITADOR PNEUMÁTICO



53567

43,00€

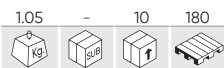

PISTOLA DE SILICONE PNEUMÁTICA



- Pressão de trabalho: 2,5-5 BAR.
- Entrada de ar: 1/4".
- Capacidade do cartucho: 310ml.

52533

10,00€

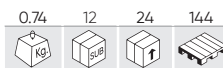

PISTOLA SILICONE 300ML

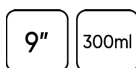

53572

348,00€



FERRAMENTA PNEUMÁTICA PARA POLIMENTO DE VÁLVULAS - PERCUSSÃO E ROTAÇÃO

CONTÉM

- 1 x máquina pneumática para válvulas.
- 5 x ventosa (16, 20, 30, 35 e 40 mm).
- 5 x adaptador de válvula.
- Chave Allen de 1 x 3 mm.



54033

49,00€



FERRAMENTA PARA BERBEQUIM - RODA VÁLVULAS

- Diâmetro ventosas: 16, 20, 30, 35, 40mm
- Conexão berbequim: 8mm
- Comprimento: 128mm
- Velocidade máxima de trabalho: 1250rpm



REF.	mm				€
14157	16	0.01	-	50	8,30€
14158	20	0.01	-	50	9,95€
14159	30	0.01	-	50	12,60€
14160	35	0.01	-	50	12,80€
14161	40	0.10	-	50	13,70€



REF.	mm				€
14157	16	0.01	-	50	8,30€
14158	20	0.01	-	50	9,95€
14159	30	0.01	-	50	12,60€
14160	35	0.01	-	50	12,80€
14161	40	0.10	-	50	13,70€



14534

16,50€



ÓLEO PARA FERRAMENTA PNEUMÁTICA - 600ML

- Densidade relativa a 15 °C: 0,845.
- Viscosidade: 12,1 cSt a 40 °C.
- Cor: Incolor.



14560

8,80€



ÓLEO PARA FERRAMENTA PNEUMÁTICA - 100ML

- Densidade relativa a 15 °C: 0,845.
- Viscosidade: 12,1 cSt a 40 °C.
- Cor: Incolor.



FERRAMENTAS PNEUMÁTICAS



DISCOS DE CORTE

REF.	DESCRIÇÃO					€
51385	DISCO CORTE DE 4"X1/32" PARA 51219	0.01	10	300	800	4,55€
51387	DISCO DE CORTE DE 3"	0.03	10	300	800	3,25€



DISCOS LIXA

REF.	DESCRIÇÃO					€
51386	DISCO LIXA DE 5" PARA 51218	0.10	-	25	800	5,95€
51443	DISCO DE LIXA #60 PARA REF. 51226	0.50	25	150	800	5,50€
51444	DISCO DE LIXA #80 PARA REF. 51226	0.02	-	25	800	5,05€
51445	DISCO DE LIXA #120 PARA REF. 51226	0.02	-	25	800	5,05€



DISCO PARA LIXADEIRAS

REF.	DESCRIÇÃO					€
13499	DISCO DE 15 BURACOS PARA LIXADEIRAS	0.10	-	50	1500	12,50€
13500	DISCO DE 66 BURACOS PARA LIXADORAS	0.65	5	50	-	12,90€
12009	DISCO DE 6 BURACOS PARA LIXADEIRAS	0.14	-	50	-	11,00€



FILTRO E REGULADOR DE AR

REF.	"					€
53063	1/4"	0.60	5	50	300	36,70€
53064	3/8"	0.63	5	50	300	37,40€
53065	1/2"	0.60	5	50	300	36,90€



FILTRO, REGULADOR DE AR E LUBRIFICADOR

REF.	"					€
53066	1/4"	1.08	5	25	250	61,00€
53067	3/8"	0.50	5	25	250	61,00€
53068	1/2"	1.00	5	25	250	63,00€



53492

380,00€

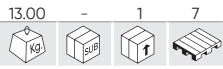

EXPOSITOR DE FERRAMENTA PNEUMÁTICA

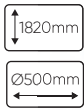

EXPOSITOR SEM FERRAMENTAS



52378

10,00€

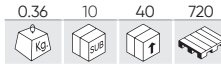

GANCHO MAGNÉTICO

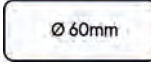
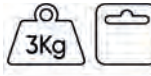

51341

35,00€

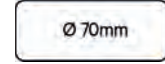
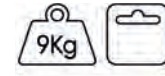

53147

41,00€

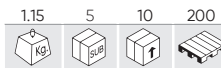

EXPOSITOR DE FERRAMENTA PNEUMÁTICA



EXPOSITOR SEM FERRAMENTAS

53594

54,00€



MANGUEIRA DE AR 8MM - 25M



HYBRID POLYMER
POLÍMERO HÍBRIDO

- Pressão de trabalho: 300PSI / 20bar.
- Pressão de ruptura: 950PSI / 65bar.
- Temperatura de trabalho: -40°C / 65°C

- Grande flexibilidade.
- Retorna à sua forma original.
- Superfície lisa, não danifica a pintura.
- Muito resistente.

Diâmetro interior: 8mm
Diâmetro exterior: 13mm

Para usar com:
REF. 52736 (M8)



53595

61,00€



MANGUEIRA DE AR 10MM - 25M



HYBRID POLYMER
POLÍMERO HÍBRIDO

- Pressão de trabalho: 300PSI / 20bar.
- Pressão de ruptura: 950PSI / 65bar.
- Temperatura de trabalho: -40°C / 65°C

- Grande flexibilidade.
- Retorna à sua forma original.
- Superfície lisa, não danifica a pintura.
- Muito resistente.

Diâmetro interior: 10mm
Diâmetro exterior: 15mm

Para usar com:
REF. 52737 (M10)



REF. DESCRIÇÃO

14169 JOGO DE 10 BRAÇADEIRAS 8-16 MM

0.10 - 125 - 3,00€

FERRAMENTAS PNEUMÁTICAS

MANGUEIRA ESPIRAL PNEUMÁTICA

REF.	m			"					€
53629	10m	8mm	5mm	1/4"	0.55	-	6	360	14,30€
53630	15m	8mm	5mm	1/4"	0.65	-	6	240	18,80€
53631	15m	12mm	8mm	1/4"	1.25	-	6	120	33,50€
53632	15m	15mm	10mm	1/4"	2.20	-	6	78	46,00€
53633	15m	15mm	10mm	3/8"	2.10	-	6	78	46,00€
53634	15m	18mm	13mm	1/2"	2.60	-	6	66	63,00€



COM EXTREMIDADES GIRATÓRIAS DE 360 GRAUS PARA FACILITAR O MOVIMENTO E A FACILIDADE DE USO

- MATERIAL DA MANGUEIRA: PU.
- SUPERFÍCIE ROSCADA: LATÃO.

CARRETEL DE MANGUEIRA DE AR BOCA



COM REPARTIDOR



SUPORTE DE PAREDE INCLuíDO

14772 8,50€



REF. 53582 / REF. 53583



SUPORTE DE PAREDE INCLuíDO

14771 10,50€



REF. 53532 / REF. 53581

20+2m

REF.	m	"					€
53582	22m	3/8"	10.85	-	1	14	174,00€
53583	22m	3/8"	10.75	-	1	14	174,00€



12+1m

REF.	m	"					€
53532	13m	3/8"	6.60	-	2	30	119,00€
53581	13m	3/8"	6.70	-	2	30	119,00€



10+1,5m

REF.	m	"					€
53881	11,5m	1/4"	4.50	-	4	48	79,00€
53882	11,5m	1/4"	4.50	-	4	48	79,00€



CONECTOR DE MANGUEIRA

REF.	DESCRIÇÃO					€
14204	EUR - M6 M 1/4"	0.06	50	200	-	1,50€
14205	EUR - M8 M 3/8"	0.06	50	200	-	1,50€
14206	EUR - M10 M 1/2"	0.05	50	200	-	1,50€
14207	US - M6 M 1/4"	0.05	50	200	-	1,50€
14208	US - M8 M 3/8"	0.06	50	200	-	1,50€
14209	US - M10 M 1/2"	0.05	50	200	-	1,50€



CONECTOR UNIVERSAL DE SEGURANÇA PARA MANGUEIRA

REF.	DESCRIÇÃO					€
14201	M6	0.10	25	100	-	4,00€
14202	M8	0.10	25	100	-	4,00€
14203	M10	0.10	25	100	-	4,50€



CONECTOR / ROSCA

REF.	DESCRIÇÃO				€
13930	CONECTOR MACHO US - ROSCA MACHO DE 1/4"	0.01	50	100	1,50€
13932	CONECTOR MACHO US - ROSCA MACHO 3/8"	0.10	50	100	2,50€
14076	CONECTOR MACHO US - ROSCA FÊMEA DE 3/8"	0.10	50	100	1,50€
13933	CONECTOR MACHO US - ROSCA MACHO DE 1/2"	0.10	50	100	2,00€
13935	CONECTOR MACHO US - ROSCA FÊMEA DE 1/4" (2 PEÇAS)	0.05	50	100	2,50€
13936	CONECTOR FÊMEA US - ROSCA FÊMEA DE 1/4"	0.05	50	100	3,50€
13937	CONECTOR FÊMEA US - ROSCA MACHO DE 1/4"	0.05	50	100	4,00€
14078	CONECTOR FÊMEA US - ROSCA FÊMEA DE 3/8"	0.10	50	100	4,00€
14191	CONECTOR MACHO US - ROSCA FÊMEA DE 1/2"	0.05	50	100	2,00€
14193	CONECTOR FÊMEA US - ROSCA FÊMEA DE 1/2"	0.10	50	100	4,00€

EUR

REF.	DESCRIÇÃO				€
13931	CONECTOR MACHO EUR - ROSCA MACHO DE 1/4" (2 PEÇAS)	0.05	50	100	2,50€
14075	CONECTOR MACHO EUR - ROSCA FÊMEA DE 3/8"	0.10	50	100	2,00€
13934	CONECTOR MACHO EUR - ROSCA FÊMEA DE 1/4" (2 PEÇAS)	0.05	50	100	2,50€
13938	CONECTOR FÊMEA EUR - ROSCA FÊMEA DE 1/4"	0.10	50	200	3,50€
13939	CONECTOR FÊMEA EUR - ROSCA MACHO DE 1/4"	0.10	50	100	4,00€
14077	CONECTOR FÊMEA EUR - ROSCA FÊMEA DE 3/8"	0.10	50	100	4,50€
14190	CONECTOR MACHO EUR - ROSCA FÊMEA DE 1/2"	0.05	50	100	2,00€
14192	CONECTOR FÊMEA EUR - ROSCA FÊMEA DE 1/2"	0.10	50	100	4,00€



CONECTOR DE SEGURANÇA UNIVERSAL

REF.	DESCRIÇÃO						€
14195	ROSCA INTERNA - ROSCA EXTERNA 1/4"	0.50	25	100	-	-	4,00€
14196	ROSCA INTERNA - ROSCA EXTERNA 3/8"	0.10	25	100	-	-	4,00€
14197	ROSCA INTERNA - ROSCA EXTERNA 1/2"	0.10	25	100	-	-	4,50€
14198	ROSCA INTERNA - ROSCA INTERNA 1/4"	0.10	25	100	-	-	4,00€
14199	ROSCA INTERNA - ROSCA INTERNA 3/8"	0.10	25	100	-	-	4,00€
14200	ROSCA INTERNA - ROSCA INTERNA 1/2"	0.10	25	100	-	-	4,50€



CONECTOR ARTICULADO MACHO PARA AR COMPRIMIDO EURO

REF.	DESCRIÇÃO						€
14314	EUR 1/4"	0.06	25	100	-	-	5,00€
14315	US 1/4"	0.06	25	100	-	-	4,50€



14561

0.05	25	50	-

CONECTOR LUBRIFICANTE 1/4"



8,80€



ENGATE RÁPIDO PNEUMÁTICO

REF.	DESCRIÇÃO						€
52735	ENGATE RÁPIDO PNEUMÁTICO M6	0.05	25	200	4000	-	4,85€
52736	ENGATE RÁPIDO PNEUMÁTICO M8	0.10	25	200	4000	-	5,35€
52737	ENGATE RÁPIDO PNEUMÁTICO M10	0.10	25	200	4000	-	5,50€



ADAPTADOR ARTICULADO

REF.	DESCRIÇÃO						€
12988	ADAPTADOR ARTICULADO PNEUMÁTICO DE 1/2"	0.15	62	125	-	-	12,00€
13809	ADAPTADOR ARTICULADO 1/4"	0.10	62	250	-	-	18,50€
13810	ADAPTADOR ARTICULADO 3/8"	0.10	62	250	-	-	20,50€



FERRAMENTAS DE IMPACTO

- 168 CHAVES DE CAIXA DE IMPACTO
- 173 ESPECIAL PNEUS
- 174 ADAPTADORES
- 176 PEÇAS SOBRESSALENTES DE CHAVES DE IMPACTO
- 177 ESPECIAL CAMINHÕES



52694

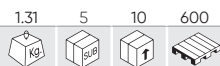

KIT DE 3 CHAVES XZN DE 1/2" DE IMPACTO

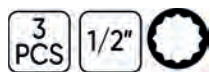

CONTÉM



x3 30, 32, 36mm



49,00€

52337



KIT DE 6 CHAVES DE IMPACTO DE 1/2"



CONTÉM



x3 30, 32, 36mm



x3 14, 17, 19mm

52547



KIT DE 8 CHAVES E PUNTAS XZN DE IMPACTO DE 1/2"

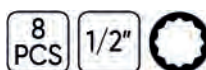

CONTÉM

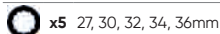

x5 27, 30, 32, 34, 36mm

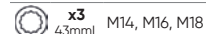

x3 M14, M16, M18

96,00€

52345



KIT DE 19 CHAVES DE IMPACTO DE 1/2" HEX + ADAPTADOR



10, 11, 12, 13, 14, 15, 16, 17, 18, 19, 21, 22, 24, 27mm



REPOSIÇÕES DISPONÍVEI

REF.	mm				€
14728	10	0.10	5	20	3,80€
14729	11	0.05	10	100	3,80€
14730	12	0.05	10	100	3,80€
14731	13	0.10	5	20	3,80€
14732	14	0.10	5	20	3,80€
14970	15	0.08	5	20	2,50€
14971	16	0.07	5	20	2,50€

REF.	mm				€
11195	17	0.10	10	100	3,70€
14972	18	0.12	5	20	3,50€
11121	19	0.10	10	60	4,10€
14733	21	0.10	5	20	4,30€
14734	22	0.15	5	20	5,40€
11122	24	0.14	10	20	5,45€
11123	27	0.20	10	50	6,50€

REF.	DESCRIÇÃO				€
12937	EXTENSORES DE IMPACTO DE 50MM 1/2"	0.11	10	100	9,50€
14973	AUMENTO DE IMPACTO DE 150MM 1/2"	0.27	5	20	11,50€
12075	AUMENTO DE IMPACTO DE 250MM 1/2"	0.45	10	50	15,50€
11962	ADAPTADOR DE IMPACTO 1/2" F 3/4" M	0.17	10	100	7,50€
11990	ARTICULAÇÃO UNIVERSAL DE IMPACTO DE 1/2"	0.15	10	100	15,30€

109,00€

53531

109,00€



KIT DE 19 CHAVES DE IMPACTO DE 1/2" DE 12 FACES + ADAPTADOR

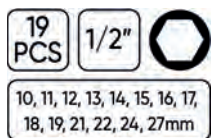

10, 11, 12, 13, 14, 15, 16, 17,
18, 19, 21, 22, 24, 27mm



REPOSIÇÕES DISPONÍVEL

REF.	DESCRIÇÃO	kg	box	box	€
12937	EXTENSORES DE IMPACTO DE 50MM 1/2"	0.11	10	100	9,50€
14973	AUMENTO DE IMPACTO DE 150MM 1/2"	0.27	5	20	11,50€
12075	AUMENTO DE IMPACTO DE 250MM 1/2"	0.45	10	50	15,50€

REF.	DESCRIÇÃO	kg	box	box	€
11962	ADAPTADOR DE IMPACTO 1/2" F 3/4" M	0.17	10	100	7,50€
11990	ARTICULAÇÃO UNIVERSAL DE IMPACTO DE 1/2"	0.15	10	100	15,30€

52341

58,00€

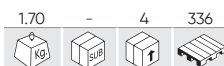

KIT DE 13 CHAVES DE IMPACTO DE 1/2" HEX. + ADAPTADOR



10, 11, 12, 13, 14, 17,
19, 21, 22, 24mm



REPOSIÇÕES DISPONÍVEL

REF.	mm	kg	box	box	€
14728	10	0.10	5	20	3,80€
14729	11	0.05	10	100	3,80€
14730	12	0.05	10	100	3,80€
14731	13	0.10	5	20	3,80€
14732	14	0.10	5	20	3,80€

REF.	mm	kg	box	box	€
11195	17	0.10	10	100	3,70€
11121	19	0.10	10	60	4,10€
14733	21	0.10	5	20	4,30€
14734	22	0.15	5	20	5,40€
11122	24	0.14	10	20	5,45€

REF.	DESCRIÇÃO	kg	box	box	€
14735	SUPOORTE DE JUNTAS DE IMPACTO DE 1/2"	0.05	5	20	6,50€
12074	AUMENTO DE IMPACTO DE 125MM 1/2"	0.23	10	60	11,50€
11990	ARTICULAÇÃO UNIVERSAL DE IMPACTO DE 1/2"	0.15	10	100	15,30€

52346

103,00€



KIT DE 12 CHAVES DE IMPACTO COMPRIDOS DE 1/2"



REPOSIÇÕES DISPONÍVEL

REF.	mm	kg	box	box	€
12061	10	0.14	10	100	9,50€
12062	12	0.15	10	100	9,50€
12063	13	0.15	10	50	9,50€
12064	15	0.17	10	100	9,00€
12065	16	0.30	10	20	9,00€
12066	17	0.20	10	100	9,00€

REF.	mm	kg	box	box	€
12067	18	0.22	10	20	9,50€
12068	19	0.21	10	50	9,50€
12069	21	0.25	10	50	9,50€
12070	22	0.27	10	100	10,50€
12071	24	0.30	10	50	11,00€
12072	27	0.36	10	20	12,00€

REF.	DESCRIÇÃO	kg	box	box	€
12074	AUMENTO DE IMPACTO DE 125MM 1/2"	0.23	10	60	11,50€
12075	AUMENTO DE IMPACTO DE 250MM 1/2"	0.45	10	50	15,50€
11990	ARTICULAÇÃO UNIVERSAL DE IMPACTO DE 1/2"	0.15	10	100	15,30€

53060

34,90€

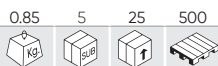

JOGO DE 12 CHAVES DE IMPACTO 1/2" HEX. PERFIL BAIXO

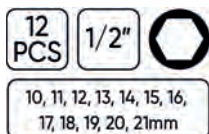

52342

63,00€

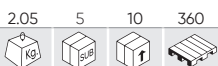

KIT DE 11 CHAVES DE IMPACTO HEX. DE 1/2"

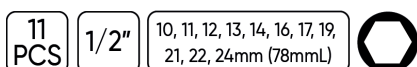

REPOSIÇÕES DISPONÍVEI

REF.	mm				€
12061	10	0.14	10	100	9,50€
14736	11	0.15	5	20	5,00€
12062	12	0.15	10	100	9,50€
12063	13	0.15	10	50	9,50€
14737	14	0.15	5	20	5,00€
12065	16	0.30	10	20	9,00€

REF.	mm				€
12066	17	0.20	10	100	9,00€
12068	19	0.21	10	50	9,50€
12069	21	0.25	10	50	9,50€
12070	22	0.27	10	100	10,50€
12071	24	0.30	10	50	11,00€

53744

63,00€

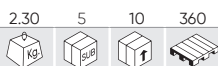

KIT DE 11 PCS. CABEÇA ALTA DE CHOQUE DE 12 LADOS 1/2"

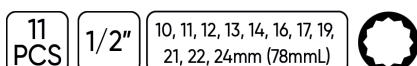

REPOSIÇÕES DISPONÍVEI

REF.	mm				€
14738	10	0.15	10	100	5,50€
14739	11	0.15	10	100	5,50€
14740	12	0.16	10	100	5,55€
14741	13	0.15	10	100	5,55€
14742	14	0.15	10	100	5,55€
14743	16	0.14	10	100	5,15€

REF.	mm				€
14744	17	0.18	10	50	5,35€
14745	19	0.22	10	50	6,25€
14746	21	0.24	10	50	6,40€
14747	22	0.27	10	50	7,10€
14748	24	0.30	10	50	8,30€

52810

9,00€

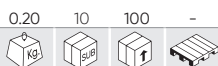

CHAVE DE IMPACTO XZN INVIOVÁVEL M16

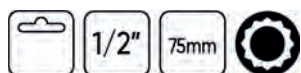

- Soquetes de impacto de 75mm de comprimento quadrados de 1/2" para extrair o parafuso de drenagem com chave de impacto em transmissões de VAG, Porsche, Ford, etc.

52811

9,90€

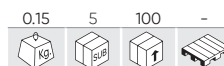

CHAVE DE IMPACTO XZN INVIOVÁVEL M18

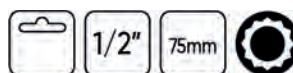

- Para extrair o braço de direção do veículos do grupo VAG.

52546

39,60€

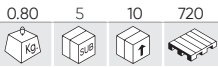

KIT DE 6 CHAVES E PUNTAS XZN DE IMPACTO DE 1/2"



REPOSIÇÕES DISPONÍVEI

REF.	43mmL	kg	SUB	Q	€	REF.	78mmL	kg	SUB	Q	€
12931	M14	0.08	10	200	7,50€	12934	M14	0.13	10	200	7,50€
12932	M16	0.08	10	200	7,50€	12935	M16	0.14	10	200	8,00€
12933	M18	0.09	10	200	8,00€	12936	M18	0.16	10	200	8,50€

52344

197,00€

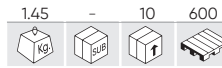

KIT DE 13 CHAVES DE IMPACTO DE 1/2" HEX E TORX



CONTÉM

- x5 45mmL 5, 6, 8, 10, 12mm
- x8 45mmL T30, T40, T45, T50, T55, T60, T70, T80

52339

61,00€

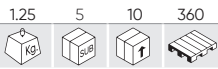

KIT DE 8 CHAVES DE IMPACTO HEX. DE 1/2"



REPOSIÇÕES DISPONÍVEI

REF.	mm	kg	SUB	Q	€	REF.	mm	kg	SUB	Q	€
14004	5	0.30	10	240	9,50€	14008	10	0.11	10	240	9,50€
14005	6	0.09	10	120	10,50€	14009	12	0.12	10	240	9,50€
14006	7	0.09	10	240	9,50€	14010	14	0.14	10	120	11,00€
14007	8	0.10	10	240	9,50€	14011	17	0.18	10	60	11,00€

52340

58,00€

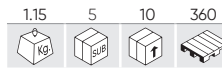

KIT DE 8 CHAVES DE IMPACTO TORX DE 1/2"



REPOSIÇÕES DISPONÍVEI

REF.	mm	kg	SUB	Q	€	REF.	mm	kg	SUB	Q	€
12938	T25	0.08	10	50	10,00€	12942	T50	0.10	10	60	10,00€
12939	T30	0.10	10	50	10,00€	12943	T55	0.10	10	50	10,00€
12940	T40	0.10	10	50	10,00€	12944	T60	0.12	10	50	10,00€
12941	T45	0.09	10	50	10,00€	12945	T70	0.15	10	50	10,50€

53470

176,00€

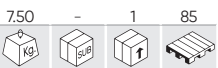

KIT DE 8 CHAVES DE IMPACTO LARGAS HEX. DE 3/4"

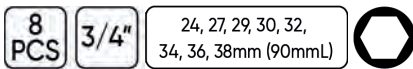

52347

158,00€

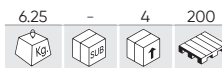

KIT DE 8 CHAVES DE IMPACTO HEX. 3/4"

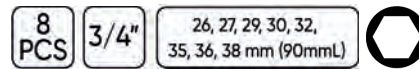

51028

163,00€

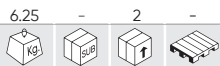

KIT DE 16 CHAVES DE IMPACTO

16 PCS 3/4"

REPOSIÇÕES DISPONÍVEI

REF.	mm	kg	box	unit	€
14723	H17	0.35	-	10	18,00€
14724	T60	0.30	-	10	18,50€
14725	T70	0.30	-	10	18,50€
14726	T80	10.80	-	10	17,50€

	3/4"	x4	E18, E20, E22, E24
	3/4"	x5	T60, T70, T80, T90, T100
	3/4"	x4	H17, H19, H22, H24
		x2	1 - 3/4"
		x1	4mm



54316

182,00€



CONJUNTO DE 8 CHAVES DE IMPACTO LONGAS 1"

8 PCS 1"



x6	90mmL	24, 27, 30, 32, 33, 36mm
x2	95mmL	38, 41mm



REPOSIÇÕES DISPONÍVEI

REF.	mm	kg	box	unit	€
16304	24	0.60	6	24	31,00€
16305	27	0.70	6	24	31,00€
16571	30	0.77	6	24	32,00€
16572	32	0.95	6	24	33,50€
16574	33	0.94	-	-	34,00€
16575	36	1.00	6	24	34,50€
16576	38	1.25	6	24	35,50€
16577	41	1.32	6	24	36,00€

52348

179,00€

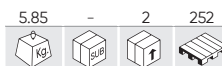

KIT DE 8 CHAVES DE IMPACTO DE 1"

8 PCS 1"



x2	58mmL	24, 27mm
x3	62mmL	30, 32, 33mm
x2	65mmL	36, 38mm
x1	68mmL	41mm



REPOSIÇÕES DISPONÍVEI

REF.	mm	kg	box	unit	€
13859	24	0.50	6	24	16,00€
13874	27	0.60	6	72	17,50€
13875	30	0.50	6	18	18,50€
13876	32	0.60	6	24	18,50€
13877	33	0.60	6	96	18,50€
11153	36	0.70	6	18	23,40€
11155	38	0.90	6	12	24,40€
11158	41	0.95	6	18	28,50€

52969

20,70€



KIT DE 3 CHAVES DE IMPACTO HEX. LONGO

3 PCS 1/2"



17, 19, 21mm (78mmL)

REPOSIÇÕES DISPONÍVEI

REF.	mm	kg	box	unit	€
12066	17	0.20	10	100	9,00€
12068	19	0.21	10	50	9,50€
12069	21	0.25	10	50	9,50€



53587

44,00€



CONJUNTO DE 4 CHAVES DE CAIXA DE IMPACTO PARA RODAS DE LIGA LEVE - 1/2"



REPOSIÇÕES DISPONÍVEI

REF.	mm	mmL		kg	pcs	pcs	€
14172	15mm	85mmL	SMART	0.20	10	50	8,50€
14173	17mm	85mmL	MERCEDES-BENZ	0.20	10	50	9,50€
14177	22mm	85mmL	OPEL	0.25	10	50	9,50€
14178	21mm	85mmL	HYUNDAI / KIA	0.25	10	50	9,50€

52338

41,00€



KIT DE 4 CHAVES IMPACTO DE 1/2" PARA RODAS



REPOSIÇÕES DISPONÍVEI

REF.	mm	kg	pcs	pcs	€
11314	17	0.22	10	100	8,50€
11315	19	0.25	10	100	8,50€
11316	21	0.26	10	100	8,50€
11628	22	0.27	10	50	9,50€



51336

29,30€



KIT DE 3 CHAVES DE IMPACTO DE 1/2"



REPOSIÇÕES DISPONÍVEI

REF.	mm	kg	pcs	pcs	€
11314	17	0.22	10	100	8,50€
11315	19	0.25	10	100	8,50€
11316	21	0.26	10	100	8,50€

52343

52,00€



KIT DE 12 CHAVES DE IMPACTO DE 1/2" HEX. - ESPECIAL EXTRAÇÃO RODAS

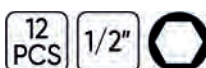

CONTÉM

Hexagonal Socket	x3	17, 19, 21mm
	85mmL	
Hexagonal Socket	x1	27mm
	42mmL	
Hexagonal Socket	x8	10, 11, 13, 14, 17, 19, 22, 24mm
	38mmL	

53988

101,00€



KIT DE 10 CHAVES DE IMPACTO DE 1/2"



CONTÉM

A	Hexagonal Socket	1/2"	15mm	F	Hexagonal Socket	1/2"	23mm
B	Hexagonal Socket	1/2"	17mm	G	Hexagonal Socket	1/2"	24mm
C	Hexagonal Socket	1/2"	19mm	H	Hexagonal Socket	7/8"	TESLA
D	Hexagonal Socket	1/2"	21mm	I	Hexagonal Socket	17mm	MERCEDES
E	Hexagonal Socket	1/2"	22mm	J	Hexagonal Socket	21mm	HYUNDAI / KIA



53197

46,00€

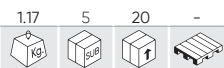

KIT DE 4 CHAVES DE IMPACTO PARA PARAFUSOS DE SEGURIDADE



17, 19, 21, 22mm
(82mmL)



CONTÉM

x4 82mmL 17, 19, 21, 22mm

53077

62,00€



KIT DE BARRAS DE EXTENSÃO DE IMPACTO



REPOSIÇÕES DISPONÍVEIS

	REF.	Nm					€
A	13688	100	0.22	-	-	1500	15,50€
B	13687	110	0.22	5	50	-	15,50€
C	13686	120	0.23	5	50	1000	15,50€
D	13685	135	0.25	5	50	1500	15,50€
E	13684	150	0.28	-	50	-	15,50€



VOCÊ PODE GOSTAR...

	REF.	Nm					€
F	13680	200	0.36	50	50	-	15,50€
G	13681	190	0.35	-	50	-	15,50€
H	13682	175	0.32	-	50	-	15,50€
I	13683	160	0.30	-	50	-	15,50€
J	13689	90	0.20	5	50	1500	15,50€



AUMENTO DE IMPACTO

REF.	mm	"					€
12937	50	1/2"	0.11	10	100	1500	9,50€
12074	125	1/2"	0.23	10	60	-	11,50€
12075	250	1/2"	0.45	10	50	-	15,50€

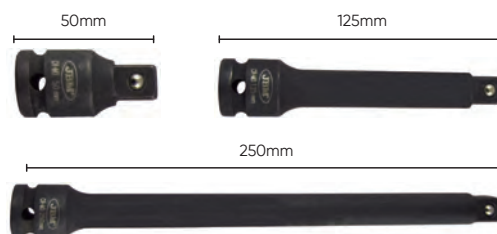

ARTICULAÇÃO UNIVERSAL DE IMPACT

REF.	"					€
11938	3/4"	0.62	10	50	-	47,00€
11990	1/2"	0.15	10	100	-	15,30€



53043

53,00€

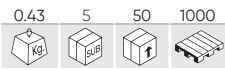

KIT DE 3 ARTICULAÇÕES DE IMPACTO COM DUPLA POSIÇÃO (FIXO / ARTICULADO)



53044

121,00€

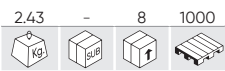

KIT DE 8 CHAVES DE IMPACTO HEX. COM DUPLA POSIÇÃO (FIXO / ARTICULADO)

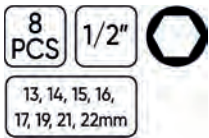

13, 14, 15, 16,
17, 19, 21, 22mm



52545

177,00€

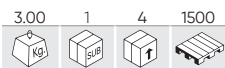

JOGO DE 2 ADAPTADORES DE IMPACTO

1" 1/2" F - 1" M
1" F - 1" 1/2" M



53743

39,70€



KIT DE 6 ADAPTADORES DE IMPACTO



REPOSIÇÕES DISPONÍVEI

REF.	mm				€
14749	1/4"H - 3/8"M	0.03	20	200	2,00€
14750	3/8"H - 1/4"M	0.05	20	100	2,00€
14751	3/8"H - 1/2"M	0.15	20	100	4,00€
14752	1/2"H - 3/8"M	0.16	10	100	4,00€
11962	1/2"H - 3/4"M	0.17	10	100	7,50€
11964	3/4"H - 1/2"M	0.35	10	100	12,50€

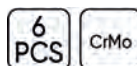

52544

93,00€



KIT DE 6 ADAPTADORES DE IMPACTO



REPOSIÇÕES DISPONÍVEI

REF.	mm				€
11962	1/2"H - 3/4"M	0.17	10	100	7,50€
11963	1/2"H - 1"M	0.25	6	54	9,00€
11964	3/4"H - 1/2"M	0.35	10	100	12,50€
11965	3/4"H - 1"M	0.45	6	48	16,00€
11966	1"H - 1/2"M	0.54	6	36	18,00€
11967	1"H - 3/4"M	0.56	4	36	18,00€

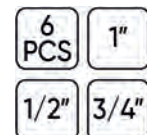

CHAVES DE CAIXA DE IMPACTO



1"

REF.	mm				€
11153	36	0.70	6	18	23,40€
11154	37	0.73	6	24	21,70€
11155	38	0.90	6	12	24,40€
11156	39	0.74	6	24	28,90€
11157	40	0.78	6	12	26,60€
11158	41	0.95	6	18	28,50€
11159	42	1.00	6	18	30,30€
11160	43	0.95	6	12	27,00€
11161	44	0.90	6	18	32,30€
11162	45	1.10	4	8	29,10€
11163	46	1.00	4	12	32,70€
11164	47	1.05	4	8	30,70€
11165	48	1.00	4	8	34,60€
11166	50	1.21	4	12	30,90€
11167	51	1.18	4	8	38,00€
11168	52	1.18	1	10	41,00€
11169	53	1.27	4	12	39,20€
11170	54	1.33	4	12	40,00€
11171	55	1.44	2	8	51,00€
11172	56	1.47	4	8	48,00€
11173	57	1.44	4	8	47,00€
11174	58	1.58	4	8	47,00€
11175	59	1.58	4	120	49,00€
11176	60	1.75	2	4	56,00€
11177	62	1.63	2	4	55,00€
11178	63	1.75	-	8	53,00€
11179	65	1.87	2	8	65,00€
11180	67	1.93	2	8	59,00€
11181	68	1.93	2	8	65,00€
11182	70	2.05	2	4	73,00€
11183	71	3.10	-	6	70,00€
11184	73	3.27	-	4	87,00€
11185	75	3.34	-	6	97,00€
11186	76	3.35	-	5	91,00€
11187	78	3.47	-	5	98,00€
11188	80	3.60	-	4	103,00€
11189	85	3.80	-	4	121,00€
11190	89	3.80	-	2	138,00€
11191	90	3.90	1	4	149,00€
11192	92	4.85	-	2	152,00€
11193	95	4.90	-	2	183,00€
11194	100	4.43	1	4	176,00€
11621	105	8.50	-	2	290,00€
11622	110	8.13	1	2	399,00€
11623	115	8.62	-	2	489,00€

1" (90mmL)

EXTRA LONGO

REF.	mm				€
13745	28	0.77	6	24	25,20€
13746	30	0.95	6	12	25,40€
13747	32	0.92	6	12	25,40€
13748	33	0.88	6	12	24,90€

1/2"

REF.	mm				€
14728	10	0.10	5	20	3,80€
14729	11	0.05	10	100	3,80€
14730	12	0.05	10	100	3,80€
14731	13	0.10	5	20	3,80€
14732	14	0.10	5	20	3,80€
11195	17	0.10	10	100	3,70€
11121	19	0.10	10	60	4,10€
14733	21	0.10	5	20	4,30€
14734	22	0.15	5	20	5,40€
11122	24	0.14	10	20	5,45€
11123	27	0.20	10	50	6,50€
11124	30	0.20	10	50	7,65€
11125	32	0.23	10	50	8,50€

1/2" (78mmL)

LONGO

REF.	mm				€
12061	10	0.14	10	100	9,50€
14736	11	0.15	5	20	5,00€
12062	12	0.15	10	100	9,50€
12063	13	0.15	10	50	9,50€
14737	14	0.15	5	20	5,00€
12064	15	0.17	10	100	9,00€
12065	16	0.30	10	20	9,00€
12066	17	0.20	10	100	9,00€
12067	18	0.22	10	20	9,50€
12068	19	0.21	10	50	9,50€
12069	21	0.25	10	50	9,50€
12070	22	0.27	10	100	10,50€
12071	24	0.30	10	50	11,00€
12072	27	0.36	10	20	12,00€

3/4"

REF.	mm				€
11126	19	0.25	-	10	11,20€
11127	21	0.30	6	24	13,80€
11128	22	0.35	6	24	14,10€
11129	24	0.32	6	54	14,10€
11130	25	0.45	6	24	13,10€
11131	26	0.32	6	36	14,10€
11132	27	0.30	6	54	13,70€
11133	28	0.40	6	12	12,00€
11134	30	0.41	6	24	15,00€
11135	32	0.45	6	48	17,20€
11136	33	0.50	6	12	15,30€
11137	34	0.50	6	24	18,20€
11138	35	0.50	6	12	18,00€
11139	36	0.50	6	24	18,80€
11140	38	0.55	6	24	20,40€
11141	40	0.55	6	12	18,60€
11142	41	0.60	6	12	21,30€
11143	46	0.75	6	18	26,40€
11144	50	1.00	6	24	33,30€
11145	51	1.10	4	12	35,30€
11146	55	1.23	4	12	37,30€
11147	57	1.25	4	12	41,00€
11148	60	1.40	4	12	47,00€
11149	63	1.32	4	12	45,00€
11150	65	1.35	-	8	55,00€
11151	67	1.49	4	12	57,00€
11152	70	1.49	4	12	57,00€

3/4" (90mmL)

LONGO

REF.	mm				€
13723	19	0.43	6	12	18,50€
13724	21	0.50	6	12	19,20€
13725	22	0.61	6	18	19,20€
13726	24	0.56	6	24	19,00€
13727	26	0.51	6	18	18,70€
13728	27	0.50	6	18	18,50€
13729	29	0.70	6	12	22,00€
13730	30	0.70	6	24	22,00€
13731	32	0.71	6	24	21,60€
13732	33	0.75	6	24	23,80€
13733	34	0.85	6	18	24,90€
13734	35	0.80	6	18	25,70€
13735	36	0.81	6	12	25,80€
13736	38	0.83	6	18	25,90€



1"

REF.	mm				€
11624	65	2.40	1	2	189,00€
11625	85	5.35	1	2	282,00€
12984	105	5.00	1	2	379,00€

1/2" (78mmL)

LONGO

REF.	mm				€
14738	10	0.15	10	100	5,50€
14739	11	0.15	10	100	5,50€
14740	12	0.16	10	100	5,55€
14741	13	0.15	10	100	5,55€
14742	14	0.15	10	100	5,55€
14743	16	0.14	10	100	5,15€
14744	17	0.18	10	50	5,35€
14745	19	0.22	10	50	6,25€
14746	21	0.24	10	50	6,40€
14747	22	0.27	10	50	7,10€
14748	24	0.30	10	50	8,30€
11613	27	0.35	10	20	11,00€
11614	30	0.40	6	24	13,00€
11615	32	0.45	6	24	14,20€
11616	33	0.44	6	12	18,10€
11617	34	0.42	6	24	18,70€
11618	35	0.48	6	18	18,80€
11619	36	0.47	4	48	19,50€

52914 223,00€



CHAVE DE EXTRAÇÃO DE CASTILHO BPW 120MM DR.41MM



120mm
8 CANTOS
CUADRADO HEXAGONAL 41mm

52915 199,00€



CHAVE DE EXTRAÇÃO DE CASTILHO BPW 111MM DR.41MM



111mm
OVAL
CUADRADO HEXAGONAL 41mm

52916 218,00€



CHAVE DE EXTRAÇÃO DE CASTILHO BPW 109MM DR.41MM



109mm
8 CANTOS
CUADRADO HEXAGONAL 41mm

52917 122,00€



CHAVE DE EXTRAÇÃO DE CASTILHO BPW 65MM



65mm
OVAL
DIAGONAL 36MM

52918 146,00€



CHAVE HUBCAPS EIXO TRASEIRO BPW 95MM



95mm
CUADRADO 3/4"

52919 181,00€



CHAVE NUT RODA BPW 110MM 3/4"



110mm
8 CANTOS
CUADRADO 3/4"

52920 155,00€



CHAVE EXTRAÇÃO ROLAMENTIOS EIXO BPW 80MM 3/4"



80mm
CUADRADO 3/4"

52921 117,00€



CHAVE EXTRAÇÃO NUT EIXO TRASEIRO BPW 65MM 3/4"



65mm
CUADRADO 3/4"

52922 180,00€



CHAVE EXTRAÇÃO PORCA ROLAMENTOS EIXOS BPW 85MM 3/4"



85mm
6 CANTOS
CUADRADO 3/4"

52923 59,00€



CHAVE EXTRAÇÃO NUT SUSPENSÃO SCANIA 28X37MM 3/4"



28x37mm
CUADRADO 3/4"

52924 52,00€



CHAVE EXTRAÇÃO EIXO SUSPENSÃO SCANIA 34X46MM 3/4"



34x46mm
CUADRADO 3/4"

52925 176,00€



CHAVE RODA DIANTEIRA SCANIA 80MM H41



80mm
8 CANTOS
CUADRADO HEXAGONAL 41mm

52926 201,00€



CHAVE EXTRAÇÃO RODA NUT SCANIA 100MM 3/4" 8 CANTOS



100mm
8 CANTOS
CUADRADO 3/4"

52927 59,00€



CHAVE AMORTECEDOR TRASEIRO SCANIA 34X56MM 3/4"



34x56mm
CUADRADO 3/4"

52928 172,00€



CHAVE RODA DIANTEIRA SCANIA 80MM 3/4" 8 CANTOS



80mm
8 CANTOS
CUADRADO 3/4"

52929 185,00€



CHAVE DE PORCA DE RODA SCANIA 95MM 3/4" 8 CANTOS



95mm
8 CANTOS
CUADRADO 3/4"

FERRAMENTAS DE IMPACTO

52930 117,00€



INSTALADOR PARA VIRABREGUIM TRASEIRO RETENTOR ÓLEO SCANIA



SCANIA 310/320
RETENTOR 0366303-R

52931 45,00€

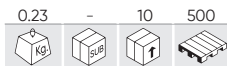

CHAVE CAMINHÃO SCANIA ROTAÇÃO EIXO DE COMANDO 1/2"



CUADRADO 1/2"

52932 45,00€

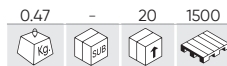

CHAVE PARA VÁLVULA DE INJEÇÃO ELECTROMAGNÉTICA SCANIA 38MM 1/2"



Ø38mm
CUADRADO 1/2"

52933 194,00€

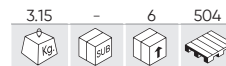

CHAVE 8 ALMENAS SCANIA 420



Ø11,6mm - Ø10mm
8 ALMENAS
CUADRADO 3/4"
SCANIA 420

53430 286,00€



CHAVE DE BUCHA PARA IVECO



Ø134mm - Ø110,5mm
118x134mm
IVECO
12 FACES

52935 94,00€

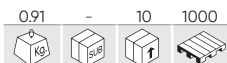

CHAVE DE PORCA DE CAMINHÃO BENZ/MAN 60MM



60mm
CUADRADO 3/4"

52936 199,00€

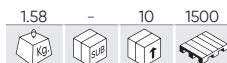

CHAVE EIXO TRASEIRO CAMINHÃO BENZ/MAN 80-95MM



80-95mm
CUADRADO 3/4"
6 ALMENAS

52937 265,00€



CHAVE EXTRAÇÃO HUB TRASEIRO CAMIÓN BENZ / MAN 95-115MM



95-115mm
CUADRADO 3/4"
6 ALMENAS

52938 199,00€



CHAVE EXTRAÇÃO EIXO DIREÇÃO BENZ / MAN



100mm
CUADRADO 3/4"
6 ALMENAS

52939 28,00€



CHAVE PARA EXTRAÇÃO DE VÁLVULA DE INJEÇÃO DIESEL BENZ/MAN



22-28mm
CUADRADO 1/2"
4 ALMENAS

52940 235,00€

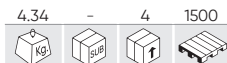

CHAVE PARA NUT DIFERENCIAL TRASEIRO BENZ/MAN



101mm
CUADRADO 3/4"
6 ALMENAS

52941 70,00€

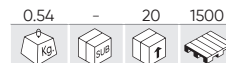

CHAVE ROTAÇÃO VOLANTE DO MOTOR BENZ E MAN 2 ENGRENAGENS



CUADRADO 1/2"

52942 105,00€



CHAVE ROTAÇÃO VOLANTE BENZ Y MAN 3 ENGRENAGENS



CUADRADO 1/2"

52943 75,00€



CHAVE ROTAÇÃO VOLANTE DE MOTOR MAN



CUADRADO 1/2"

52934 102,00€

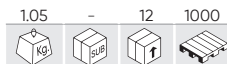

CHAVE PORCA HUB PARAFUSOS CAMINHÃO BENZ/MAN 56MM



56mm
CUADRADO 3/4"

REF.	mm			€
52944	30	1.00	20	110,00€
52945	39	2.74	24	281,00€

EXTRACTOR DE CABEÇA DE CAMINHÃO



52944
CUADRADO HEXAGONAL
19mm

52945
CUADRADO HEXAGONAL
26mm

CARROÇARIA

- 180 FERRAMENTAS PARA CARROÇARIA
- 183 RESTAURAÇÃO DE FARÓIS
- 185 SUBSTITUIÇÃO DE VIDRO
- 186 REPARAÇÃO DO CHASSIS
- 188 MOBÍLIA AUXILIAR
- 191 MANUTENÇÃO INTERIOR



53224

142,00€



KIT REPARADOR DE AMOLGADELAS

32 PCS AUDI

REPOSIÇÕES DISPONÍVEI

REF.	DESCRIÇÃO					€
13842	SACO DE 5 DISCOS AZUIS PARA REF. 53224	0.15	10	100	-	8,50€
13843	SACO DE 4 DISCOS AMARELOS PARA REF. 53224	0.01	10	100	-	7,00€
13844	SACO DE 10 DISCOS VERMELHOS PARA REF. 53224	0.05	10	50	-	9,00€
13845	SACO DE 5 BARRAS DE COLA PARA REF. 53224	0.02	10	100	-	8,00€



52876

182,00€



KIT ENCONTRADORES PARA CHAPEIROS 7 PCS

REPOSIÇÕES DISPONÍVEI

REF.	DESCRIÇÃO					€
A 12955	ENCONTRADOR TIPO BIGORNA	0.28	-	25	99	27,80€
B 12956	ENCONTRADOR TIPO TRILHO	0.31	-	25	99	27,80€
C 12957	ENCONTRADOR TIPO DUPLA FACE	0.37	5	25	99	27,80€
D 12958	ENCONTRADOR TIPO PUNHO COM CABEÇA CONVEXA	0.41	-	25	-	27,80€
E 12959	ENCONTRADOR TIPO VIRGULA	0.30	5	25	99	27,80€
F 12960	ENCONTRADOR TIPO CALCANHAR	0.18	-	25	1500	27,80€
G 12961	ENCONTRADOR TIPO VIRGULA CON MANGO	0.34	-	25	-	27,80€



51131

61,00€

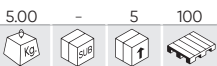

KIT ENCONTRADORES E MARTELOS PARA CHAPEIROS

REPOSIÇÕES DISPONÍVEI

REF.	DESCRIÇÃO					€
A 11541	MARTELO BOCA PLANA	0.43	5	25	-	11,00€
B 11542	MARTELO BOCA PLANA/PEÑA	0.38	5	25	-	11,00€
C 11543	MARTELO BOCA PLANA CÔNICA	0.42	5	25	-	11,00€
D 11544	ENCONTRADOR TIPO CALCANHAR	0.69	5	25	-	7,00€
E 11545	ENCONTRADOR TIPO CARRIL	0.79	5	25	-	11,00€
F 11546	ENCONTRADOR DUPLA EXTREMIDADE	0.81	5	25	-	12,00€
G 11547	ENCONTRADOR TIPO VIRGULA	0.81	5	25	-	12,00€



53545

35,70€

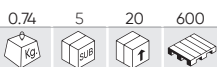

CAIXA DE 5 CHAVES DE CABEÇAS HEXAGONAIS ALONGADAS 3/8"

5 PCS 3/8"

BMV, FORD, OPEL, VAG, VAUXHALL CrV



8, 10, 12, 13, 14mm (120mmL)

51832 18,00€

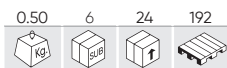

JOGO DE 4 ALAVANCAS DE NYLON TIPO FACA



19mm x 273mm
22mm x 273mm
25mm x 273mm
38mm x 273mm



50903 30,80€



JOGO DE 5 ALAVANCAS DE FERRO



60, 43, 38,
28, 18cm



52026 31,80€

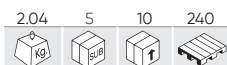

JOGO DE 2 ALAVANCAS DE FERRO

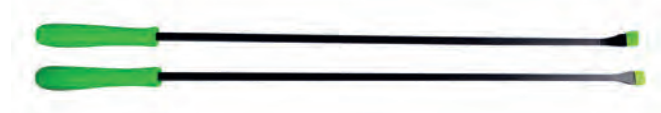

51360 8,05€



PÉ DE CABRA 18" X 5/8

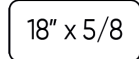

51361 9,80€



PÉ DE CABRA 24" X 3/4

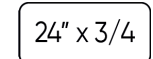

52851 9,65€



JOGO DE 2 ALAVANCAS PARA EXTRAÇÃO DE GRAMPOS

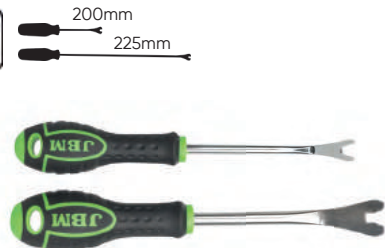

53110 27,30€



KIT DE 6 ALAVANCAS



5"x8.5mm
5"x10.3mm
5"x4.5mm
15"x8.5mm
15"x10.3mm
15"x4.5mm

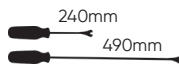

50901 16,00€

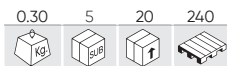

JOGO DE 5 ALAVANCAS DE NYLON



UNIVERSAL
60x160mm
63x175mm
30x200mm
20x180mm
20x215mm



52788 39,00€

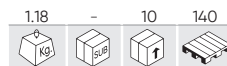

KIT DE 27 ALAVANCAS DE NYLON



CARROÇARIA

52977

137,00€

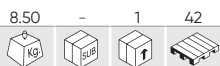

KIT DE 4 ALAVANCAS EXTRALARGAS



52540

221,00€



VENTOSA PNEUMÁTICA COM MARTELO DESLIZANTE

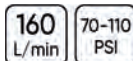

54017

12,00€



FERRAMENTA DE VEDAÇÃO DE SILICONE



INCLUI CINCO ALMOFADAS DE SILICONE DE REPOSIÇÃO: 3R, 6R, 10R, 13R, 17R



52533

10,00€



PISTOLA SILICONE 300ML



53525

12,00€



GRAMPO PARA ABRIDORES DO CAPÔ E PORTA-MALAS



- Diâmetro de abertura máximo: 10mm.

53655

12,00€



CHAVE PARA MAÇANETAS VAG



54246

104,00€

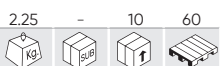

BALANÇA DE PRECISÃO DE 5KG

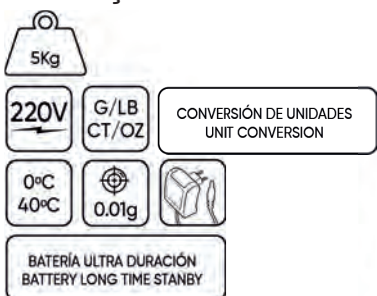

54247

99,00€



BALANÇA DE PRECISÃO DE 2KG

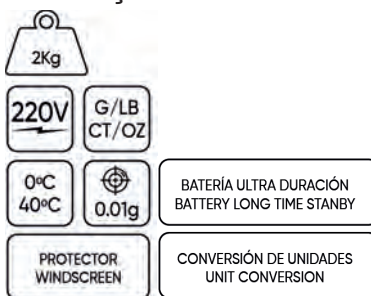

53230

19,70€

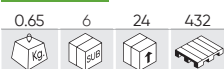

JOGO DE UTENSÍLIOS PARA ABRIR CARROS



52077

29,50€



JOGO DE 4 ALMOFADAS INFLÁVEIS

40-50mm

CONTÉM

Almofada de 16x16cm
Almofada de 32x12cm
Almofada de 19x6cm
Almofada de 18x4,5cm
Bomba manual

- Pressão máxima suportada: 100kg



53486

29,30€



ECRÃ PARA INSPEÇÃO DE AMOLGADELAS

Ø 800mm

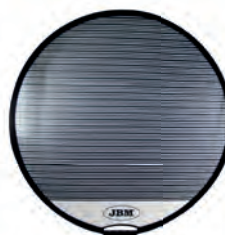

53673

80,00€

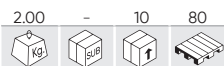

KIT DE RESTAURAÇÃO DE FARÓIS

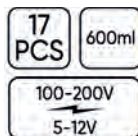

15375

28,00€

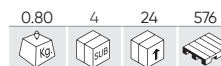

GARRAFA COM LÍQUIDO PARA REF. 53673

O kit de reparo de faróis de polímero líquido é um sistema inovador para restaurar os faróis queimados até a sua condição original com um brilho original e uma aparência perfeita.



UFI: 9600-WOPH-M003-4PRX

BRILHO ORIGINAL E UMA APARÊNCIA PERFEITA

REPOSIÇÕES DISPONÍVEI

REF.	DESCRIÇÃO	kg	SUB	QTD	€
A	14564 KIT DE 6 PAPÉIS ABRASIVOS PARA REF. 53673	0.10	10	100	9,20€
B	14565 ADAPTADOR AC-DC PARA REF. 53673	0.20	10	50	26,70€
C	14566 ADAPTADOR 12V PARA REF. 53673	0.05	10	100	16,70€
D	14567 COPO DE EVAPORAÇÃO PARA REF. 53673	0.15	10	20	38,00€
E	14568 TAMPA CURVADA COM ANEL DE VEDAÇÃO DE BORRACHA PARA REF. 53673	0.01	10	200	9,20€
F	14569 TAMPA PLANA COM ANEL DE VEDAÇÃO DE BORRACHA PARA REF. 53673	0.00	10	200	9,20€
G	14570 FUNIL PARA REF. 53673	0.01	10	200	4,05€
H	14571 PLACA DE MOAGEM PARA REF. 53673	0.05	-	10	9,20€
I	14573 PAPEL TEXTURIZADO PARA REF. 53673	0.01	10	100	4,05€
J	15375 GARRAFA COM LÍQUIDO PARA REF. 53673	0.80	4	24	28,00€

CONJUNTO DE 10 ELEMENTOS DO PAPEL ABRASIVO

REF.	DESCRIÇÃO	kg	SUB	QTD	€	REF.	DESCRIÇÃO	kg	SUB	QTD	€
14710	GRÃO 180	0.25	10	100	3,50€	14713	GRÃO 600	0.15	10	100	4,25€
14711	GRÃO 280	0.20	10	100	3,75€	14714	GRÃO 800	0.15	10	100	4,50€
14712	GRÃO 360	0.20	10	100	4,00€	14715	GRÃO 1200	0.10	10	100	4,75€



VÍDEO TUTORIAL

52740

690,00€

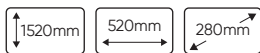
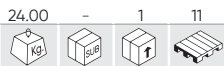

ALINHADOR DE FARÓIS COM LUXÓMETRO 152CM



HALÓGENO / XENON / LED

- Distância de medição: 50cm.
- Fácil medição de desvio do eixo óptico dos médios e dos máximos.
- Guias laterais opcionais.
- Também para caminhões.

52836

1.100,00€

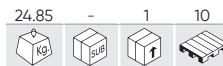

ALINHADOR DE FARÓIS COM DUPLO LASER E LUXÓMETRO



HALÓGENO / XENON / LED

- Também para caminhões.

DUPLO LASER
LUXÓMETRO DIGITAL
REGULAMENTO ECRÃ DE VERIFICAÇÃO

53626

18,00€

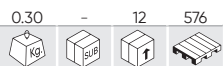

KIT DE RESTAURAÇÃO DE FARÓIS



CONTÉM

- | | | | |
|--|------------------------------|--|-----------------------------|
| | x2 EP800 Discos de lixar | | x1 85gm Pasta de polimento |
| | x2 P1200 Discos de lixar | | x1 Fita adesiva |
| | x2 P2000 Discos de lixar | | x1 Disco de polimento de lã |
| | x2 3.0ml Líquido protetor UV | | x1 Disco de Esponja Branco |
| | x2 Adaptador (3/8" & 1/4") | | |

EM EXPOSITOR DE 12 UDS



SERIE262

199,00€

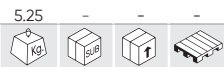

KIT ESPECIAL POLIMENTO: MÁQUINA POLIMENTO NEUMÁTICA + 12 KIT RESTAURAÇÃO DE FARÓIS

53626

x12u.



53646

x1u.



53729

19,10€

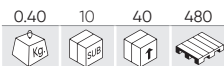

KIT DE FERRAMENTAS PARA AJUSTAR FARÓIS

H6, H7, T25



52262

7,50€

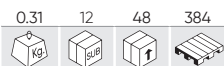

VENTOSA ÚNICA Ø 115MM

40Kg
ø 115mm



52263

13,50€

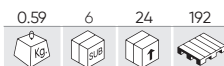

VENTOSA DUPLA - Ø 115MM

70Kg
ø 115mm



52264

18,60€

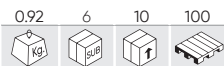

VENTOSA TRIPLE Ø 115MM

100Kg
ø 115mm



52265

30,50€

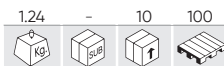

VENTOSA QUADRÚPLA Ø 115MM

120Kg
ø 115mm



52295

6,50€

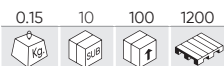

KIT DE DUAS MINI VENTOSAS Ø 60MM

5Kg
ø 60mm



52765

21,70€

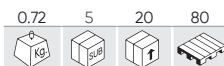

VENTOSA DUPLA ARTICULADA Ø 120MM

80Kg
ø 120mm



52998

48,00€

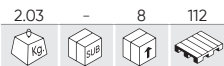

JOGO DE VENTOSO E CATRACA 5M X 25MM

80Kg
ø 120mm
5x25mm



53232

39,00€

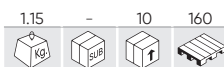

FERRAMENTAS PARA SUBSTITUIÇÃO DE PARA-BRISAS

7 PCS

CONTÉM
1x útil extrator de molduras.
1x alavanca para extrair a borracha.
1x gancho extrator.
1x 1.8m de fio de corte.
2x cabos para o fio de corte.
1x Passa-cabos.



13813

7,00€



CABO PARA EXTRAÇÃO DE PÁRA-BRISAS

PARA REF. 53232



13814

11,00€

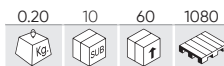

FERRAMENTA PARA EXTRAÇÃO DE PÁRA-BRISAS

PARA REF. 53232



CARROÇARIA

52321 8,80€



CINTA DE APERTO POLIÉSTER COM TENSOR 5M X 25MM

5mx25mm



52327 12,00€



CINTA DE APERTO POLIÉSTER COM TENSOR 8M X 25MM

8mx25mm

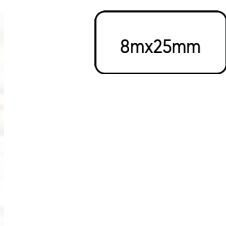

50577 12,60€



ALICATE DE PRESSÃO

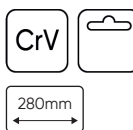

52386 23,60€

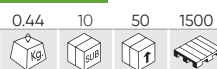

MORDAÇA DE PRESSÃO CURVADO - LISO



52385



JOGO DE 6 ALICATES DE MORDAÇA

W (195mm)



JJ (195mm)



LL (195mm)



J (210mm)



T (215mm)



L (225mm)



251,00€



MORDAÇA DE PONTAS

REF.	DESCRIÇÃO							€	
53675	MORDAÇA DE PONTAS DIRETAS	10"	250mm	70mm	0.75	10	20	300	50,00€
53676	ALICATE DE PONTAS CURVAS	10"	250mm	90mm	0.85	10	20	300	44,00€
53677	ALICATE DE PONTAS CURVAS E ALMOFADA GIRATÓRIA	10"	250mm	80mm	0.90	10	20	300	55,00€
53678	ALICATE DE PONTA CURVA LONGA	10"	300mm	105mm	0.90	10	20	300	52,00€



53675



53676



53677



53678



EM EXPOSITOR DE 10 UDS

52982







JOGO 3 MORDAÇAS DE PRESSÃO EXTRA-LARGAS



53,00€

MORDAÇAS

REF.	DESCRIÇÃO	mm	MATERIAL		T					€
52390	MORDAÇA ESPECIAL SOLDADURA	250mm	CrMo	-	-	0.50	5	40	640	35,20€
52474	MORDAÇA DE ARGOLA 5T	190mm	Aço	0-20mm	5T	3.49	-	5	1500	68,00€
52475	MORDAÇA PLANO 3T	170mm	Aço	0-25mm	3T	3.60	-	10	1500	62,00€
52476	MORDAÇA QUADRADO 5T	220mm	Aço	0-25mm	5T	3.10	-	10	1500	50,00€
52477	MORDAÇA DE MOLA 2T	200mm	Aço	0-60mm	2T	2.65	-	6	1500	70,00€
52478	MORDAÇA 90° 5T	170mm	Aço	0-20mm	5T	2.90	-	10	1500	49,00€
52479	MINI MORDAÇA PLANO 90° 3T	155mm	Aço	0-20mm	3T	1.18	-	30	1500	24,70€
52480	MINI MORDAÇA QUADRADA 90° 3T	210mm	Aço	0-25mm	3T	2.00	-	10	1500	44,00€
52481	MORDAÇA QUADRADA 3T	220mm	Aço	0-20mm	3T	2.05	-	10	1500	52,00€
52482	MORDAÇA PLANO ÂNGULO 45° 5T	210mm	Aço	0-10mm	5T	2.13	-	8	1500	44,00€
52483	MORDAÇA PLANO MINI 5T	210mm	Aço	0-10mm	5T	2.02	-	12	1500	41,00€
52484	UNIÃO DE CORRENTES 3T	275mm	Aço	0-110mm	3T	1.19	-	11	1500	66,00€
52485	UNIÃO DE GANCHOS DE 4T	270mm	Aço	0-90mm	4T	1.17	-	30	1000	51,00€
52486	UNIÃO DE CORRENTES GANCHOS 3T	280mm	Aço	0-110mm	3T	1.21	-	11	1500	62,00€
52487	MORDAÇA DE MOLA 5T	220mm	Aço	0-20mm	5T	2.27	-	7	1000	63,00€
52502	MORDAÇA DE PRESSÃO PARA SOLDADURA	280mm	CrMo	0-110mm	-	0.84	10	30	540	31,40€
52503	MORDAÇA DE PRESSÃO PESCOÇO DE CISNE MAXILAR OSCILANTES	280mm	CrMo	0-105mm	-	0.85	10	30	540	32,50€
52504	MORDAÇA DE PRESSÃO TIPO U 9"	225mm	CrMo	0-50mm	-	1.14	-	30	480	27,60€
52505	MORDAÇA PESCOÇO DE CISNE	170mm	CrMo	0-40mm	-	0.27	36	72	2160	20,80€
52506	MORDAÇA PESCOÇO DE CISNE, MAXILAS OSCILANTES	170mm	CrMo	0-50mm	-	0.28	36	72	2160	16,00€
52507	MORDAÇA DE PRESSÃO PARÁGRAFO LATOEIROS	250mm	CrMo	0-80mm	-	0.77	5	30	420	30,10€
52511	MORDAÇA PARA SOLDADURA 18"	440mm	CrMo	0-225mm	-	1.31	-	20	280	42,00€
52512	MORDAÇA DE PRESSÃO SOLDADURA, MAXILAS OSCILANTES	440mm	CrMo	0-210mm	-	1.31	-	20	280	50,00€



53983

215,00€

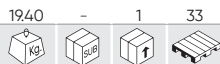

SUPORE DE PEÇAS - PÁRA-BRISAS E COBERTURA



12 HASTES DE 630 MM COBERTAS COM ESPUMA DE POLIETILENO EXPANDIDO (EPE)

ATÉ 5 GRANDES PAINÉIS OU VIDROS

RODAS DE POLIURETANO (PU) 4 "X 4" (DUAS GIRATÓRIAS COM FREIO)

53125

477,00€

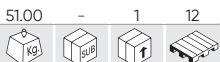

CARRO PARA ARMAZENAGEM DE PEÇAS



x4 INCLUÍDO

53124

287,00€



MEDIDAS ALTO



MEDIDAS LONGA



CAVALETE UNIVERSAL TELESCÓPICO



50923

454,00€



CARRO TRANSPORTADOR ESP. CHAPEIROS



- Separação de 0 a 110 cm.

REF.	DESCRIÇÃO	KG	BOX	BOX	BOX	€
12022	RODA DE SUBSTITUIÇÃO P/50923	194	-	10	1500	33,70€



53080 99,00€



CAVALETE PARA PARA-BRISA



70Kg

52749 79,00€

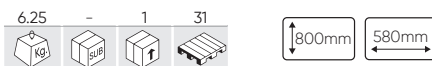

CAVALETE PROFESSIONAL



220Kg

53079 89,00€

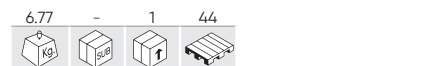

CAVALETE EN "X"



100Kg

MEDIDAS DESDOBRADO



MEDIDAS DOBRADO



REF.	DESCRIÇÃO	Kg	Box	€
11959	FOAM PARA PREGUIÇA REF. 52749	0.08	100	10,50€

53736 98,00€



CAVALETE SUPORTE PARA-CHOQUES



A LARGURA AJUSTÁVEL PERMITE QUE O SUPORTE SEJA ADEQUADO PARA SUPORTAR VÁRIOS TIPOS E ESTILOS DE PÁRA-CHOQUES

LARGURA AJUSTÁVEL: 75 CM -160CM

ALTURA MÁXIMA: 148CM

AÇO

53685 310,00€



SUPORTE PARA PARACHOQUE



AJUSTE DOS BRAÇOS DE SUPORTE DE 134 - 198CM

4 RODAS DE 4 POLEGADAS (DUAS GIRATÓRIAS COM TRAVÃO)

AÇO COM COBERTURA DE PÓ

53134 144,00€



SUPORTE PARA PINTURA AJUSTÁVEL



150Kg

- 6 ganchos para segurar peças para pintar ou secar.
- Marco ajustável que se estende de 127 cm a 203 cm.

53126 243,00€



SUPORTE BASCULANTE PARA PINTURA

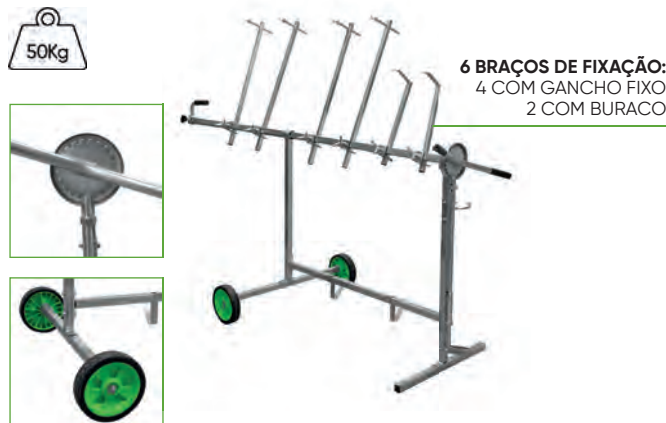

50Kg

6 BRAÇOS DE FIXAÇÃO:
4 COM GANCHO FIXO
2 COM BURACO

52230

398,00€

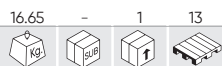

PLATAFORMA DE ALUMÍNIO TELESCÓPICA

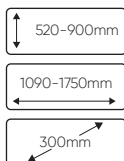

REF. DESCRIÇÃO

REF.	DESCRIÇÃO	KG	SUB	QTD	PALETE	€
10964	PROTECTOR DE ESQUINAS PARA PLATAFORMA COM REF. 52230	0.01	-	1	-	9,00€
10965	TIPO DE ESCADA PARA PLATAFORMA COM REF. 52230	0.01	-	1	-	6,00€
10966	PÉ DE RECAMBIO PARA PLATAFORMA COM REF. 52230	0.06	-	1	-	13,50€

CUMPRE COM: EN 131

50913

195,00€

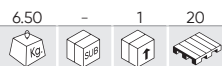

PLATAFORMA DE ALUMÍNIO GRANDE



CUMPRE COM: EN 131

50656

290,00€



JOGO 2 PLATAFORMAS DE ALUMÍNIO



CUMPRE COM: EN 131

REF. DESCRIÇÃO

REF.	DESCRIÇÃO	KG	SUB	QTD	PALETE	€
11897	100x30x30cm	4.66	-	1	16	155,00€
15552	130x30x55cm	6.80	-	1	18	181,00€

53922

29,00€



SUPORTE DE PAPEL PARA PAREDE

- Aço inoxidável
- Rolo: max. largura 38 cm
- Braçadeira-plástico ABS, cinzento.
- Parafusos e porcas de fixação em aço inoxidável.

PAPEL NÃO INCLUSO

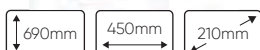

53921

39,00€



PORTA ROLO DE PAPEL

- Material: aço inoxidável
- Roll: max. largura 38 cm
- Braçadeira - plástico ABS

PAPEL NÃO INCLUSO



KIT SUPORTE + MATERIAL DE CUIDADO DO VEÍCULO

50400 168,00€

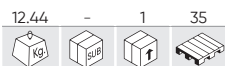

CONTÉM

- 53705 SUPORTE DE PAREDE
- 51978 ROLO COBRE ASSENTOS
- 52057 ROLO DE FILM PARA VOLANTE
- 52058 CABO PARA ROLO DE FILM
- 50409 TAPETE ANÔNIMO EM PAPEL

50403 98,00€

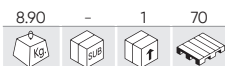

CONTÉM

- 52065 SUPORTE DE PAREDE
- 51978 ROLO COBRE ASSENTOS
- 52057 ROLO DE FILM PARA VOLANTE
- 52058 CABO PARA ROLO DE FILM

50410 168,00€



CONTÉM

- 53705 SUPORTE DE PAREDE
- 52244 ROLO COBRE ASSENTOS
- 52057 ROLO DE FILM PARA VOLANTE
- 52058 CABO PARA ROLO DE FILM
- 50409 TAPETE ANÔNIMO EM PAPEL

EXP. PAREDE DE BOBINA COBREASSENTOS, ROLO VOLANTE E TAPETES PAPEL

53705 80,00€

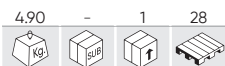

51985 84,00€

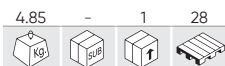

52065 45,00€



51978 84,00€



ROLO COBRE ASSENTOS 25MC 250U.



52244 84,00€



ROLO COBRE ASSENTOS DESENHO ANÔNIMO 25MC 250UD



52057 6,80€



ROLO DE FILM PARA VOLANTE

23 mc - Comp. 200m - Larg. 12,5cm - Grosso: 23mc

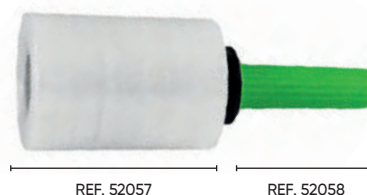

REF. 52057

REF. 52058

52058 4,50€



CABO PARA ROLO DE FILM COM REF. 52057

23 mc

CARROÇARIA

50409

26,00€

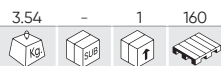

TAPETE ANÔNIMO EM PAPEL

250 PCS



51824

36,80€



PROTECTOR DE VOLANTE PLÁSTICO - 250UDS

250 PCS



50916

0.05 100 400 3200



KIT MANUTENÇÃO DE LIMPEZA EM BOLSA INDV.

5 PCS 20 mc



0,88€

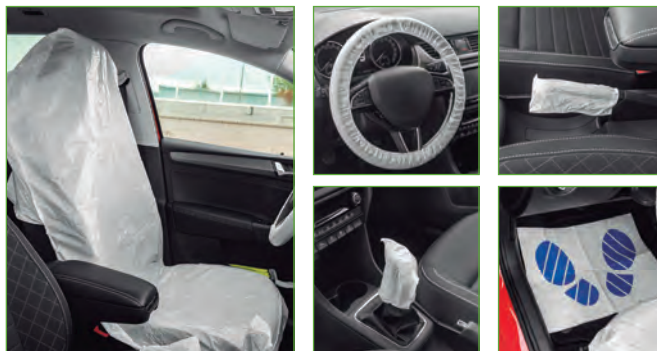

53226

14,90€

0.20 5 50 600



CAPA PARA ASSENTO DE CARRO



- NYLON.
- UNIVERSAL.

51622

25,30€

0.45 - 30 780



PROTECTOR MAGNÉTICO DE COBERTURA DE ALETAS E FACHADAS



4 PONTOS MAGNETIZADOS

DUAS FACES:
UM VELUDO / UM PLÁSTICO



CABO EXTENSÍVEL MULTIFUNÇÃO

REF.	Max.	Min.					€
52497	1200mm	530mm	0.29	6	48	480	26,80€
53196	1600mm	710mm	0.37	6	48	384	33,00€



TRAVÕES

194 REPOSICIONADORES

197 SANGRADORES DE TRAVÕES

197 MANUTENÇÃO



52636

114,00€

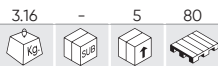

16 PCS

CONJUNTO DE RECOLHA DE EMBOLOS DE TRAVÕES PNEUMÁTICO

- 0 General Motors (Ø pistões 2-1/2 pol.)
- 2 Citroën XM/Xantia (F/R), HONDA
Audi (F), Fiat, Alfa romeo (F), Ford Fiesta (F), Isuzu (F), Honda Concesto (F), Jaguar XJ6/ XJ40 (F/R), BMW 318is / 320i / 325T / 518i / 525i-1x / 740i / 850ci / M5 (F), Mercedes BENZ 190/200/300/420/560 serie (F), Mitsubishi Colt (F), Nissan Miera/Stanza/Sunny (F), Rover Austin/Metro200-400 series/Maestra/Montego (F), Toyota Camry (F), Volvo (F), VW Passat/Golf GTI (F)
- 4 Ford Australia/NZ Telstar, Mazda (R), Saab 9000 (R)/Lumina, Toyota, Fiat 164 2.0 (R), Alfa Romeo Prelude/CRS 16i, Honda Saturn (R)/Grand Prix, GM
- 5 Adaptador 3/8"
- 6 Nissan Primera, VW Golf IV
Audi 80/90/V8+100/Coupe E (R), Rover 800 ABS, Subaru L+Z (R), Ford Sierra ABS/Granada/Scorpio ABS (R), Nissan Bluebird 1.8 Turbo/Silvia Turbo/Primera2.0i LS-GS-GSX (R), Peugeot 405 1.9Gi/Gri/Sri/Gtxi/Mi 16/605 2.0 Sri (R), Toyota Cecilia/Corolla GT/MR2 (R), VW Golf Gti/Jeta Synchron/Jetta Gti 16v, Passat CL, GL, GT, GT 16v, Corrado 16V scirocca GTX 16V(R), Citroën, Alfa romeo, Fiat, Honda, Jaguar, Renault, Saab, Seat, Lancia.
- 7
- 8 General Motors (pistões de 1-7/8 pol.)
- 9 General Motors (Ø pistões 2-1/8 pol.)
- A(Z) Renault (R21-Laguna (R))
- E Nissan Maximas/Cefiro
- F(G) Opel (Rear disk)/ Fiat Tilo
- K Citroën C5
- K1 Renault, Citroën C5

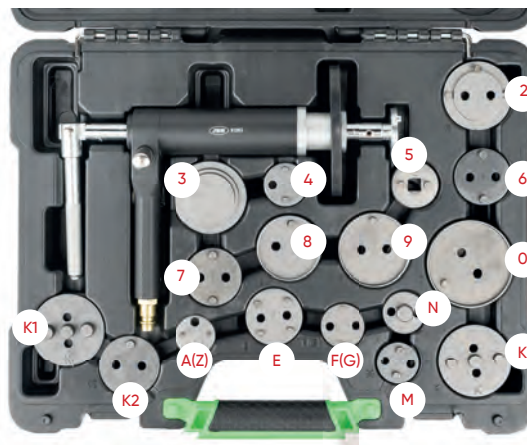

- K2 Renault, Citroën, Audi A8, S8
- M Ford, Mini Cooper, Nissan Primera 03
Saab, Honda, Alfa Romeo 164 2.0 Twin Spark/2.0 Turbo (88-)/3.0 V6, Audi 200 (80-)/Coupe GT SE (82-)/80/90/1QO/200/Quattro (87-)/90/20V (88-), Ford Mondeo 2.0/Ghia, Lancia Themaalte (85-), Volkswagen Golf II GTI (83-87)/Sirocco 16V (84)
- N

52330

99,00€



50 PCS OPEL PEUGEOT CITRÖEN RENAULT

CONJUNTO REPOSICIONADOR DE TRAVÕES

- 0 General Motors (Ø pistões 2-1/2 pol.)
- 1 Disco
- 2 Citroën XM, Xantia u.a.
- 3 Alfa Romeo,Audi, Austin, BMW, Ford, Honda, Jaguar, Mercedes-Benz. Mitsubishi, Nissan Rover, Toyota, VW
- 4 Alfa Romeo 164 2.0.Ford, Mazda, Saab 9000, Subaru
- 5 Adaptador 3/8"
- 6 Nissan Primera, VW-Golf IV
Audi 8.0,90,V8 +100, Ford Sierra ABS+ Scorpio ab 85, Honda Prelude, Nissan Silvia 1.8 turbo, Rover 8000, Saab 9000, Subaru L+Z, VW-Golf+ Passat
- 7
- 8 General Motors (pistões de 1-7/8 pol.)
- 9 General Motors (Ø pistões 2-1/8 pol.)
- 11 Disco para Tipo S
- 12 Disco para BMW mini
- A Nissan Premira 2.0, Bluebird
- A1 Ford Transit 06,Transit Connect 02,Tourneo Connect 02,Mondeo 00-07,C-Max 03, Focus 04
- B Ford, Lincoln, Subaru
- B1 Ford S-max 06,Scorpio 94-06,Mondeo 07,Kuga 08,Galaxy 00-06,Focus RS 03,Fiesta 01-02,Cougar 98-01
- C Nissan Primera (02), Opel Vectra 02-,Toyota Avensis
- D Citroën, Renault
- E Cefiro, Maxima
- F Peugeot 206 CC/Hdi/Gti. Ela exige uma chave de 16mm com pistões traseiros
- F1 Fiat Ducato
- G Opel
- G1 Volkswagon Golf V / VI
Alfa Romeo 155 1.8-2.0 164 TD(93) 164 3.0 V6(91), Audi 80,90,A3,A4,A6,A8, Citroen ZX 2 Ql 16V, Fiat Tipo TD 16V, Uno Turbo (85) Crama TD, Ford Sierra (ABS bak). Granada (85) Crama TD, Ford Sierra (ABS bak). (Australia& NZ) Thunderbird Turbo, Honda CRX, 1.6i-16V (8-90), Accord 1800 (84-85) 2.0i, Prelude 16V (88), Legend V6, Jaguar XJ 4, Oseries, Lancia Dadra 2.0, Ei Tur (93), Delta 1.6 Gti, Nissan, Peugeot, Renault, Seat, Subaru, Volvo V40 6S40.
- J
- K Citroën C5
- K1 Citroën
- K2 Citroën, Renault.
- M Ford
- N Saab, Honda
- O Disco

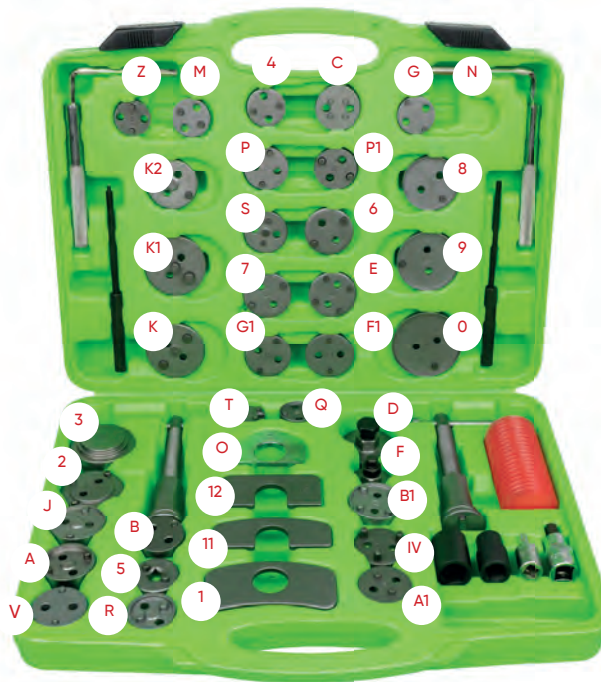

- P Audi, BMW, Ford, Lancia, Piston, Renault, Rover.
- P1 Peugeot 307,308.
Alfa Romeo 164 2.0 1., Fiat Uno, Turbo ie-Barchetta, Ford Escort MK III, IV, Orion, XR31, Focus(98-) push-back pistons, Honda-most models (push-back pistons), Rover-most models(push-back pistons), Subaru Lserie & Serie 2
Ford(Australia& NZ) Teslar, Laser, Mazda 323 Gti, GTXX (86), 929 (82.), RX7(81-), 626
R 16V(87-) 626 GT (86-), 929 V6 (88-), Mitsubishi Galant GL Si, Toyota Celica, Corolla GT, MR2
Audi 100 TQ(91), BMW 740i 8cyl (91), Lancia Delta 1.9 TD (95), Proton 416, Renault-most models, Renault Laguna 2.0 (94), Laguna 2.2 D (95) Safrane 2.0-2.2 TD V6, Rover 623 Si, Volkswagen Golf Gtu Mk I&IV, Passat VR6, Vento GT (92)
- S
- T Rover 220 C Turbo (95)
- V Rover 216 Gti 16V,820 Si 2.0(93),825 SD 2.5 (93)
- Z Renault
- IV Iveco Daily, Volkswagen Passat 2.0 TDI 09-

53978

38,90€

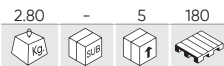

23 PCS

CONJUNTO DE REPOSICIONADOR DE TRAVÕES 23 PEÇAS

- 0 General Motors (Ø pistões 2-1/2 pol.)
- 1 Disco
- 2 Citroën XM, Xantia
- 3 Alfa Romeo, Audi, Austin, BMW, Ford, Honda, Jaguar, Mercedes-Benz, Mitsubishi, Nissan, Rover, Toyota, VW
- 4 Alfa Romeo 164 2.0, Ford, Mazda, Saab 9000, Subaru
- 5 Adaptador 3/8"
- 6 Nissan Primera, VW.Golf IV
- 7 Audi 80;90;V8+100, Ford Sierra ABS+Scorpio de 1985, Honda Prelude, Nissan Silvia 1.8 turbo, Rover 8000, Saab 9000, Subaru L+Z, VW Golf + Passat
- 8 General Motors (pistões de 1-7/8 pol.)
- 9 General Motors (Ø pistões 2-1/8 pol.)
- 10 VW
- K1 Citroën
- A Renault R21, Laguna
- K2 Citroën
- E Nissan Maxima, Cefiro
- M Ford
- F Opel
- N Saab, Honda
- K Citroën C5
- O Disco

J Fiat Tipo TD 16V, Uno Turbo(85) Crama TD, Honda CRX, Alfa Romeo 155 1.8-2.0i, 164 TD (93), 164 3.0 V6 (91); Audi 80, 90, & V8's, A3, A4, A6, A8 (pinza traseira); Citroën ZX 2. Ql 16v; Fiat Tipo TD 16V, Uno Turbo (85-), Crama TD; Ford Sierra (ABS bak), Granada (85-); Ford (Australia & NZ) Thunderbird Turbo; Honda CRX, 1.6i-16V (88-90), Accord 1800 (84-85), 2.0i (86-), Prelude 16V (88-), LegendV6; Jaguar XJ serie 40; Lancia Dedra. 2.0 Ei Tur(93), Delta 1.6 Gti. (92), The. majE 16v(92), Thema. 2000 Turbo. Kappa 2.Q-2.4LS, 2.4TD;

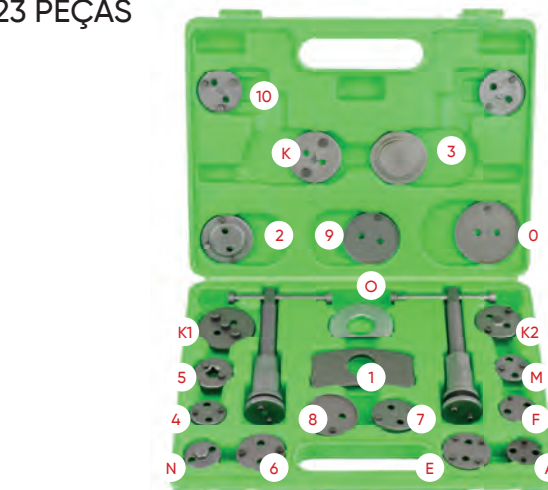

J Nissan 280 ZX (82-84), 300 ZX Turbo (84-89), Bluebird 16V (89-), Silvia 1.8 Turbo (85-88) 100 NZ 2.0 (93), Primera 2.0 GT (94), 200 SX turbo 16V, Maxima 2. O GX-3.0 GX (95); Peugeot 306; Peugeot 309 Gtj 16S (91), 405. Srif Q. rj, Gil (87-), 405 M.1 16v; Renault Master Van; Rover 216 Gti 16V, 820 Si 2. 0(93), 825 SD 2.5 (93); Saab 9000 CS 2.0(93), 9000 CSE Turbo(93); Seat Toledo GT. 16V-GT 2.0(93), Lbiza 1.8 Gti 16V(95); Subaru Lserie & Serie 2; Volkswagen Passat 2.0 & 2.2 Litre(84), Golf Rallye (-89), Golf II Gti 16V(89-), Vento GT (92), Transporter T4; Volvo S40 & V40

51059

99,00€



37 PCS

CONJUNTO REPOSICIONADOR DE TRAVÕES

- 0 Disco
- 1 Disco
- 2 Citroën XM, Xantia (F/R)
- 3 Alfa Romeo, Audi, Austin, BMW, Ford, Honda, Jaguar, Mercedes-Benz, Mitsubishi, Nissan, Rover, Toyota, VW.
- 4 Alfa Romeo 164 2,0,Ford,Mazada,Saab 9000,Subaru.
- 5 Adaptador 3/8"
- 6 Nissan Primera,VW-Golf IV.
- 7 Audi 80,90,V8 +100,Ford Sierra ABS+Scorpio ab 85,Honda Prelude Nissan Silvia 1.8 turbo,Rover 8000, Saab 9000, Subaru L+Z, VW-Golf +Passat.
- 8 General Motors (pistões de 1-7/8 pol.)
- 9 General Motors (Ø pistões 2-1/8 pol.)
- 11 Disco para Tipo S
- 12 Disco para BMW mini
- A Disco de dois pinos 1-3 / 16 " para Renault R21, Laguna
- B Ford, Lincoln, Subaru.
- C Mini Austin
- D Citroën, Renault.
- E Cefiro, Maxima
- F Opel Corsa, Astra, Zafiraand Vectra
- G Opel (disco traseiro)
- H Alfa Romeo 155 1.8-2.0 164 TD(93) 164 3.0 V6(91) Audi,80,90,A3,A4,A6,A8 Citroen ZX 2 Ql 16V,Fiat Tipo TD 16V,Uno Turbo(85) Crama TD, Ford Sierra(ABS bak),Granada (85),(Australia & NZ) Thunderbird Turbo,Honda CRX,1.6i-16V (8-90),Accord 1800(84-85)2.0i,Prelude 16V(88),Legend V6,Jaguar XJ40series,Lancia Dedra 2.0 Ei Tur(93),Delta 1.6Gti,Nissan,Peugeot,Renault,Seat,Subaru,Volvo V40& S40.

K Citroën C5
 K1 Citroën, Renault.
 K2 Citroën, Renault.
 M Ford
 N Saab,Honda. Z: Renault
 O GM Motors.
 P Audi, BMW, Ford, Lancia, Proton, Renault, Rover, VW
 R Ford (Australia & NZ) Telstar,Laser, Mazda 323 Gti,GTX(86-),929(82-),RX7(81-),626 16V (87-), 626 GT (86-),929 V6(88-),Mitsubishi Galant GL Si, Toyota Celica,Corolla GT,MR2. Audi 100TQi(91), BMW 740i 8cyl.(91), Lancia Delta 1.9 TD(95), Proton 416, Renault-most models, Renault Laguna 2.0 (94), Laguna 2.2 D(95), Safrane 2.0-2.2 TD V6, Rover 623 Si, Volkswagen Golf Gti Mk 3&4,Passat VR6,Vento GT(92).



Z BMW, Mini
 Grampo de rotação direita (com rosca à direita)
 Grampo de rotação esquerda (com rosca à esquerda)
 Pin Ø 3.0 / Pin Ø5.5 (100g Grasa)

52906

38,00€

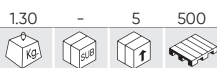

CONJUNTO DE REPOSICIONADOR DE TRAVÕES UNIVERSAL



REF. DESCRIÇÃO

REF.	DESCRIÇÃO	1.30	5	500	€	
12974	REPUESTO 2 PINOS PARA REF. 52906	0.50	-	50	1500	21,00€
12975	REPUESTO 3 PINOS PARA REF. 52906	0.17	-	50	-	23,00€

ALFA ROMEO 164 2.0, FORD, MAZDA, SAAB 9000, SUBARU, NISSAN PRIMERA, VW, AUDI, FORD SIERRA ABS + SCORPIO AB 85, HONDA PRELUDE, NISSAN SILVIA 1.8 TURBO, ROVER 8000, SAAB 9000, FORD, OPEL, BMW, LANCIA, PROTON, RENAULT, ROVER, PEUGEOT 307, 308 A3- IVECO DAILY, VOLKSWAGON PASSAT 2.0 TDI 09, RENAULT LAGUNA.

53683

116,00€

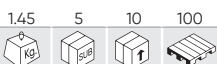

PISTOLA PARA POSICIONAR FREIOS - PERFIL BAIXO

- Pressão normal de uso: 5-8bar.
- Máxima de trabalho: 14bar.



51283

78,00€

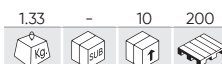

PISTOLA PARA POSICIONAR FREIOS

- Pressão normal de uso: 5-8bar.
- Máxima de trabalho: 14bar.



52191

198,00€

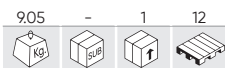

SANGRADOR DE TRAVÕES

5L

- Pressão de trabalho: de 0 a 4 kg/cm².
- Entrada e saída de 1/2".
- Peso: 5Kg.
- Adaptadores: T1 + 2 universales.
- Aplic.: GM, Chrysler, Nissan.



REF. DESCRIÇÃO

52328 TAMPAS PARA SANGRADOR DE TRAVÕES PARA REF.52191

2.90 - 4 64 99,00€

52434

125,00€

15
PCS

KIT PARA REPARAÇÃO DE TRAVÕES

- x2 Chaves para porcas de freio
- x1 Alicates de mola de freio
- x1 Chave de fenda de impacto
- x3 Soquetes de chave de fenda
- x1 Ferramenta de montagem
- x1 Chave de fenda com articulação universal
- x1 Ferramenta de freio especial
- x1 Escova de limpeza
- x1 Escova para limpeza de latão
- x1 Ferramenta de montagem
- x1 Alicates para cabo de freio
- x1 Arquivo de pinça de freio



54135

82,00€

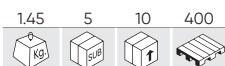
17
PCS

KIT DE CHAVES DE CAIXA PARA PINÇA DE TRAVÃO

CONTÉM

	x2	14x38, 22x38mm
	x3	11,50x38, 15x38, 20x38mm
	x4	10, 12.50, 14, 19mm
	x1	10mm
	x4	H11x100, H7x70, H7x92, H9x50mm
	x2	7x24, 8x24mm
	x1	9x20mm



AUDI (A4, A5, S5, S8, Q5, Q7), PORSCHE (CAYENNE, MACAN, CAYMAN), MERCEDES BENZ, FORD, BMW, ALFA ROMEO

54372

157,00€



N

CONJUNTO DE TESTADORES DE TRAVÕES COM E SEM ABS

Concebido para a desinstalação das pinças de travão para o processo de substituição dos calços do travão.

APLICAÇÕES

Audi (TT (2007-), A4 (2001-), A6 (2005-), A8 (2003-), Q7, S5, S6, S8), Porsche (Cayenne, Macan, Cayman), Mercedes-Benz (ML320, Classe C), Ford (Mondeo, Fiesta, Focus, Edge), BMW (Series 3 -generación E36 / 5), Alfa Romeo, Jaguar (XF), Vauxhall, Volkswagen, Chrysler, Mini, SAAB

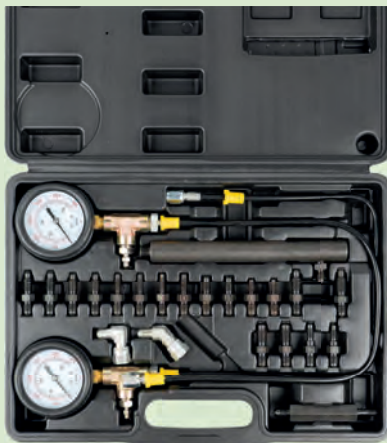

CONTÉM

- x1 Adaptador Teves
- x1 Encaixe Giratório de 45°
- x1 Encaixe Giratório de 90°
- x2 Encaixes Retos de 7/16-24 de polegada
- x2 Encaixes Retos de 1/4-28 de polegada
- x2 Encaixes Retos de 3/8-24 de polegada
- x2 Encaixes Retos de 5/16-24 de polegada
- x2 Encaixe Reto M10-1,5
- x2 Encaixe Reto M8-1,25
- x2 Adaptador de Drenagem M10-1,0
- x2 Encaixes Retos de 7/16-20 de polegada
- x2 Encaixe Reto M7-1,0

52625

9,00€

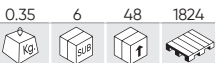

ALICATE PARA MOLAS DE TRAVÃO



- Para remoção e instalação de molas de retorno em freios a tambor.

52315

16,00€

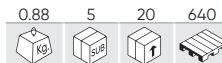

SEPARADOR DE EMBOLOS DE TRAVÕES



- Abertura máxima 80mm.

51839

24,00€

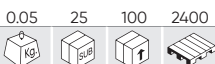

COMPROVADOR DE FLUÍDO DE FREIO

- Funciona com pilhas 1xAAA LRO3.
- Com 4 níveis de qualidade medíveis de 0% a 4%.



52455

16,00€

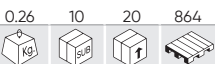

APALPA FOLGAS PARA PASTILHAS DE TRAVÕES

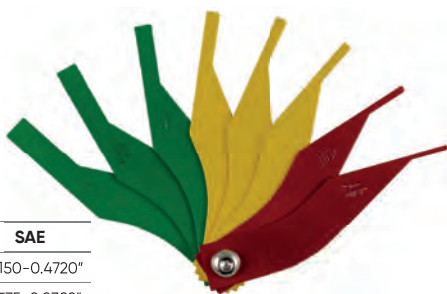

COLOR	METRIC	SAE
Green	8-10-12mm	0.3150-0.4720"
Yellow	4-5-6mm	0.1575-0.2382"
Red	2-3mm	0.0787-0.1181"

52275

38,00€



SANGRADOR DE TRAVÕES



- Temperatura de trabalho: 10 ° C la 50°C.
- Mangueira de silicone: 2m.
- Pistola da ar de entrada 1/4".
- Pres.: 6-12 bar (87 - 174 psi).
- Consumo de ar: 180l/min.

FERRAMENTA ESPECIAL

- 200 SISTEMA DE LUBRIFICAÇÃO
- 206 SISTEMA DE INJETORES
- 213 CILINDROS
- 216 EMBREAGEM
- 217 SISTEMA DE REFRIGERAÇÃO
- 219 SISTEMA DE AR CONDICIONADO
- 221 TRANSMISSÃO
- 223 SUSPENSÃO
- 229 ESCAPE
- 231 SISTEMA ELÉTRICO
- 235 REPARAÇÃO DE ROSCAS
- 238 MOTOS
- 238 EXTRATORES



54068

120,00€



KIT DE CHAVES PARA FILTROS DE ÓLEO DE ALUMÍNIO, 19 PÇS

REF.	Nº DE PEÇAS	DESCRIÇÃO	FACES x Ø				€
15494	05101	Mazda, Mitsubishi	15 x 100,5mm	0.18	-	50	12,50€
15495	0595	Nissan, Toyota	15 x 94,5mm	0.18	-	50	12,50€
15496	0592	Nissan, Subaru	15 x 92mm	0.18	-	50	11,50€
15497	0579	Toyota, Honda, Mitsubishi, Subaru, Mazda, Lsuzu	15 x 79mm	0.14	-	50	11,00€
15498	915	Volvo	16 x 87mm	0.24	-	50	11,50€
15499	901L	Lexus	14 x 79,5mm	0.15	-	50	11,00€
15500	901T	Toyota	14 x 70mm	0.13	-	50	10,00€
15501	901-1	Toyota	14 x 63-64mm	0.10	-	50	10,00€
15502	902	Ford, Mazda	14 x 66,5mm	0.89	-	50	10,00€
15503	1284	Dodge Sprinter (2007-), Mercedes Benz E320 (2007-), Jeep Cherokee 3.0L V6 Common Rail (2007-)	14 x 84mm	0.13	-	50	11,00€
15504	903B	Mercedes Benz	14 x 74mm	0.13	-	50	10,00€
15505	24mm	BMW 5, BMW 7, BMW X5 V8 (N62) (2004-), Saturn (2008), Astra 1.8L ECOTEC, Chrysler 3.6L V6 (2011-), 200, 300, T/C Dodge Jeep	6 x 24mm	0.47	-	50	4,00€
15506	27mm	Mercedes Benz Classe A	6 x 27mm	0.45	-	50	4,00€
15507	30mm	Audi A2, Vw Polo, Lupo 1.4L/1.6L	6 x 30mm	0.44	-	10	4,50€
15508	32,5mm	Opel Astra G, Corsa B, Zafira, Audi, VW 1-36 mm, Opel Omega, Vectra B, Zafira (98-), BMW M43/60)	6 x 32,5mm	0.45	-	50	4,50€
15509	36mm	Opel Omega, Vectra B, Zafira (98-), BMW M43/60, Mercedes Benz Vito CDI, C, E, VW Lupo 1.2 TDI, MAN	6 x 36mm	0.48	-	50	5,00€
15510	38mm	Opel Vectra 2.0D	6 x 38mm	0.50	-	50	5,00€
15511	917	Universal	55-90mm	0.22	-	50	8,00€



51332

98,00€



KIT DE EXTRACTORES PARA FILTROS OLEO

REF.	Nº DE PEÇAS	DESCRIÇÃO	FACES x Ø				€
11374	901	Toyota, Nissan, Fiat Daihatsu	14 x 65mm	0.05	5	20	5,50€
11375	902	Toyota, Daihatsu	14 x 67mm	0.45	5	20	6,50€
11376	903	VW, Mercedes, BMW, Opel, Audi	14 x 74mm	0.20	5	20	5,50€
11377	903-1	GM/AC, Wix, Ford, Isuzu	15 x 75mm	0.09	5	20	5,50€
11378	903-2	VW, Audi, Seat, BMW, Renault	8 x 74mm	0.09	5	20	6,50€
11379	903-3	Audi, Rover, Chrysler	15 x 74mm	0.11	5	20	6,00€
11380	903-4	Toyota, Lexus	14 x 73mm	0.11	5	20	6,50€
11381	903-6	Schlepper, Baumashinen	12 x 75mm	0.10	-	20	6,50€
11382	918	Rover, Chrysler, Audi	15 x 74mm	0.11	5	20	6,00€
11383	904	Nissan, Ford	15 x 79mm	0.50	5	20	6,00€
11384	905	GM, Chrysler	15 x 73mm	0.12	5	20	6,00€
11385	905-1	BMW, Mercedes, Opel, Audi, VW	14 x 74mm	0.10	5	20	5,50€
11386	906	Baumashinen, Schlepper	18 x 84mm	0.10	5	20	6,00€
11387	907	Mitsubishi, Toyota	15 x 89mm	0.13	5	20	6,00€
11388	908	Nissan, Toyota	15 x 91mm	0.14	5	20	6,00€
11389	915	Honda Accord, Mitsubishi, Isuzu	15 x 90mm	0.16	5	20	6,00€
11390	910	Toyota, Alfa Romeo, Ford	15 x 95mm	0.12	5	20	6,00€
11391	911	Fiat, Renault, Citroën	12 x 76mm	0.09	5	20	6,50€
11392	911-1	Subaru, Toyota, Honda, Nissan	15 x 80mm	0.09	5	20	6,00€
11393	914	Mazda, Toyota	15 x 101mm	0.18	5	20	6,00€
11394	909	Isuzu, Nissan	15 x 92mm	0.14	5	20	6,00€



REF.	DESCRIÇÃO				€
14992	CHAVE DE 12 VIAS PARA NO. 51332/NO. 14141	0.14	-	100	8,50€
10955	CATRACA 1/2" PARA EXTRATOR DE FILTRO 51332	0.14	-	50	11,00€

CHAVE EXTRAÇÃO PARA FILTROS DE ÓLEO

REF.	FACES x Ø	DESCRIÇÃO						€
52311	42mm	GRUPO VAG	0.13	6	72	1728		19,00€
52312	14 x 74mm	VW, OPEL, MERCEDES, BMW, AUDI	0.10	10	100	1000		9,00€
52313	16 x 86mm	VOLVO 540, 560, 570, 580	0.20	6	68	1008		8,00€
52314	16 x 87mm	BMW, VOLVO	0.20	5	50	600		26,60€
52809	14 x 64,5mm	TOYOTA	0.15	10	100	1000		8,50€
53441	14 x 76mm	-	0.20	5	20	800		9,80€



53008

15,50€

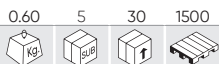

EXTRATOR PARA FILTRO OLEO FORD, CITROËN, PEUGEOT 2.0, 2.2 HDI, TDCI



52518

115,00€

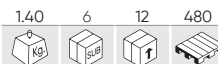

EXTRATOR DE FILTROS DE CAMION 95-165MM



52615

112,00€



EXTRATOR PARA FILTRO DE ÓLEO - 9 PEÇAS

9 PCS

- Chave de doble sentido ajustável.
- Rango de aplicação: 60-80mm.

1/2"	x1	Universal	63 - 83mm
		Mercedes Benz, Smart	27mm
	x3	GM, Opel, Vauxhall, Mercedes Benz	32mm
		Mercedes Diesel, BMW, Mini, Ford	36mm
		Toyota (Allion, Auris, Corolla, Prius, Voxy, etc.)	64,5mm
3/8"	x3	Toyota, Lexus (6 Zyl.).	64,5mm
		Audi, BMW, Ford, Toyota, Volkswagen, Porsche, Mercedes-Benz	74,2mm
	x1	Hunday, Kia.	88,8mm
	x1	BMW 3+5+X, Volvo	86,6mm



EXTRATOR FILTRO DE ÓLEO DE PATILHA PLANA / REDONDA

51352

9,80€



1/2" - 3/8"
57-118mm
Ø2-1/4" ~ 5"

51353

11,50€



1/2" - 3/8"
72-136mm
Ø2-1/2" ~ 4"

51923

12,50€



1/2" - 3/8"
72-136mm
Ø2-1/2" ~ 4"

51934

11,50€



1/2" - 3/8"
57-118mm
Ø2-1/2" ~ 4"

53206

38,20€



5
PCS

CONJUNTO DE 5 VARAS PARA VERIFICAR O ÓLEO - BENZ/AUDI

- Para verificar o fluido de transmissão de óleo nos motores audi 100:
 - Na ponta (os primeiros 11mm) é a leitura do fluido a frio 20 0 c.
 - A segunda leitura é no mínimo a 800 c.
 - A terceira leitura é a 800 c. no máximo.
- Mantenha o veículo a nível para verificar o atf.
- Vareta medidora para verificar o nível do óleo no motor. compatível com uma grande seleção de motores de 1988 a 2005 na gama mercedes.



	Mercedes-Benz	920mm	- Código de transmissão: 716.5,722.7,722.8.
	Mercedes-Benz	930mm	- Ano de fabrico: 1988-1997. - Códigos do motor: 103,104,111,119,120,137,604,605,606,611,612,613,628,642,647,648.
	Mercedes-Benz	930mm	- Ano de fabrico: 1996-2005. - Códigos do motor: 103,104,111,112,113,119,120,137,271,272,604,605,606,611,612,613,628,642,646,647,648.
	Mercedes-Benz	1200mm	- Código de transmissão: 722.6.
	Audi	1160mm	- AUDI 100 motores.

REF.	DESCRIÇÃO					€
13856	VARETA PARA VERIFICAÇÃO DE ÓLEO AUDI	0.04	5	100	-	7,80€

51354

13,20€



PINÇA EXTRATORA DE FILTROS DE ÓLEO

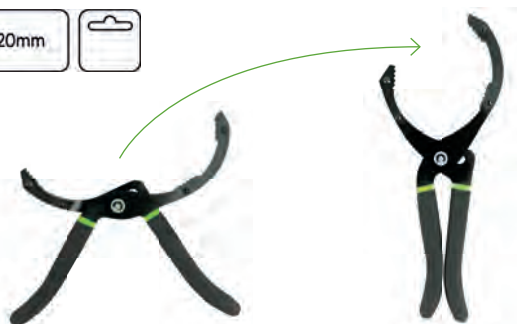

53670

29,50€



CHAVE DE FILTRO DE ÓLEO PARA VAG DSG 1/2" 24 MM



- Conjunto de ferramentas para reparar e recondicionar os parafusos das rodas, bem como ancorá-lo à rosca fêmea do veículo; útil em roscas parcialmente danificadas.



52269

7,00€

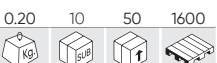

EXTRATOR DE FILTROS DE CINTA

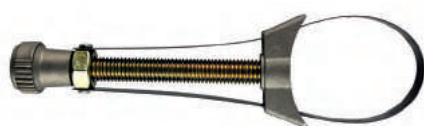

SUBSTITUIÇÃO

REF.	mm				€
11106	360mm	0.02	10	50	3,00€

52677

17,00€

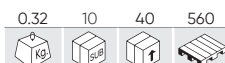

EXTRATOR FILTROS AJUSTÁVEL Ø65-105MM



SUBSTITUIÇÃO

REF.	mm				€
11936	383mm	0.15	5	300	4,00€

52678

18,00€

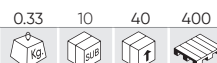

EXTRATOR DE FILTROS AJUSTÁVEL Ø110-155MM



SUBSTITUIÇÃO

REF.	mm				€
11937	540mm	0.04	10	100	5,00€

EXTRATOR DE FILTROS

52417 28,00€

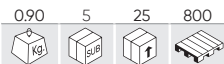

CADEIA DE ALTA RESISTENCIA

52416 14,00€

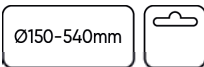
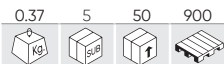

CORREIA DE POLÍMERO (ALTA RESISTÊNCIA)

52607 49,00€

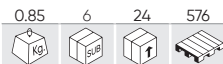

DOBLE CADEIA ARTICULADO

52608 44,00€

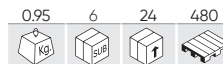

DOBLE CADEIA ARTICULADO

53735



KIT DE CHAVES PARA BUJÃO DE CARTER, 23PCS

CONTÊM

- x2 5/16", 3/8"
- x7 7, 8, 10, 11, 12, 13, 14mm
- x1 10mm
- x1 10mm
- x7 8, 9, 10, 12, 13, 14, 17mm
- x1 T45
- x1 M16

- x1 200mm
- x2 75, 150mm

44,00€

23 PCS 3/8"

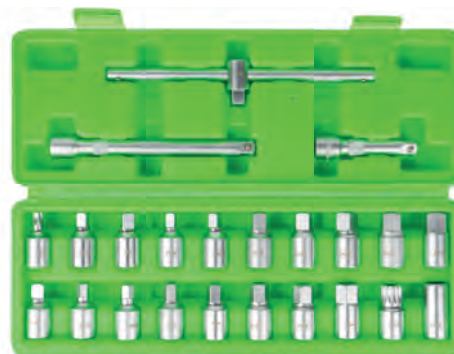

15084



MÓDULO DE EXTRAÇÃO DE TAMPÕES DE CÁRTER

CONTÊM

- x2 5/16", 3/8"
- x7 7, 8, 10, 11, 12, 13, 14mm
- x1 10mm
- x1 10mm
- x7 8, 9, 10, 12, 13, 14, 17mm
- x1 T45
- x1 M16
- x1 200mm
- x1 150mm



TAMBÉM ADEQUADO PARA COLETORES DE ÓLEO 53873 E 53874.

68,00€



KIT REPARADOR DE ROSCAS DE TAMPÃO CÁRTER

53235 10,40€



M13



53236 11,50€



M15



53237 12,90€



M17



53238 18,40€



M20



FERRAMENTA ESPECIAL

TAMPAS DE DRENAGEM DE ÓLEO

5
PCS

REF.	DESCRIÇÃO					€
13969	VAG	0.02	10	100	-	19,00€
53537	BMW	0.05	10	100	4000	14,50€
53538	Ford	0.10	10	100	4000	14,50€
53741	Ford / PSA	0.05	10	100	4000	14,00€



53472 12,00€

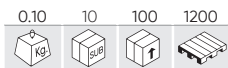

CHAVE PARA BUJÕES DE CARTER DE PLÁSTICO (VAG)



52617 7,00€

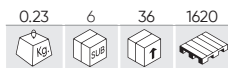

CHAVE QUADRADA PARA BUJÕES

- Para Citroën, Renault, Peugeot.



53473 36,00€

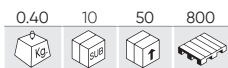

KIT EXTRATOR DE BUJÕES DE CÁRTER DE PLÁSTICO

5
PCS



A	x1	3/8"	80x100mm	Ford	OEM 1830727
B	x1	1/4"	1,5mm	VAG	OEM 06L 103 801
C	x1	1/4"	10mm	BMW	OEM 11137605018
D	x1	3/8"	3mm	Peugeot/Citroën	OEM 9801444780/OEM18711598
E	x1	1/4"	- 3/8"		

52754 54,00€

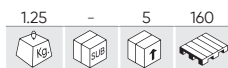

MEDIDOR DE PRESSÃO DE ÓLEO

0-10 BAR 0-140 PSI

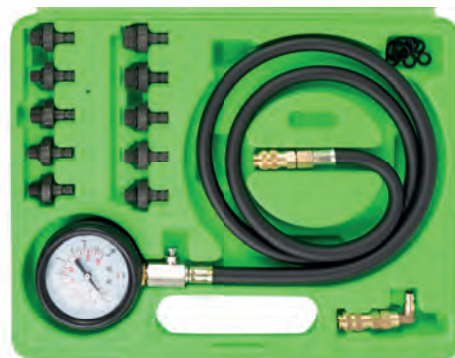

x1	M10x1.0mm
x1	M12x1.5mm
x1	M14x1.5mm
x1	M16x1.5mm
x1	M18x1.5mm
x1	1/8" DIN 2999
x1	1/8" x 27 NPT
x1	1/4" x 18 NPT
x1	3/8" x 20 UNF
x1	1/2" x 20 UNF

51337 50,00€

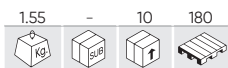

KIT DE REPARAÇÃO DE BUJÕES DE CARTER

24
PCS

- Bujões de SKS3.
- Machos de 1015.
- Anilhas de Cobre.

CONTÉM

- M13x1,5P
- M15x1,5P
- M17x1,5P
- M20x1,5P
- Macho: 1 x medida.
- Bujões: 5 x medida.
- Anilhas: 10 x medida.

REPOSIÇÕES DISPONÍVEIS

	REF.	DESCRIÇÃO				€
	A 51400	M15 x 1.5P	0.15	50	100	17,00€
	B 51401	M17 x 1.5P	0.14	50	100	22,00€
	C 51402	M20 x 1.5P	0.10	25	50	20,50€
	D 51403	M13 x 1.5P	0.15	50	100	17,50€
	E 14930	M13 x 1.5P	0.05	10	100	9,50€
	F 14931	M15 x 1.5P	0.05	50	100	8,00€
	G 14932	M17 x 1.5P	0.07	5	100	9,50€
	H 14933	M20 x 1.5P	0.10	5	100	9,50€

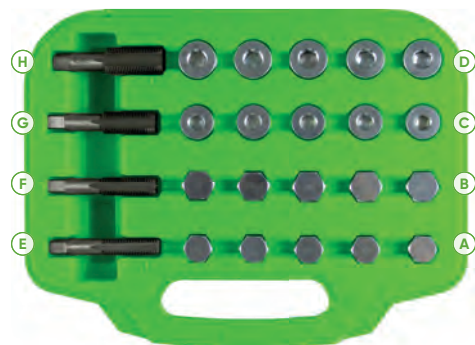

53485

140,00€

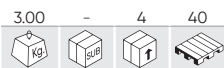

KIT DE ENCHIMENTO DE ÓLEO COM FUNIL E ADAPTADORES



- A Adaptador roscado M42 x 4.5 para Subaru
- B Adaptador roscado M37 x 3.0 (tipo curto) para Lotus, Pontiac, Scion, Toyota
- C Adaptador roscado M35 x 4.0 para Ford, Jaguar, Land Rover, Mazda
- D Adaptador roscado M32 x 3.5 para Acura, Dodge, Ford, Honda, Jaguar, Jeep, Land Rover, Mazda, Nissan
- E Adaptador baioneta para Toyota & Lexus 3.0 & 3.3L V6
- F Adaptador baioneta para Audi, BMW, Mercedes-Benz, Porsche, Volvo, VW
- G Adaptador roscado M30 x 3.0 para Dodge Cummins
- H Adaptador roscado (1/2 volta) para Mazda 3 / 6 / CX-5
- I Adaptador roscado (1/2 volta) para Cadillac, Chevy, Ford, GMC, Hyundai, Jaguar, Land Rover, Mazda, Saab, Mercury
- J Adaptador roscado (1/4 volta) para novas tampas de óleo desde 2008 para Audi, Seat, Skoda, VW com motor EA888
- K Adaptador roscado (1/2 volta) para Dodge Hemi 6.4L (2011-) & >3.6L (>2014)
- L Adaptador roscado M37 x 3.0 (tipo longo) para Lotus, Pontiac, Scion, Toyota

53347

100,00€



KIT DE ENCHIMENTO DE ÓLEO COM FUNIL E ADAPTADORES



- A Adaptador roscado M42 x 4.5 para Subaru
- B Adaptador roscado M37 x 3.0 (tipo curto) para Lotus, Pontiac, Scion, Toyota
- C Adaptador roscado M35 x 4.0 para Ford, Jaguar, Land Rover, Mazda
- D Adaptador roscado M32 x 3.5 para Acura, Dodge, Ford, Honda, Jaguar, Jeep, Land Rover, Mazda, Nissan
- E Adaptador baioneta para Toyota & Lexus 3.0 & 3.3l V6
- F Adaptador baioneta para Audi, BMW, Dodge, Mercedes-Benz, Porsche, Volvo, VW

52305

106,00€



KIT REPARADOR DE VELAS DE AQUECIMENTO

16 PCS



- Extrator de velas de pré-aquecimento de 16 peças.
- Este kit é útil para a extração da vela partida ou presa.
- Universal e ideal para motores Mercedes-Benz CDI.
- Extraí as velas partidas ou presas M8 e M10.
- Inclui machos para rosca 1/4" M8 e broca de alta resistência de duplo tamanho M8 e M10.

51494

107,00€



KIT EXTRAÇÃO DE INJECTORES

9 PCS S



	M12 x 1.75	M8 x 1.5		M14 x 1.5	M8 x 1.5
	M14 x 1.5	M17 x 1.5		M14 x 1.5	
	M14 x 1.5	M27 x 1.0		HRC: Hardness 30 -35	
	M14 x 1.5	M12 x 1.75		1.75Kg.	
	M14 x 1.5	M8 x 1.5			

54186

250,00€



EXTRATOR PNEUMÁTICO PARA INJETORES

6-8 BAR

S

20-30 Nm

BOSCH, DELPHI, DENSO, SIEMENS

REF.	DESCRIÇÃO	kg	sub	un	€
16366	M20X1,0 10MM	0.13	-	30	11,00€
16367	M10X1,5 14MM	0.08	-	30	10,00€
16368	M14X1,5 15MM	0.10	-	30	12,00€
16369	M14X1,5 33MM	0.12	-	30	12,00€
16370	M16X1,5 18MM	0.10	-	-	12,00€
16371	M17X1,0 10MM	0.11	-	30	11,00€
16372	M18X0,75 10MM	0.10	-	30	11,50€
16373	M18X1,5 18MM	0.10	-	30	12,00€
16374	M22X1,5 15MM	0.10	-	30	12,00€
16375	M25X0,5 9MM	0.10	-	30	15,00€
16376	M25X1,0 13MM	0.10	-	30	15,00€
16377	M26X0,75 15MM	0.10	-	30	16,00€
16378	M27X0,75 10MM	0.10	-	30	15,00€
16379	M29X1,0 11MM	0.10	-	30	15,00€
16380	M31X0,75 15MM	0.12	-	30	16,00€

REF.	DESCRIÇÃO	kg	sub	un	€
16381	M8X1,0 14MM	0.09	-	30	10,00€
16382	M8X1,25 14MM	0.01	-	30	10,00€
16383	M14X1,5 9MM	0.13	-	30	15,00€
16384	M14X1,5 9MM	0.11	-	30	15,00€

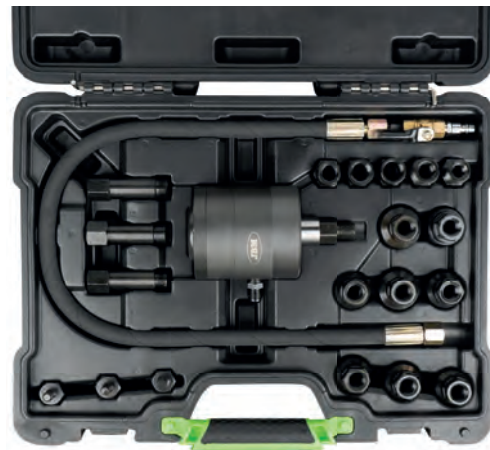

54345

15,00€

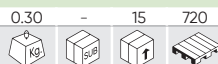

SPRAY DE GELO

-42° 400ml

UFI: MD82-13A7 G004-V27H

Ideal para uso em superfícies metálicas, resfriando o material e favorecendo a contração do aço para facilitar a extração



16295

30,00€



CONJUNTO DE 3 ADAPTADORES PARA EXTRACTOR DE INJECTORES (REF.54186)



52858

298,00€

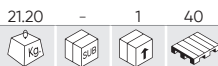

KIT DE EXTRAÇÃO DE INJECTORES

Martelos	1,6Kg (160mm)
	2,7Kg (460mm)
	5,1Kg (600mm)
Puxando a aderência com a abertura da forquilha	13,7x18mm (105mm)
	12,7x19mm (130mm)
Vasos de fenda (6pt)	1/2" - 25, 27, 28, 29, 30mm (100mm)
Adaptador com rosca externa	M27x1.0
	M25x1.0
Adaptador com rosca interna	M27x1.0
	M17x1.0mm
Eixo extrator injetor	Ø 35mm
	Ø 29mm
Adaptador de martelo deslizando para extrator interno, externo e garra	

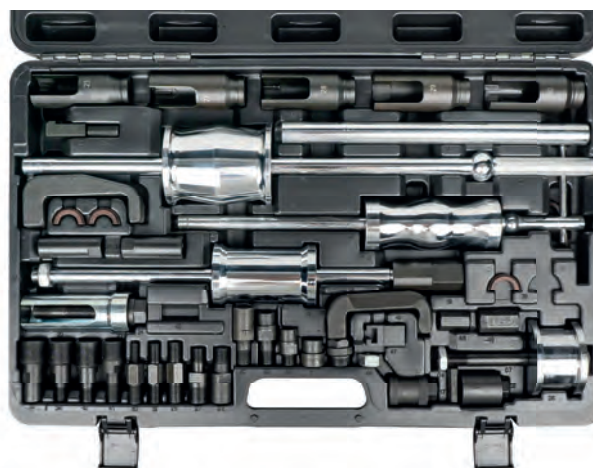

51493

68,00€

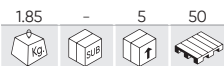

MEDIDOR E COMPROVADOR DE SISTEMA DE INJEÇÃO

31 PCS

BOSCH, SIEMENS, DENSO, DELPHI

A finalidade deste kit é medir com rapidez e eficácia a quantidade de combustível que cada injetor retorna ao depósito, de modo que você saberá se algum injetor está estragado. Adequado para uso em Bosch, Siemens, Denso e Delphi injetor.

CONTÉM

- Suporte para pendurar os 6 frascos para a medição do combustível.
- Tubos de medição
- Tubos brancos
- Caixa de armazenamento



REF. DESCRIÇÃO



12901 POTE + TAMPA + MANGUEIRA PARA REF.51493 0.03 10 60 - 5,20€

54391

221,00€

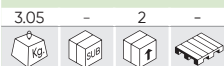

TESTE PARA BICOS INJETORES DE DIESEL

0-60 MPA 5-8 BAR 0-600 BAR 0-8700 PSI M12 M14

Esta ferramenta ajuda-o a verificar o estado dos injetores sob pressão. É especialmente indicado para verificar o padrão de atomização e a pressão de abertura dos injetores.

x1 M12
x2 M14



54392

1.855,00€

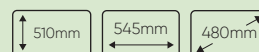
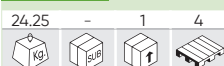

LIMPADOR E TESTADOR DE INJETORES GDI / EFI

220V 60W 50-60 Hz
0,1-10 BAR 5-8 BAR
<85% -10°C 40°C

Este produto permite-lhe limpar e verificar o funcionamento correto dos injetores GDI e EFI. Devido ao seu microcontrolador, a máquina é capaz de simular as condições reais de funcionamento do motor. Desta forma, podem verificar o comportamento de cada injetor e detectar possíveis falhas nos injetores.

Para a limpeza dos injetores, utilize a limpeza por ultra-sons. Ele garante assim a completa eliminação dos resíduos que possam estar presentes nos injetores tanto nos de gasolina como nos de gasóleo. Para os sistemas EFI inclui-se também o modo de limpeza no veículo.



VÍDEO TUTORIAL

54220

197,00€

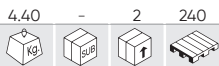

KIT DE FERRAMENTAS PARA INSTALAÇÃO E DESMONTAGEM DE INJETORES DE COMBUSTÍVEL PARA BMW MERCEDES

MARCAS	<p>BMW: 135iS (2008-), 335 (2007-), 335xi (2007-), 535i (2008-), 535xi (2008-), 550i GT (2010-), 750Li (2009-), 750Li (2009-), X3 3.0i (2007-), X5 (2011-), X5 3.0i (2008-), X6 (2008-)</p> <p>MERCEDES-BENZ: C-CLASS (2007-), CLK / SLK (2007-), E-CLASS (2007-), A / CLA / GLA 45 AMG (2013-), CL / CLS 63 AMG (2010-), E / G / GL 63 AMG (2011-), GLE 63 AMG (2015-), S / SL 63 AMG (2010-), SLK 55 AMG (2012-)</p>
FERRAMENTAS OEM	<p>BMW: 130180(1), 130195(2), 130270(3), 130320(4), 2249115(5)</p> <p>MERCEDES-BENZ: 271589023300(6), 278589003300(7)</p>
CÓDIGOS DE MOTOR	<p>BMW: N14 / N18 / N20 / N47 / N54 / N57 / N55 / N63</p> <p>MERCEDES-BENZ: M133 / M152 / M157 / M270 / M271 / M274 / M276 / M278</p>

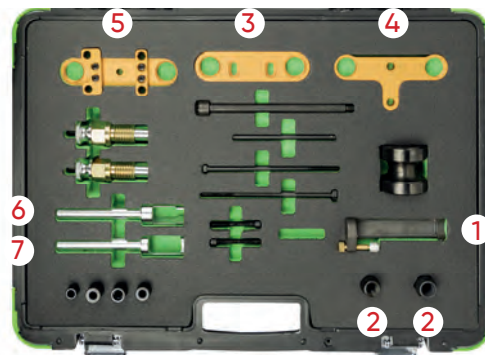

52815

110,00€



KIT EXTRATOR DE VELAS INCANDESCENTES

22 PCS



53250

85,00€



KIT DE EXTRATORES DE ROLAMENTOS INTERNOS E EXTERNOS

5 PCS



53069

98,00€



KIT DE EXTRAÇÃO DE INJETORES DIESEL PARA CITROËN, PEUGEOT

9 PCS

CITROËN, PEUGEOT



- x1
- x3
- x2 Ø 17mm
- x2 Ø 25mm
- x2 25mm
- x2 29mm
- x1 21mm

52629

99,00€



KIT DE EXTRAÇÃO PARA INJETORES MERCEDES

3 PCS

MERCEDES



M16x1.5

52639

123,00€



KIT PARA BRAZOS DIREÇÃO

- Ø 30-35mm
- Ø 35-40mm
- Ø 40-45mm



53464

153,00€



SORTIMENTO DE ANILHAS DE COBRE PARA INJETORES 551 PCS

551 PCS

PARA MAIS INFORMAÇÕES

PÁGINA 387



53501

24,00€

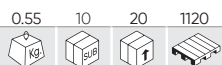

EXTRATOR DE BOMBA DE INJEÇÃO DIESEL BMW



OEM 1 13 5 191 | 13 5 192 | 13 5 190 BMW.
BWM: M47 / M47T2 / M47TU / M57 / M57TU.
SERIES: E46 (318D-320D) (1988 - 2005) and E60, E61 (318TD-320TD-525D-530D-530-535) (2000 - 2006).

53009

42,00€

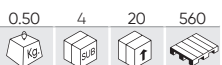

EXTRATOR DE TUBO DE INJEÇÃO DIESEL



3 PCS 1/2" 14, 17, 19mm

53522

24,00€



EXTRATOR DE ANILHAS DE INJETORES



350mm Ø 4,5-15mm

53696

22,00€



EXTRATOR DE ABRAÇADEIRAS HENN



VOLKSWAGEN, AUDI, SEAT, ŠKODA, BMW, PEUGEOT, CITROËN, DACIA, FIAT, FORD, KIA, LEXUS, MAZDA, MERCEDES, NISSAN, OPEL/VAUXHALL, PORSCHE, RENAULT, TOYOTA, VOLVO.

52757

16,00€

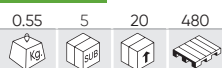

EXTRATOR UNIVERSAL DE AFORADORES



53490

275,00€



COMPROVADOR DE PRESSÃO PARA DIESEL E GASOLINA

- M24
- M20
- M24
- M20
- Ø 10, 12, 14, 18mm



53096

28,80€



CHAVE PARA TAMPA DE AFORADORES

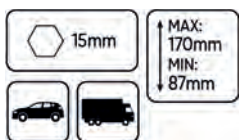

ALFA ROMEO, BMW, CHRYSLER, CITROËN, DAEWOO, FIAT, FORD, HONDA, HYUNDAI, ISUZU, JEEP, KIA, LADA, LANCIA, LAND ROVER, LDV, MAZDA, MERCEDES, MG, MITSUBISHI, NISSAN, PEUGEOT, RENAULT, ROVER, SAAB, SSANGYONG, SUZUKI, TOYOTA, VAG, VAUXHALL/OPEL, VOLVO

54373

395,00€



MANÓMETRO COMMON RAIL DE ALTA PRESSÃO



x2	M12x1,25	x6	M12x1,50
x2	M14x1,25	x6	M14x1,50

Uma ferramenta essencial para medir a pressão elevada gerada pelo curso de compressão num cilindro de ar de um motor a diesel. Tem uma variedade de adaptadores para ligações e especificações diferentes que podem medir tipos diferentes de motores a diesel



N

54312

191,50€



KIT DE TESTE DE COMPRESSÃO - DIESEL



DIÂMETRO INTERNO
10, 12, 14, 18mm
DIÂMETRO EXTERNO
M20, M22, M24

ALFA, BMW, FIAT, FORD, LDV, PSA, RENAULT, SUZUKI, SAAB, CHRYSLER, DAEWOO, HYUNDAI, MERCEDES, MITSUBISHI, NISSAN, LANDROVER, MAZDA, ISUZU, OPEL.



52599

230,00€



COMPRESSÍMETRO PARA SISTEMA DE CIRCUITO DE COMBUSTIVEL

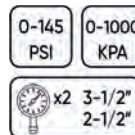

52489

58,00€



MEDIDOR DE COMPRESSÃO DIESEL

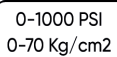

M18x1.5mm
M24x1.5mm
M24x2.0mm
M10x1.0x68mm
M10x1.25x45mm
M10x1.25x54mm
M10x1.25x68mm

FORD, BMW, MERCEDES BENZ, VW, CITROËN, MITSUBISHI, TOYOTA, PEUGEOT, RENAULT, VOLVO, MAZDA.

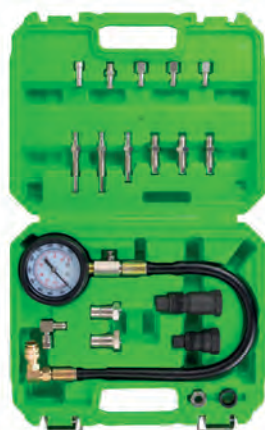

52685

88,00€



MEDIDOR DE COMPRESSÃO DIESEL PARA CAMIÃO



M18
M24



53997

48,00€

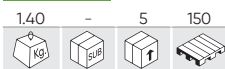

KIT DE TEST DE PRESSÃO - GASOLINA

0-10 BAR 0-140 BAR

COMPRIMENTO	25,5cm (1), 29,5cm (2), 110cm (3)
DIÂMETRO EXTERNO	1,2cm (1), 1,2cm (2)
DIÂMETRO INTERNO	0,6cm (1), 0,6cm (2)



54016

76,00€



BOMBA DE COMPROVAÇÃO DE PRESSÃO

PRESSÃO MÁXIMA

40 PSI (3 BAR)

PRESSÃO MÍNIMA

-20 PSI (-0,75 BAR)



52488

28,00€

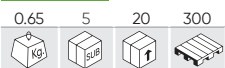

MEDIDOR DE COMPRESSÃO GASOLINA

0-300 BAR 0-21 Kg/cm2



53489

68,00€

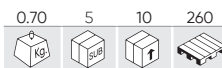

COMPROVADOR DE PRESSÃO DO TURBO

-1~3 BAR 2m



52076

111,00€



KIT PARA REPARAR ROSCAS DE VELAS DIESEL

- 1 Ferramenta instalação de casquilho - 2uds.
- 2 Pega para varilha - 1ud.
- 3 Casquilhos M8 x 1.0 - 5uds.
- 4 Casquilhos M10 x 1.0 - 5uds.
- 5 Casquilhos M10 x 1.25 - 5uds.
- 6 Casquilhos M12 x 1.25 - 5uds.
- 7 Bujão c/ extremidades s/rosca - 3uds.
- 8 Barra de instalação de casquilhos - 1ud.
- A Macho de roscar M14 x 1.25 (para casquilhos de M12 x 1.25) - 1ud.
- B Macho para abrir roscas M12 x 1.25 - 1ud.
- C Macho de roscar M12 x 1.0 (para casquilhos de M10 x 1.25) - 1ud.
- D Macho de abrir rosca M10 x 1.25 - 1ud.
- E Inserción de corte M10 x 1.0 (para roscas de M8 x 1.0) - 1ud.
- F Inserción de corte M8 x 1.0 - 1ud.



REF.	Icon	€
11893	M8x1.0 0.01 5	7,00€
11894	M10x1.0 0.01 5	7,00€
11895	M10x1.25 0.02 5	8,65€
11896	M12x1.25 0.02 5	8,80€

FERRAMENTA ESPECIAL

52813

79,00€



KIT DE CHAVES DE INJETORES 17 PCS

17 PCS



	x8	14x14, 15x19, 15.5x15.5, 17x17x, 17x17.5, 17x19, 17x19.5, 17x20mm
	x4	15.5x15.5, 17x17, 17.5x20.5, 17x21mm
	x1	19x21.5mm

	x1	19x225mm
	x1	19x170mm
	x1	19mm
	x1	2.5mm

52273

44,00€



KIT DE CHAVES DE INJETORES

8 PCS

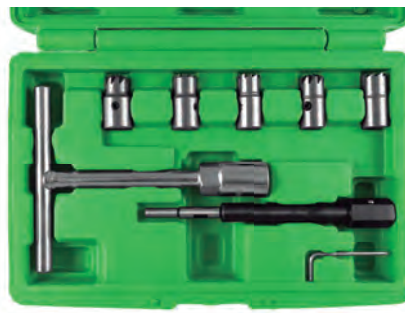

	x3	15x19mm 17x17mm BMW, PSA, Renault, Ford 17x19mm Mercedes CRD
	x2	17x17mm Mercedes 17x21mm Fiat/Iveco

	x1	12mm
	x1	19mm
	x1	

53650

47,00€

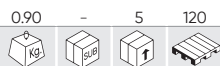

KIT LIMPADOR DE INJETORES DE VEDAÇÃO

19 PCS

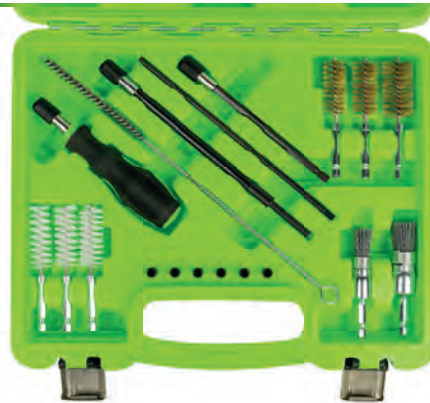

REF.	DESCRIÇÃO					€
14348	CONJUNTO DE 3 ESCOVAS DE LIMPEZA DE LATÃO (REF.53650)	0.05	-	50	-	12,50€
14349	CONJUNTO DE 2 ESCOVAS DE LIMPEZA DE SILICONE (REF.53650)	0.07	-	100	-	20,50€

53330

38,00€

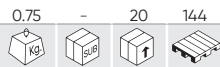

SET DE CHAVES PARA BOMBA INJETORA

5 PCS 1/2" 1/4" Cr-V



52801

26,00€

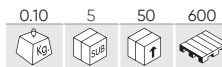

BOMBA INJETORA DIESEL



52821

28,80€

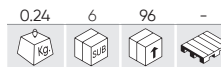

CHAVE DUPLA ABERTA PARA INJECTORES

17mm



PUNÇÕES

Permitem a aplicação de marcação digital ou alfabética em qualquer superfície de metal por método de indentação ou impacto. A área de trabalho arredondada evita rachaduras ou fraturas na superfície tratada.

52422 24,70€

0.82 3 6 540

A-Z & 0-9

36 PCS 3/16"

5mm

53119 52,00€

1.94 3 6 504

A-Z & 0-9

36 PCS 5/16"

8mm

52882 14,00€

0.30 10 60 1500

9 PCS 1/4"

6mm 0-8

51120 41,00€

2.10 - 5 120

GRAMPO DE VÁLVULAS

- Apto para carros e motos.
- Os 5 adaptadores permitem um encaixe correcto e fácil para comprimir a mola da válvula.
- Compressor de Molas.
- Adaptador de: 30, 25, 23, 19, 16mm.

52734 51,00€

2.61 - 5 175

COMPRESSOR DE MOLA DE VÁLVULAS 45-145MM

Ø 30mm Ø 25mm

45-145mm

52693 24,50€

0.65 5 20 450

COMPRESSOR DE MOLA PARA VÁLVULAS

53251 88,00€

2.80 - 4 60

KIT DE FERRAMENTAS PARA AROS DE PISTÃO

H:3" Ø 53-125mm

H:4" Ø 60-175mm

H:6" Ø 60-175mm

52697 16,00€

0.50 5 40 720

COMPRESSOR AROS PISTÃO 6"

6"

Ø 60-175mm

150mm

52696 12,00€

0.28 5 40 1200

COMPRESSOR AROS PISTÃO 3"

3"

Ø 53-175mm

77mm

FERRAMENTA ESPECIAL

ALICATES PARA ANÉIS DE PISTÃO

REF.	DESCRIÇÃO					€
54273	40-100mm	0.30	6	30	-	10,10€
54274	80-120mm	0.35	6	30	-	11,00€
54275	100-160mm	0.40	6	30	-	13,20€



52591	12,00€	52592	22,00€	52593	34,00€
0.10 12 72 1728		0.20 - 20 480		0.47 6 36 648	
POLIDORA DE CILINDROS - 2 BRAÇOS 1 - 1/8"		POLIDORA DE CILINDROS - 3 BRAÇOS 2"		POLIDORA DE CILINDROS - 3 BRAÇOS 4"	

1-1/8"
28,60mm
MAX: Ø 55mm
MIN: Ø 19mm



2"
50,80mm
MAX: Ø 85mm
MIN: Ø 35mm



4"
101,60mm
MAX: Ø 170mm
MIN: Ø 55mm



REF.	DESCRIÇÃO					€
11878	CONJUNTO DE 2 PASTILHAS DE POLIMENTO 1-1/8" PARA REF. 52591	0.10	25	100	-	4,10€
11879	CONJUNTO DE 3 PASTILHAS DE POLIMENTO 2" PARA REF. 52592	0.04	25	100	-	5,10€
11880	CONJUNTO DE 3 PASTILHAS DE POLIMENTO 4" PARA REF. 52593	0.09	25	100	-	10,50€

53662	89,00€
1.78 5 10 80	
COMPROVADOR DE FUGA PARA JUNTAS DE CILINDROS	

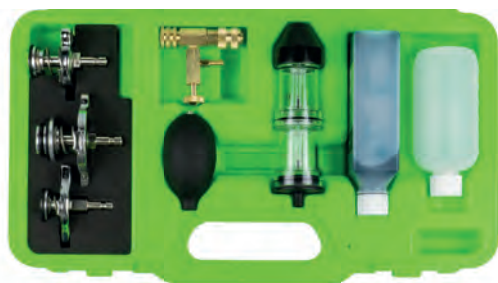

CONTÉM
Garrafa redonda de 200ml.
Garrafa quadrada de 250 ml.
ADAPTADORES
Pequeno: Suzuki, Toyota, Mitsubishi.
Médio: Suzuki, Toyota, Mitsubishi, Subaru, Peugeot, Nissan, Lexus, Mazda
Grande: Ford, GM, Benz, JEEP.

REF.	DESCRIÇÃO					€
14563	FLUIDO DE TESTE DE FUGAS DE COMBUSTÃO	0.23	5	50	-	18,00€

54347	46,00€
2.00 - 5 100	
VERIFICADOR DE FUGAS DE CILINDROS	



7 BAR **100 PSI**

É utilizado para verificar as vazamentos de um cilindro.

M12x1.25
M14x1.2

52832

75,00€

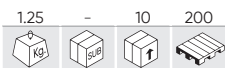

JOGO DE CHAVES CURVADAS PARA EXTRAÇÃO DE CORREIAS 12 CANTOS CABEÇA INTERCAMBIÁVEL



CABEÇA INTERCAMBIÁVEL

x8		12, 13, 14, 15, 16, 17, 18, 19mm	x1	
x1				

52690

54,00€

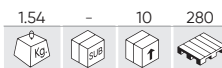

ALAVANCA PARA AFROUXAR CORREIAS

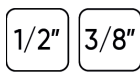

x4		3/8" - 13, 15, 16, 18mm	x1		1/2" - 230mm
x3		3/8" - 13, 14, 15mm	x1		3/8" - 585mm

53669

45,00€

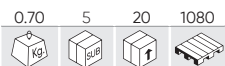

JOGO DE CHAVES DE CAIXA ESPECIAL PARA AUTOMÓVEL DE 10 PCS



- 10S** para engrenagem intermediária Toyota
- 6S** para embreagens, cabeça do bloco de cilindros e eixo de equilíbrio Nissan e Renault
- 8S** para embreagens, cabeça do bloco de cilindros e eixo de equilíbrio Nissan e Renault
- 12S** para embreagens, cabeça do bloco de cilindros e eixo de equilíbrio Nissan e Renault
- 8TS** para eixo balanceador Nissan
- 14mm** para pinças de freio Opel Astra G, Opel Zafira e Smart
- 10mm** para sistema de freio e bomba de combustível Nissan
- 12,5mm** para sistema de freio e bomba de combustível Nissan
- 19mm** para pinças de freio Peugeot, Renault e Citroen
- 20mm** para braço de controle inferior Honda Civic

53053

12,00€

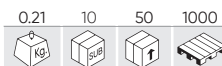

GANCHOS PARA EXTRAIR JUNTAS

1x15,5cm/1x16,5cm/1x12cm



53637

85,00€

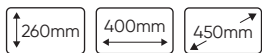

ORGANIZADOR PARA COMPONENTES DO MOTOR ESPECIAL PARA PEÇAS DE CABEÇOTES

- Especial para peças de cabeçotes.
- Mantém todos os componentes limpos e arrumados à medida que são removidos da cabeça do cilindro.
- Economize tempo. Isso facilita o seu trabalho.



52850

7,80€



2PCS FERRAMENTA PARA RODAR VÁLVULAS



FERRAMENTA ESPECIAL

51989

49,00€

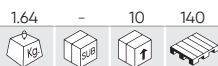

KIT 38 ESCOVAS DE LIMPEZA METAL / PLÁSTICO

38 PCS

Ø 8, 9, 10, 11, 12, 13, 14, 15, 16, 17, 18, 19mm



- 1 Cabo de 1/4".
- 1 Alargador.
- 36 escovas.

52760

4,10€

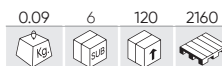

CEPILLO METÁLICO



52515

9,10€



KIT DE 3 ESCOVAS METÁLICAS

- 1 x Latão.
- 1 x Nylon.
- 1 x Aço.



52819

22,00€

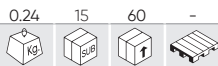

CHAVE 1/2" PARA CAMARA COMBUSTIÓN (MERCEDES)

58 DENTES



53129

84,00€

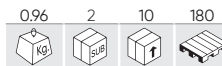

INSTALADOR AJUSTÁVEL DE RETENS 18-90MM



53875

134,00€



EXTRATOR/INSTALADOR DE CAMBOTA (GRUPO VAG)

MARCAS	VW: GOLF, TOURAN AUDI: A3, A4
FERRAMENTAS OEM	T10134
CÓDIGOS DE MOTOR	1.4I TURBO 1.4 E 1.6 INJEÇÃO DIRETA DE COMBUSTÍVEL 1.9 / 2.0 SDI 2.0 MOTORES DIESEL COMMON RAIL



52190

8,00€

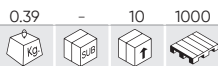

CHAVE DE EMBREAGEM ESPECIAL FIAT

220x110mm



52495

14,50€

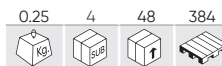

CENTRALIZADOR EMBREAGENS UNIVERSAL (PLÁSTICO)

- Centralizador de embreagem útil para a maioria dos modelos do mercado.
- Inclui 3 adaptadores de diferentes diâmetros.



53001

242,00€

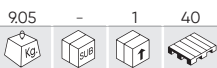

KIT CENTRADOR DE EMBREAGEM SAC

VW, AUDI, BMV, MERCEDES, VOLVO, RENAULT, OPEL

- A ferramenta especial de pré-carga da embreagem, impede que o anel de aperto rode no prato de pressão da embreagem.
 - A não utilização da ferramenta especial pode provocar danos no prato de pressão da embreagem e provocar um falho do conjunto da embreagem.
 - Adequado para quase todas as embreagens SAC (auto-ajustáveis).

VANTAGENS
 Tensado da placa de pressão do embreagem em o montagem e desmontagem.
 Reposição mola de ajuste com a ferramenta de reinicialização.
 Centralização da válvula com respeito ao rolamento guia.

CONTÉM
 Tensor de Embreagem.
 Centralizador de 3 braços.
 Ferramenta para repor parâmetros de origem.
 Jogo de pinos centralizadores.
 Centralizador de 4 braços.



53410

92,00€

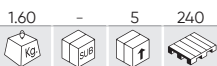

CENTRALIZADOR DE EMBREAGEM SAC

DIÂMETRO CENTRADORES

x3 15-19, 20-26,6, 23-36mm

DIÂMETRO ACCESORIOS

x8 12, 14, 15, 16, 17, 18, 19, 20mm

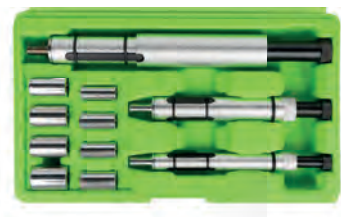

53057

149,00€

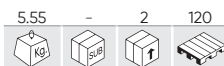

KIT DE REPARAÇÃO DO EMBREAGEM DUPLA FACE PARA LA TRANSMISSÃO DSG DE VAG

- Para serviço em cambios DSG em Golf (2004-), Golf Plus (2005-), AUDI A3 (2004-) com transmissão de 7 velocidades código OAM, e em Touareg (2003-) com transmissão de 6 velocidades código 08D).
 - Referencias OEM dos úteis T10323, T10373, T10374.



50731

68,00€

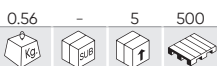

REFRATÔMETRO PARA ÁLCOOL



52963

49,00€

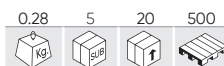

REFRATÔMETRO UNIVERSAL

- Etileno glicol: -50°C ~ -0°C.
 - Propileno glicol: -50°C ~ -0°C.
 - Fluido de limpeza: -40°C ~ -0°C.
 - UREA AUS32: - 30% ~ 35%.
 - Fluido de bateria: - 1.100 - 1.400 sg/l.



UREA AUS32

53477

36,10€

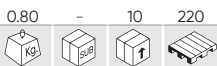

KIT DE 8 PINÇAS PARA A DESCONEXÃO DE MANGUEIRAS

8 PCS

NYLON

8mm
 10mm
 13mm



53426

39,80€

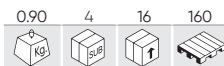

PROVADOR DE PRESSÃO E VÁCUO

PRESIÓN 0-0,7Kg/cm² (0-10 PSIG)
 PRESSURE
 VACÍO 0-28 inHg (0-70 cmHg)
 VACUUM



FERRAMENTA ESPECIAL

52066

12,00€

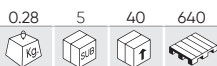

KIT DE ALICATES PARA MANGUEIRAS FLEXIVEIS



0-20mm
0-35mm
0-70mm

53395

16,00€

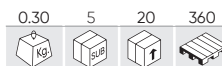

KIT DE ALICATES PARA MANGUEIRAS FLEXIVEIS



Ø13mm
Ø20mm
Ø35mm

52687

168,00€



COMPROVADOR DE VAZAMENTO DE PRESSÃO PARA SISTEMA DE REFRIGERAÇÃO

- 1 Bomba de pressão com válvula de descarga
- 2A Conector 1: acoplador para os cabeçães No.3(R123) e No.4 (R124)
- 2B Conector 2: acoplador para os cabeçães No. 3(R123) y No. 5(R125)
- 3 Mercedes (W123, W126, W124, W201), GM(Buick), Jeep
- 4 Peugeot, Subaru, Chrysler, Acura, GM (Nova, Spectrum, Sprint), Mitsubishi, Nissan, Mazda, Toyota, Infiniti, GEO, Suzuki, Isuzu, Mercedes
- 5 Honda, Toyota, Suzuki, Mitsubishi, Chrysler, Acura
- 6 Mercedes Benz (ML, W163, W164), GM (Achiva, Skylark, Grand Am 1992~2002)
- 7 Volvo, Saab, Sterling, Citroën, Renault, Fiat, Alfa, Jeep
- 8 VW(Vento, T4, Passat-1996, Golf, Beetle, Sharan)
- 9 Audi(A4, A5, A6), BMW 345, VW (Passat - 1997-2002), Porsche(Cayenne)
- 10 BMW (E46, E36, E34, E39, E38, E32, E90)
- 11 Audi, VW
- 12 Internacional, Land Rover, Jaguar
- 13 Mercedes (C, E, S, W140, W220, W124, W210, W211, W215, W216, W221, R230)
- 14 Ford Focus
- 15 Mazda(M3)
- 16 Mercedes classe A (W168)
- 17 BMW E60, E63, E64, E65
- 18 VW SHARAN 1.8T 2.8
- 19 TOYOTA-RAV4, PREVIA Adaptador universal de goma para purga e enchimento adores



- 20 SAAB
- 21 LAND ROVER
- 22 Kia
- 23 Hunday

54139

147,00€



KIT UNIVERSAL DE TESTE DE PRESSÃO DO SISTEMA DE REFRIGERAÇÃO (5 PÇS)



x1 17-24mm
x1 28-31.5mm
x1 37-39.5mm
x1 47-48.5mm



53453

7,00€

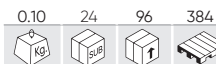

COMPROVADOR DE ANTICONGELANTE

-43°C
131°C



54368

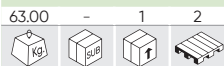

2.329,00€

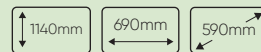

MÁQUINA DE LIMPEZA DO SISTEMA DE REFRIGERAÇÃO

Esta máquina permite-lhe limpar e abastecer todo o sistema de arrefecimento do veículo de forma rápida e eficiente. Ao gerar pressão, faz circular o líquido de refrigeração por todo o sistema e limpa-o de sistema de várias impurezas. É compatível com diferentes tipos de líquidos de refrigeração.

A máquina está ligada à bateria do veículo a 12V e possui uma interface intuitiva que, juntamente com o ecrã tátil, dois manómetros e dois visores para monitorizar o estado do fluido, tornam-na muito fácil de utilizar. Estão disponíveis conectores rápidos, tubos e adaptadores para facilitar a sua utilização convenientemente na maioria dos veículos. Contém dois depósitos de 20 litros, um para o líquido de refrigeração novo e outro para o usado.

Os dois depósitos são esvaziados através da própria máquina. Nos circuitos com presença de ferrugem ou óleo, recomenda-se a utilização de aditivos para um maior poder de limpeza.



53539



66,00€

KIT DETECÇÃO FUGA AA/CC

CONTÉM

- 1 x lâmpada UV 100Lm.
- 1 x óculos de visão UV.
- 1 x seringa inserção líquido.
- 1 x adaptador rápido.
- 1 x adaptador de extensão.
- 1 x pila recargável.
- 1 x carregador.



REF. DESCRIÇÃO

REF.	DESCRIÇÃO	Q1	Q2	Q3	€
15052	BATERIA RECARREGÁVEL PARA NO. 53539	0.05	5	10	3,00€
15053	CARREGADOR DE BATERIA PARA NO. 53539	0.08	-	10	10,50€
15054	LÂMPADA PARA NO. 53539	0.12	-	50	34,00€
14187	ÓCULOS UV (REF.53539)	0.05	10	120	6,00€
12200	SERINGA DETECÇÃO DE VAZAMENTO AA/CC REF. 52844	1.10	-	50	14,50€

54291

5.054,00€

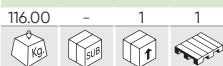

ESTAÇÃO DE CARGA PARA AR CONDICIONADO

200V ±10%	R134A R1234YF
3/8 HP	>2 Kg/min
450g/min	100 L/min
LCD 360x128mm	12,12 cm ³
50-60 Hz	-10° 50°
99%	180W

Esta máquina foi projetada para realizar trabalhos de limpeza, recuperação de refrigeração, vácuo, injeção de óleo e recarga de gás no sistema de ar condicionado do veículo. É totalmente automático. Uma vez configurados os parâmetros de cada função, a máquina realizará todos os processos sem a necessidade do operador estar sempre atento.

AS PRINCIPAIS CARACTERÍSTICAS DO PRODUTO SÃO:

- FÁCIL DE USAR
- COM GRANDE JANELA DE INSPEÇÃO E RETROILUMINAÇÃO LED
- OS MANÔMETROS FACILITAM A OBSERVAÇÃO DOS VALORES DE PRESSÃO
- ALTA TAXA DE RECUPERAÇÃO DE GÁS E ÓLEO.
- COM GRANDE DISPLAY LCD
- COM BANCO DE DADOS E IMPRESSORA
- O SOFTWARE E O BANCO DE DADOS PODEM SER ATUALIZADOS



REPOSIÇÕES DISPONÍVEIS



VÍDEO TUTORIAL

N

16309

149,00€

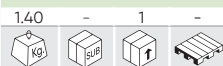

KIT DE 2 TUBOS DE ALTA E BAIXA PRESSÃO COM 5 METROS DE COMPRIMENTO (REF.54291)



N

ADAPTADOR PARA CARGA DE GÁS 1234YF

Adaptador de ar condicionado / refrigerante de conexão rápida R1234YF. Vermelho (alta pressão). O desenho de conexão rápida permite segurança completa. Com conexão que protege contra ferimentos e perda de refrigerante se desconectada sob pressão. Uso: AACC e refrigerante



53499

29,00€



ADAPTADOR PARA CARGA DE GÁS 1234YF (ALTA)

- Vermelho (alta pressão)
- Material: latão e metal
- Peso: 194g



53500

29,00€



ADAPTADOR PARA CARGA DE GÁS 1234YF (BAIXA)

- Azul (baixa pressão)
- Material: latão e metal
- Peso: 175g



53456

98,00€

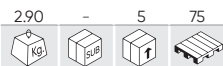

KIT DE COMPROVAÇÃO, ENCHIMENTO E ESVAZIAMENTO DE SISTEMA AACC (BAR)

BAR	LOW: 0-24BAR HIGH: 0-34BAR
PSI	LOW: 0-350PSI HIGH: 0-500PSI



REF.	DESCRIÇÃO	kg	un	un	un	€
14300	ACOPLADOR DE REMOÇÃO RÁPIDA DE ALTA PRESSÃO (REF. 53456)	0.15	-	100	-	19,00€
14301	ACOPLADOR DE REMOÇÃO RÁPIDA DE BAIXA PRESSÃO (REF. 53456)	0.15	-	100	-	19,00€

16316 18,50€

0.30 - 12 -

ÓLEO UNIVERSAL PAG PARA AR CONDICIONADO 250ML

N

12977 36,50€

0.33 3 12 480

LÍQUIDO DETECÇÃO FUGA SISTEMA AACC 250 ML

- Uma aplicação de 7,5 ml para 1.4L de refrigerante.

50807 38,00€

0.16 6 24 744

KIT DE O'RINGS PARA AACC

Diâmetro	PCS	Diâmetro	PCS
5.29x1.78	20	8.80x1.90	20
6.07x1.78	20	10.82x1.78	15
6.8x1.9	20	10.77x2.62	15
7.65x1.78	20	11.0x2.0	15
7.80x1.90	20	12.0x2.0	15
8.0x2.0	20	13.9x1.80	10

Diâmetro	PCS
13.95x2.62	10
14.0x2.0	10
15.0x2.0	10
17.0x2.0	10
17.17x1.78	10
17.04x3.53	10

53599 30,30€

0,16 10 100 -

KIT DE VÁLVULAS PARA O AR CONDICIONADO

REPOSIÇÕES DISPONÍVEI

REF	mm	PCS	€
14594	5x19mm R12	50	2,00€
14595	5x19mm	30	1,50€
14596	5x19mm R12	30	2,00€
14597	6x19mm	3	7,60€
14598	6x26mm	1	17,80€
14599	7x20mm R134A	10	4,50€
14600	6x22mm	5	9,50€
14601	8x22mm	1	11,00€
14602	9x22mm	4	11,00€

53459 66,00€

1.05 - 10 150

KIT PARA A DESCONEXÃO DO AR CONDICIONADO

DIÂMETRO DAS BRAÇADEIRAS

x6 8mm (5/16"), 9.5mm (3/8"), 13mm (1/2"), 16mm (5/8"), 19mm (3/4"), 22mm (7/8")

DIÂMETRO DO BLOQUEADOR

x4 9.5 mm (3/8"), 16mm (5/8"), 13mm (1/2"), 19mm (3/4")

54069 29,50€

0.20 10 40 360

KIT DE FERRAMENTAS DE LIMPEZA DE BUCHAS, 14 PÇS

- x1 Bico 8 mm com adaptador 1/2"
- x1 Rebolo de eixo redondo e cabeça hexagonal de 8 mm
- x2 Almofadas removíveis com base autoadesiva
- x5 Rebolos de grão grosso, diâmetro externo de 40 mm
- x5 Rebolos de grão fino, diâmetro externo de 40 mm, diâmetro interno de 14 mm

51364 26,00€

2.00 - 5 315

EXTRATOR DE JUNTAS HOMOCINÉTICAS

Ø 31mm 140-240mm

53638

243,00€

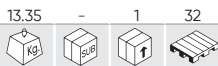

EXTRATOR HIDRÁULICO DE BUCHAS DA RODA

- Este kit inclui 3 extratores / martelos especialmente projectados para simplificar a remoção do cubo da roda e liberar o eixo do cubo sem danificá-lo:
- Eixo hidráulico
- Parafuso
- Martelo de impacto
- Para extracção manual ou hidráulica.
- Com uma capacidade máxima de 10 TON.
- Martelo de 4 kg.
- Comprimento da barra: 57cm.
- Para 3, 4, 5 e 6 furos.



REF. DESCRIÇÃO



15253 FUSO HIDRÁULICO PARA NO. 53384/53638

1.35 1 10 62,00€

54384

32,50€



LIMPADOR DE CUBOS DE RODA

Ajuda-o a remover o óxido e a corrosão presentes no cubo da roda. Inclui uma tira de velcro para instalar facilmente o disco abrasivo.

Diâmetro externo: 150 mm
Diâmetro interno: 90 mm
Velocidade máxima: 500 RPM



N

REF. DESCRIÇÃO



16448 DISCO DE LIMPEZA DE CUBOS DE RODA (REF. 54384) 0.11 16 64 16,50€

52829

19,00€



FERRAMENTA P/MONTAR FOLES DE TRANSMISSÕES

EXTERIOR

Ø 10cm

INTERIOR

Ø 9,5cm

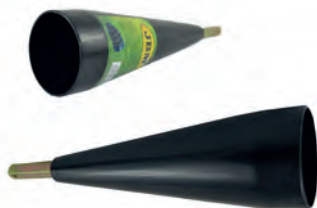

52541

45,00€



COMPROVADOR DE EIXOS



- Jogo para detectar deficiências: em rolamentos, sinoblocos silenciosos, rolamentos de rodas, articulações axiais, rolamentos, estabilizadores, etc.



51121

27,30€



KIT DE COMPRESSOR DE MOLAS

- Garras e pernos reforçados com aleação de ferro - carbono (termo-tratados).
- Indicada para usar em espaços limitados e baixo o arco da roda.
- Abertura máxima: 250mm.



270mm

50827

387,00€

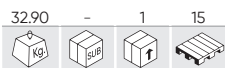

COMPRESSOR DE MOLAS PARA AMORTECEDORES



- Capacidade: 1T (2200 lbs)
- Diâmetro da mola comprimida: 200mm
- Comprimento de compressão: 200-500mm

53742

1.325,00€

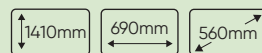

COMPRESSOR MOLAS PARA AMORTECEDORES 1T



- Capacidade de carga: 1000 kg
- Máx. comprimento de trabalho: 450 mm
- Curso do cilindro: 420 mm
- Diâmetro da mola: Ø102-165mm
- Direção do enrolamento: sentido horário
- Princípio de funcionamento: pneumático
- Pressão do ar: 6,5-9 bar (94,27-130,53 psi / 0,65-0,9 MPa)
- Modo de operação: pedal de pé

53394

598,00€

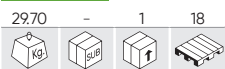

KIT DE COMPRESSÃO DE MOLAS

- Braço telescópico e superfícies antiderrapantes que permitem um aperto sólido das molas.
- Garras equipadas com uma proteção de plástico intercambiável para evitar danificar a pintura da mola.
- Impede que as molas se dobrem na compressão.
- Universal, cobre 90% da frota de veículos.
- Pode ser usado tanto para molas retas como cônicas.

CONTÉM

Dispositivo / pistão.
Três pares de grampos com tampas de plástico.



ADEQUADO PARA USO COM FERRAMENTAS PNEUMÁTICAS

52227

247,00€



KIT COMPRESSOR DE MOLAS MCPHERSON

- Especificações
- Carga máxima: 2500N.
- Um corpo principal.
- Um suporte extendido.
- 3 pares de mandíbulas.
- Par 1: Alcance de uso: 80-115mm. Peso: 1.45kg.
- Par 2: Alcance de uso: 110-195mm. Peso: 2.2kg.
- Par 3: Alcance de uso: 140-195mm. Peso: 2.3kg.

BMW, TOYOTA, FORD, MITSUBISHI, VW, AUDI, SAAB, NISSAN, HONDA ACCORD, SUBARU, VOLVO, OPEL, PORSCHE.



NÃO USAR COM PISTOLA NEUMÁTICA

FERRAMENTA ESPECIAL

52270

109,00€

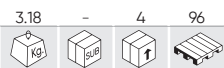

EXTRATOR DE CASQUILHOS PARA VAG

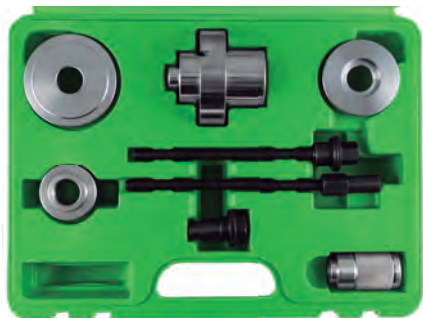

Eixo, extensão de eixo, porca de aperto de M10 x 1,25

Cabeça adaptadora de aço carbônico

Separador

Peça de pressão

Mandril centrado em aleação de alumínio

52432

35,00€



EXTRATOR DE CASQUILHOS FRONTAIS PARA VAG

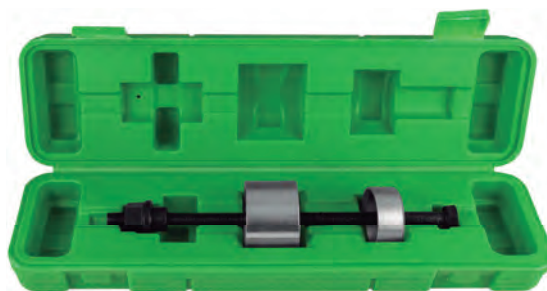

- Útil para VW POLO modelo 2002.

- Facilita a troca dos casquilhos de borracha do eixo frontal.

EXTRATOR

REF.	DESCRIÇÃO	MAX	MIN					€
51368	CHAVE UNIVERSAL DE BARRA DE DIREÇÃO INTERNA	42mm	33mm	0.41	5	50	2700	19,00€
51369	EXTRATOR DE PORCAS FÊMEAS AXIAIS	42mm	35mm	0.55	6	36	756	28,00€
51414	EXTRATOR DE PERNOS	20mm	15mm	0.59	5	40	1440	14,00€



51368



51369



51414

52834

195,00€



CAIXA COM CHAVES COM DENTES EXTERIORES

11 PCS 1/2" Cr-Mo

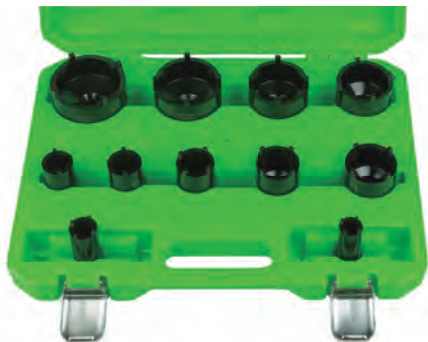

x11 22x3.3mm, 26x3.8mm, 30x4.3mm, 33x4.0mm, 37x4.8mm, 44x5.3mm, 50x5.8mm, 56x5.8mm, 63x6.3mm, 69x6.8mm, 75x6.8mm

52835

272,00€



KIT CHAVES COM DENTES INTERIORES

10 PCS 1/2"



x10 26x5.3mm, 1,2x6.25mm, 34.2x6.3mm, 38.2x6.65mm, 42.2x7.3mm, 50.1x8.25mm, 58.2x9.8mm, 74.6x11.9mm, 82.2x13.25mm, 87.7x13mm

EXTRATOR PARA BRAÇO DE DIREÇÃO

REF.	DESCRIÇÃO					€
52640	Ø 28-35mm	1.80	-	4	256	52,00€
52641	Ø 35-45mm	2.20	-	4	140	55,00€



EXTRATOR PARA BRAÇO DE DIREÇÃO

REF.	DESCRIÇÃO					€
52874	Ø 9-20mm	1.20	4	20	1500	82,00€
52875	Ø 14-23mm	1.25	5	20	1500	79,00€



53635

6.50	-	2	80

85,00€

440-630mm

EXTRATOR DE ROLAMENTOS COM PLACA DESLIZANTE

- Maça deslizante: 4 Kg.
- Faixa de diâmetro: 100-115mm.
- Para parafusos M12.



51490

36,00€

1.88	-	5	360

KIT DE EXTRATORES DE RÓTULAS



CABO PARA USAR COM UM MARTELO
FORQUILHAS: 11/16, 15/16" E 1-1/8"

53384

165,00€

7.30	-	2	62

EXTRATOR DE RÓTULAS HIDRÁULICO

- Visão geral: 100mm.
- Largura: 35mm.



REF.	DESCRIÇÃO				€
15253	FUSO HIDRÁULICO PARA NO. 53384/53638	1.35	1	10	62,00€

53208

126,00€

0.95	5	20	-

KIT DE PARAFUSO DE SEGURANÇA PARA BMW

22 PCS BMW 41-60



APLICAÇÕES

BMW Serie 1 F20/F21
BMW Serie 3 F30/F31
BMW Serie 4 F32/F34/F36

BMW Serie 5 F10/F11
BMW Serie 6 F12/F13
BMW Serie 7 F01/F02/F04

x20 41, 42, 43, 44, 45, 46, 47, 48, 49, 50, 51, 52, 53, 54, 55, 56, 57, 58, 59, 60

53207

118,00€

1.55	5	10	330

KIT DE PARAFUSO DE SEGURANÇA VW

23 PCS VW



x1 B51 / 6PT			
x1 B52 / 7PT			
x1 B53 / 8PT			
x1 B54 / 9PT			
x1 B55 / 10PT			
x1 B56 / 11PT			
x1 B57 / 12PT			
x1 B58 / 13PT			
x1 B59 / 14PT			
x1 B60 / 15PT			
x1 B61 / 16PT			
x1 B62 / 17PT	x1 ABC3 / 14PT		
	x1 ABC4 / 15PT		
	x1 ABC5 / 16PT		
	x1 ABC6 / 17PT	x1 ABC7 / 19PT	
		x1 ABC8 / 20PT	
		x1 ABC9 / 21PT	

52802

54,00€

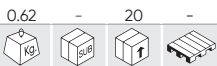

KIT DE PARAFUSO DE SEGURANÇA PARA BMW

10 PCS BMW



x1	30/13 PT
x1	31/15 PT
x1	32/16 PT
x1	33/17 PT
x1	34/18 PT

x1	35/19 PT
x1	36/20 PT
x1	37/21 PT
x1	38/22 PT
x1	40/23 PT

53328

76,00€

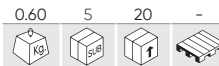

KIT DE PARAFUSO DE SEGURANÇA PARA MERCEDES

12 PCS

MERCEDES



APLICAÇÕES

A, B, C, GLK, CLC, CLS, CLK, E, SL, SLK, M, C300, C250, C350, E320, 204, 211, 212, R

51998

38,00€

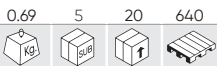

KIT DE CHAVES 3/8" PARA EXTRAÇÃO DE PORCAS

10 PCS 3/8" Cr-Mo

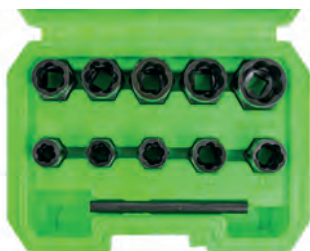

REPOSIÇÕES DISPONÍVEI

REF.	mm	Kg	SUB	QTD	€
16737	9mm	0.07	-	100	12,00€
11434	10mm	0.04	-	100	12,00€
11435	11mm	0.04	-	100	12,00€
11436	12mm	0.04	-	100	12,00€
11437	13mm	0.04	-	100	12,00€

REF.	mm	Kg	SUB	QTD	€
11438	14mm	0.06	-	100	12,00€
11439	15mm	0.06	-	100	12,00€
11440	16mm	0.06	-	100	12,00€
11441	17mm	0.08	-	100	12,00€
11442	19mm	0.09	-	100	12,00€

52962

42,00€

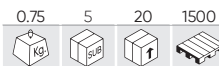

KIT DE CHAVES 3/8" PARA EXTRAÇÃO DE PORCAS 6-19MM

11 PCS 3/8" Cr-Mo



REPOSIÇÕES DISPONÍVEI

REF.	mm	Kg	SUB	QTD	€
11450	6mm	0.07	-	100	12,00€
12093	8mm	0.07	-	100	12,00€
11434	10mm	0.04	-	100	12,00€
11435	11mm	0.04	-	100	12,00€
11436	12mm	0.04	-	100	12,00€
11437	13mm	0.04	-	100	12,00€

REF.	mm	Kg	SUB	QTD	€
11438	14mm	0.06	-	100	12,00€
11439	15mm	0.06	-	100	12,00€
11440	16mm	0.06	-	100	12,00€
11441	17mm	0.08	-	100	12,00€
11442	19mm	0.09	-	100	12,00€

52823

124,00€

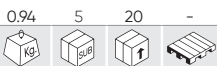

KIT DE PARAFUSO DE SEGURANÇA PARA AUDI

22 PCS VAG

A, B, C, E, F, G, H, I, J, L, M, N, P, Q, R, S, T, V, W, X



x20 A, B, C, E, F, G, H, I, J, L, M, N, P, Q, R, S, T, V, W, X

54317

124,00€

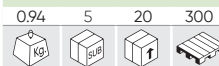

KIT DE PARAFUSO DE SEGURANÇA PARA VAG

22 PCS VAG CR-MO

521,522,523,524, 525,526,527,528, 529,530,531,532, 533,534,535,536, 537,538,539,540



x20 521,522,523,524,525,526,527,528,529,530,531,532,533,534,535,536,537,538,539,540

52153

46,00€

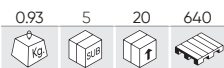

KIT DE CHAVES TWIST DE 1/2" PARA EXTRAÇÃO DE FÊMEAS



REPOSIÇÕES DISPONÍVEI

REF.	mm				€	REF.	mm				€
11443	17mm	0.02	25	100	14,00€	11446	23mm	0.03	25	100	15,00€
11444	19mm	0.02	25	100	14,00€	11447	27mm	0.03	25	100	15,50€
11445	21mm	0.02	25	100	15,00€						



54253

166,00€



KIT DE REMOÇÃO DE PARAFUSO DE SEGURANÇA DA RODA

Simple de usar, Master Kit é capaz de remover praticamente qualquer porca de travamento de roda. O kit inclui proteções, que protegem a roda contra qualquer dano. Muito eficaz, uma ferramenta obrigatória em qualquer oficina. O kit contém dois tamanhos de lâminas de corte de impacto para encaixar as porcas de travamento mais comuns, cortando o aro externo. Também estão incluídas três lâminas de dupla face para moldar diretamente na forma do soquete.

UNIVERSAL: Remove uma ampla variedade de tamanhos, tipos e perfis, incluindo aqueles com colares giratórios. Inclui driver de impacto e punção.

REPOSIÇÕES DISPONÍVEI

REF.	DESCRIÇÃO				€
16300	CORTADOR A E MANDRIL (REF. 54253)	0.15	-	100	7,60€
16301	CORTADOR B E MANDRIL (REF. 54253)	0.15	-	100	7,60€
16302	CORTADOR C (REF. 54253)	0.05	-	100	7,60€



54299

227,00€



KIT DE REMOÇÃO E INSTALAÇÃO DE BUCHAS DE RODA E ROLAMENTOS



	5,3cm		8,6x10,9cm
	5,8cm	B	8,2x10cm
	6,5cm		7,1x9,45cm
	6,6cm		8,9x17,6cm
A	Ø 2,3mm	C	9,9x17,6cm
	7,1cm		12x17,8cm
	7,3cm	D	Ø 2,3mm 9,5cm
	7,8cm	E	Ø 8,6mm 9,55cm
	8,3cm	F	2,4x28cm

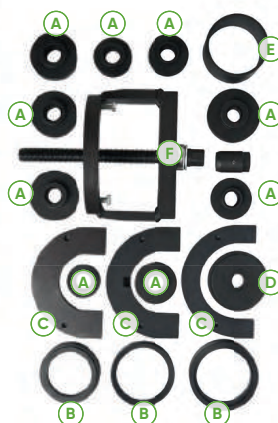

FERRAMENTA ESPECIAL

51919

89,00€



DESMULTIPLICADOR DE FORÇA COM AUMENTO

4 PCS



- Material: 40CR.
- Potência máxima : 5800Nm.
- Potência de trabalho: 3800Nm.
- Múltiple alcance 1:56.
- Inclui chaves de 32mm e 33mm de 1".

52796

98,00€

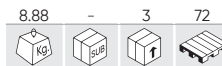

DESMULTIPLICADOR DE FORÇA ARTICULADO

5 PCS 6000 Nm



- Use um camião com tampa de cubo de roda e protetor.
- Previne danos ao aro.
- Único no mercado.
- Fácil adaptação a qualquer veículo universal.
- Útil para aparafusar sem esforço e desenroscar.

CONTÉM

- 1x chave 1" 32mm.
- 1x chave 1" 3mm.

51958

422,00€

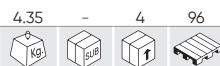

DESMULTIPLICADOR DE ROQUETE 3/4" + REDUCTOR DE 1/2"

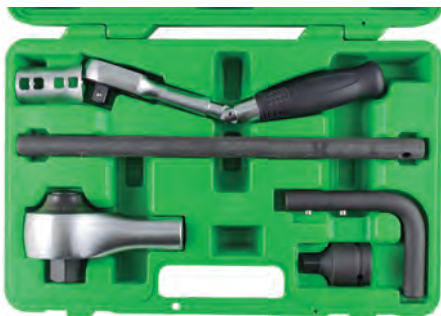

CONTÉM

- 1 Desmultiplicador de par.
- 1 Roquete manual.
- 1 Adaptador 1/2" M x 3/4" F.
- 1 Kit de desbloqueio.
- 1 ALAVANCA de extensão 90°.
- 1 ALAVANCA de extensão 350mm.

CARACTERÍSTICAS

- Relação de transmissão 1:4.
- Relação de par 1:3.3.
- Par máximo de entrada: 303Nm.
- Par máximo de saída: 1000 Nm.

52012

68,00€



DESMULTIPLICADOR DE FORÇA

1/2"

PARA AUTOMÓVEL



CONTÉM

- 1 desmultiplicador de par.
- 1 ALAVANCA de extensão 90°.
- Chaves 17mm, 19mm e 21mm.

- Alcance: 1:18
- Par máx. saída: 360Nm
- Par máx. torção: 800Nm

EXTRATOR

REF.	DESCRIÇÃO	mm	Max.	Min.					€
52642	EXTRATOR UNIVERSAL DE BOLA	17-22mm	60mm	20mm	1.32	5	10	660	32,00€
52699	EXTRATOR DE RÓTULAS	18-22mm	50mm	15mm	0.80	5	30	1140	22,00€



52642



52699

51123 91,00€

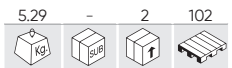

JOGO 5 EXTRATORES DE RÓTULA



- Jogo de extratores versáteis.
- Permite a fácil extração dos tipos mais populares de articulações de rótulas e demais.
- O tipo de separador de prensa de junta, permite o etiro da junta de rótula sem estragos aos carregadores e a outras peças que outro tipo de EXTRATORes podem causar.

53488 61,00€

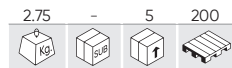

ALINHADOR DE QUEDAS (VAG)



x1	75mm	Seat - Toledo VW - Jeta / Golf
x1	85mm	Seat - Cordoba VW - Polo / 95>
x1	115mm	Chrysler - Voyager
x1	22mm	

51902 84,00€

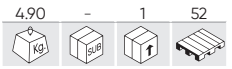

ALAVANCA DE EXTRAÇÃO DE RÓTULAS DE SUSPENSÃO COM ARTICULAÇÃO ESFÉRICA

- Comprimento: 118cm.
- Diâm. Tubo: 3,5cm.
- Distância de anclajes: 50, 45, 40, 35, 30 cm.
- Anclaje de 15x13cm.



REF.	DESCRIÇÃO	kg	sub	un	€
10953	REPOSIÇÃO ÂNCORA DE FIXAÇÃO PARA REF. 51902	0.83	-	25	12,50€

51119 62,00€

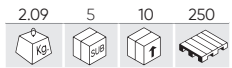

KIT DE 7 PEÇAS PARA SISTEMA DE INJEÇÃO - LAMBDA

7 PCS 1/2" 3/8"

x1	1/2"	29x9 ~ 90mm
x1	1/2" ~ 7/8"	50mm
x1	1/2"	27x12 ~ 78mm
x1	3/8" ~ 7/8"	6 ~ 90mm
x1	3/8" ~ 7/8"	6 ~ 80mm
x1	3/8" ~ 7/8"	30mm
x1	3/8" ~ 1"	74mm
x1	1" ~ 1/16"	74mm



52637 48,00€

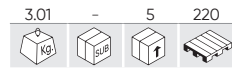

KIT DE EXPANSÃO PARA TUBOS DE ESCAPE

x1	1-1/8" - 1-3/4"
x1	1-1/2" - 2-1/2"
x1	2-1/8" - 3-1/2"



51491

154,00€



KIT DE 14 PEÇAS PARA O SISTEMA DE INJEÇÃO LAMBDA

14 PCS

17x78mm	12PT	Renault
19x78mm	12PT	VW, Polo, Audi, Seat, Mazda
20x78mm	6PT	Deschis, Japon
27x78mm	6PT	Deschis, Japon
21x90mm	12PT	Seat, Audi, VW, Skoda, Alfa Romeo, Mitsubishi
22x78mm	12PT	Seat, Audi, VW, Skoda, Opel
22x110mm	12PT	Mercedes, Citroën, Peugeot, Ford, Nissan, Mazda, Mitsubishi, Seat, Audi, VW...



51991

54,00€



ALINHADOR DE DIREÇÃO

- Comprimento total aberto: 1950mm.
- Comprimento total flexado: 1100mm.
- Medida do parafuso: M6x15mm.
- Tubo exterior de 20x20 de alumínio.
- Tubo interior de 16x16 de ferro zincado.



53118

231,00€

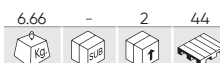

KIT PARA REMOÇÃO DE AMORTECEDOR

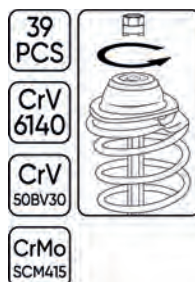

52822

32,00€

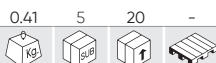

CHAVE PARA Sonda LAMBDA ARTICULADA 22MM



52849

8,50€



SET DE 2 GANCHOS PARA EXTRAIR BORRACHA DA TUBO DE DESCARGA



52852

6,80€

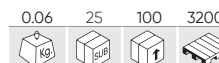

CONJUNTO DE 2 PEÇAS RISCADOR



51347

9,90€

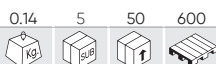

ESTETOSCÓPIO

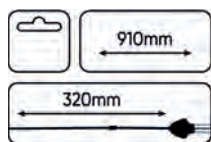

- Aumenta e localiza ruídos internos mecânicos e de passagem de fluidos.
- Localiza a fonte de ruído do motor rapidamente.
- Escuta os problemas de localização de fluidos de água, petróleo, gás ou vapor.
- Ponta à prova de golpes.



53249

192,00€

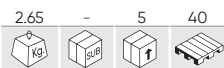

ESTETOSCÓPIO ELECTRÔNICO

Kit adequado para detecção de falhas em coletores de admissão/escape, injectores, radiadores, etc. Permite a auscultação de diversos pontos do veículo de forma simultânea facilitando o trabalho do operário na hora de encontrar e diagnosticar avarias. Sondas marcadas por cor que facilitam o trabalho do operário.

CARACTERÍSTICAS

Comprimento do cabo sensor: 4,8 m
 Comprimentos da sonda de áudio: 14 cm
 Baterias de 9V (incluída)
 Quantidade de sensores: 6
 Adequado para conector de 3,5 mm
 Comprimento ajustável do microfone: 21 cm

x1	Testadores de áudio	x6	Canais de microfone de caixa
x1	Capacetes	x1	Velcro de fixação para sensores
x6	Clipes de microfone	x1	Pilha quadradas



52293

98,00€

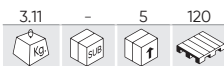

KIT DE EXTRAÇÃO DE POLIAS DE 30 PEÇAS

A	x1	H38x3 Pins - 20mmL
B	x1	H17x4 Pins - 30mmL
C	x1	3/8" Dr. x H10
D	x1	1/2" Dr. x H10
E	x9	M10xH12 (64mmL), T50xH12 (64mmL), H10xFH10 (68mmL), H8xH10 (75mmL), M8xH10 (75mmL), M10xH10 (75mmL), H10xH10 (75mmL), T40xH10 (75mmL), T50xH19 (75mmL)
F	x3	1/2" Dr. T50 - 17mm x T33 - 100mmL, 1/2" Dr. M10 - 17mm x T33 - 100mmL, 3/8" Dr. M10 - 12mm x T31 - 85mmL,
G	x4	1/2" Dr. T50 - 140mmL, 1/2" Dr. M10 - 140mmL, 1/2" Dr. T50 - 200mmL, 1/2" Dr. M10 - 200mmL
H	x5	H17xH21 (30mmL), H15xH28 (30mmL), H19xH28 (30mmL), H21xH28 (30mmL), H22xH28 (30mmL)
I	x2	H22 (30mmL), H17 (35mmL)
J	x3	H22x22mm x T33 (300mmL), H15x15mm x T33 (30mmL), 15mm x T33 (30mmL)

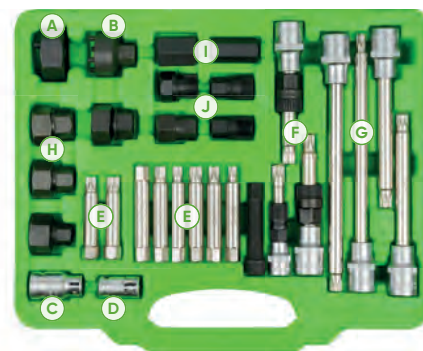

51259

58,00€

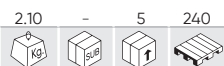

KIT DE EXTRAÇÃO DE POLIAS 18 PEÇAS

REPOSIÇÕES DISPONÍVEI

REF.	DESCRIÇÃO				€
10485	CHAVE PONTA XZN M10 PARA 51259	0.10	5	100	8,10€
10486	CHAVE PONTA TORX T50 CORREDIÇA PARA 51259	0.15	5	50	8,00€
10494	CHAVE D'EXTENSÃO 14CM PARA 51259	0.16	-	-	6,50€
10495	PONTA H10 PARA 51259	0.06	-	-	3,00€
10496	PONTA H8 PARA 51259	0.06	5	50	3,00€
10497	PONTA M10 PARA 51259	0.06	5	100	3,00€
10498	PONTA M8 PARA 51259	0.06	5	50	3,00€
10499	PONTA T40 PARA REF.51259	0.05	5	60	3,00€
10500	PUNTA T50 PARA 51259	0.06	5	100	3,00€
10501	CHAVE PONTA 3/8" M10 PARA 51259	0.08	5	100	8,10€
10502	PONTA M10 75MML PARA 51259	0.06	-	20	3,50€

CONTÉM

A	x3	T50x110mm (1/2"), M10x110 (1/2"), M10x90mm (3/8")	E	x1	1/2"x10mm
B	x1	M10x140mm	F	x1	M10x65mm
C	x2	19, 22mm	G	x6	T40, T50, M8, M10, H8, H10 (10x75mm)
D	x3	22x28, 19x28, 21x28mm	H	x1	H22

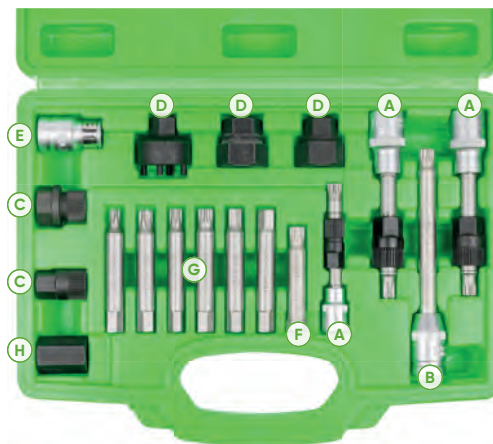

51495

59,00€

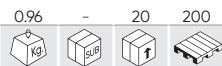

EXTRATOR DE BOBINA DE IGNIÇÃO PARA VW



- Para retirar e instalar as bobinas de encendido com tampa de motores de injeção de VW CYL 8 e 12 / 5 e 6 CYL, VW GOLF, BORA, 4 e 5 CYL. VW Passat, 6 CYL, Sharan VW, Touareg, Phaeton.
 - Para retirar e instalar as bobinas de encendido com etapa de potência de VW Polo, Golf 1.4, 1.6i, 1.4i CADDY, BORA 1.4, 1.6i Phaeton, Passat, Touran 1.6i, Transporter T4.



EXTRATOR DE CONEXÕES DE AQUECEDOR

REF.	DESCRIÇÃO				€
52816	EXTRATOR DE CONEXÕES DE AQUECEDOR - BOCA EM ÂNGULO - 235MM	0.27	6	36	28,10€
52817	EXTRATOR DE CONEXÃO DE AQUECEDOR- BOCA RETO 250MM	0.28	6	36	23,50€



52816



52817



52621

11,00€

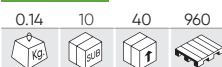

LIMPADOR DE TERMINAIS DE BATERIA



52319

8,80€



LIMPADOR DE TERMINAIS DE BATERIA



CHAVE DE VELA MAGNÉTICA

REF.	"	mm					€
52316	3/8"	250mm - Ø14mm	0.20	12	48	2880	18,90€
52317	3/8"	250mm - Ø16mm	0.30	12	48	2880	19,90€



CHAVE DE VELAS HEX.

REF.	"	mm					€
10054	1/2"	16mm	0.08	10	100	-	2,90€
10055	1/2"	21mm	0.14	10	100	-	3,90€



52691

54,00€



CHAVE DE VELA ARTICULADA

COM FIXAÇÃO MECÂNICA

3/8"	8mm (82mm)	3/8"	12mm (82mm)
3/8"	9mm (82mm)	3/8"	14mm (82mm)
3/8"	10mm (82mm)	3/8"	16mm (82mm)



CHAVE CACHIMBO ARTICULADA PARA VELAS DE IGNIÇÃO

REF.	DESCRIÇÃO					€
54381	CHAVE CACHIMBO ARTICULADA PARA VELAS DE IGNIÇÃO 14 MM 0.35	10	40	-	-	5,00€
54382	CHAVE CACHIMBO ARTICULADA PARA VELAS DE IGNIÇÃO 16 MM 0.35	10	40	-	-	5,00€
54383	CHAVE CACHIMBO ARTICULADA PARA VELAS DE IGNIÇÃO 21 MM 0.39	10	40	-	-	5,00€



N

54380

0.00	10	50	-

119,00€



N

CONJUNTO DE 9 SOQUETES COM CABO EM T (7-19MM)

REPOSIÇÕES DISPONÍVEIS

REF.	mm				€	REF.	mm				€
16430	7	0.17	10	50	20,50€	16565	14	0.17	10	50	19,50€
16431	8	0.17	10	50	20,50€	16566	19	0.17	10	50	22,50€
16432	10	0.17	10	50	20,50€						
16433	11	0.17	10	50	20,50€						
16434	13	0.17	10	50	20,50€						
16435	15	0.17	10	50	21,50€						
16436	17	0.17	10	50	21,50€						

9 PCS CrV 7, 8, 10, 11, 13, 14, 15, 17, 19mm



51501

0.88	5	20	240

38,00€

KIT PARA EXTRAÇÃO DE AIRBAGS

12 PCS

- Pontas 0.5 PC 1/4" x 87mm (L):
 2x Torx: T25 (para BMW), T30 (para Audi, Opel, Renault, VW).
 2x Torx (Inviolable): T25H (Para BMW), T30H (Para AUDI, BMW, Mercedes, Opel).
 1x Hex: 5 mm (Para AUDI).

- 0.7 PC Ferramenta extração:
 1x para Airbag conductor. 1999-04 nuevo estilo de carroçeria de VW Passat, JETTA, GOLF.
 2x Para VW Passat B5, POLO, LUPO; AUDI A4, A6, Skoda Superb.
 2x Para VW GOLF 4, New Beetle, SEAT, SKODA FABIA, AB Oktavia BJ.99.
 1x Para VW GOLF 4 (BJ, 1998-2004), VW PASSAT BJ.1997 AB, AB BORA BJ.1999.
 1x Para U.A VW modelle: AB PASSAT BJ.2000.

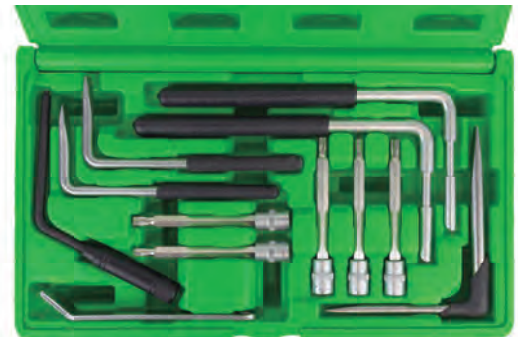

53388

1.50	-	5	120

90,00€

TRUSĂ DE 52 PEÇAS PARA EXTRAÇÃO DE EQUIPAMENTOS DE AUDIO

52 PCS

BLAUPUNKT, CLARION, SKODA, BMW, AUDI, GFUNDIG, JVC, PIONEER, VOLKSWAGEN, MERCEDES, OPEL DOPPEL-KUGEL-INBUS, PORSCHE, BECKER, KENWOOD, SONY, PANASONIC, FIAT BRAVA, FORD.



51126

18,00€

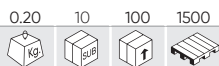

KIT DE ACESSÓRIOS PRA EXTRAIR EQUIPAMENTOS ÁUDIO

10 PCS

BLAUPUNKT, PEUGEOT, CLARION, SKODA, ALPINE, BMW, OPEL, AUDI, GFUNDIG VDO, JVC, PIONEER, VOLKSWAGEN, MERCEDES, PORSCHE, RENAULT, BECKER.



53393

118,00€

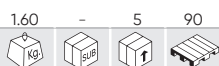

KIT DE 23 EXTRATORES DE TERMINAIS

23 PCS



BMW, AUDI, VOLKSWAGEN, MERCEDES, OPEL, PORSCHE, JAGUAR, SAAB, SEAT, FORD, SKODA, RENAULT, CITROËN, CHRISLER, FIAT, HONDA, MAZDA, MITSUBISHI, TOYOTA.

53391

86,00€



KIT DE 19 EXTRATORES DE TERMINAIS

19 PCS



x19 A, B, C, D, E, F, G, H, I, J, K, L, A1, B2, C3, D4, E5, F6, G7

51986

11,90€



RECÂMBIO DE GAS 200ML

200ml



51920

18,00€

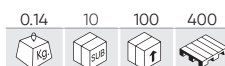

MAÇARICO



53474

94,00€

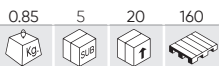

PISTOLA ESTROBOSCÓPICA DIGITAL

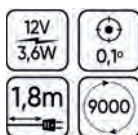

53240

58,00€

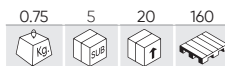

PISTOLA ESTROBOSCÓPICA



53663

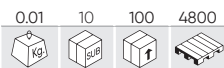

8,00€

FERRAMENTA DE DESMONTAGEM DE CONECTORES PARA VAG



- Ferramenta para desmontar conectores em veiculos do grupo VAG sem danificá-los.



KIT REPARAÇÃO ROSCAS HELICÓIDAS

53041

37,60€

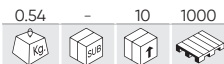

M14 x 1,25

ESPECIAL VELA DE IGNIÇÃO



51898

139,00€

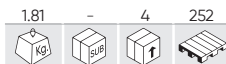

M18 x 2,5



51899

137,00€



M20 x 2,5



51896

82,00€

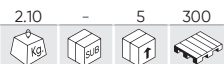

115 PCS

KIT REPARADOR DE ROSCAS HELICÓIDAS



CONTÉM POR MEDIDA

Broca.
Macho de roscar.
Chave helicoidal.
Punção de ruptura.
Conjunto helicóide aço Inox.

CONTÉM

25 x M5x0.8
25 x M6x1
25 x M8x1.25
25 x M10x1.5
10 x M12x1.75

51897

122,00€



39 PCS

KIT REPARADOR DE ROSCAS HELICÓIDAS



CONTÉM POR MEDIDA

Broca.
Macho de roscar.
Chave helicoidal.
Punção de ruptura.
Conjunto helicóide aço Inox.

CONTÉM

9 x M12x1.75
9 x M14x2
9 x M16x 2.0

HELICÓIDAS DE SUBSTITUIÇÃO

REF.	DESCRIÇÃO					€
52016	HELICÓIDAI DE SUBSTITUIÇÃO M5 X 0,8	0.01	10	300	72000	2,10€
52017	HELICÓIDAI DE SUBSTITUIÇÃO M6X1.0	0.01	500	1000	21000	2,40€
52018	HELICÓIDAI DE SUBSTITUIÇÃO M8X1.25	0.01	10	500	21000	2,60€
52019	HELICÓIDAI DE SUBSTITUIÇÃO M10X1.5	0.01	10	500	21000	3,20€
52021	HELICÓIDAI DE SUBSTITUIÇÃO M12X1.75	0.05	100	500	21000	3,40€
52022	HELICÓIDAI DE SUBSTITUIÇÃO M14X2.0	0.03	100	300	12600	4,50€
52023	HELICÓIDAI DE SUBSTITUIÇÃO M16X2.0	0.05	60	300	12600	6,60€
52024	HELICÓIDAI DE SUBSTITUIÇÃO M18X2.5	0.08	-	10	21000	10,60€
52025	HELICÓIDAI DE SUBSTITUIÇÃO M20X2.5	0.10	-	60	21000	13,00€

FERRAMENTA ESPECIAL

50793

94,00€



60
PCS

KIT FERR. CORTE 60 P. MACHOS E CAÇONETES. MÉTRICO E PULGADA

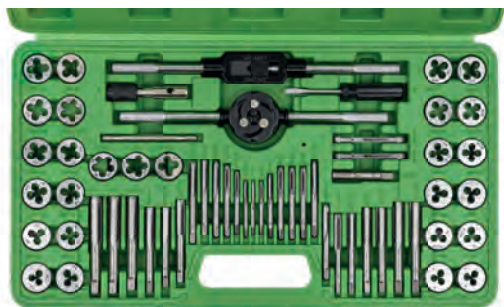

- x1 NPT macho (pol.): 1/8-27.
- x1 NPT caçonete (pol.): 1/8-27.
- x1 Porta Macho misto tip: M3 ~ M12 e 3/16 "a 1/2".
- x1 Porta Macho misto tip: M3 ~ M6 ~ 6-32 e 4-40
- x1 Porta caçonetes misto: Ø25mm
- x1 Chave de fenda
- x1 Jogo de galgas métricas para rosca.
- x1 Jogo de galgas métricas para rosca.
- x10 Machos (métricos): M3x0.5, M4x0.7, M5x0.8, M6x1.0, M7x1.0, M8x1.25, M9x1.25, M10x1.0, M10x1.5, M12x1.75.
- x10 Machos UNC (pulgadas): 4-40, 10-24 6-32, 8-32, 12-24, 1/4-20, 5/16-18, 3/8-16, 7/16-14, 1/2-13.
- x6 Caçonetes UNF (pulgadas): 10-32, 1/4 -28, 5/16-24, 3/8-24, 7/16-20, 1/2-20.
- x10 Caçonetes (métricos): M3x0.5, M4x0.7, M5x0.8, M6x1.0, M7x1.0, M8x1.25, M9x1.25, M10x1.0, M10x1.5, M12x1.75.
- x10 Caçonetes UNC (pulgadas): 4-40, 10-24 6-32, 8-32, 12-24, 1/4-20, 5/16-18, 3/8-16, 7/16-14, 1/2-13.
- x6 Caçonetes UNF (pulgadas): 10-32, 1/4-28, 5/16-24, 3/8-24, 7/16-20, 1/2-20.

50792

105,00€



58
PCS

KIT FERR CORTE 58P. MACHOS E CAÇONETES RECOBERTAS DE TITÂNIO



- x1 Macho e 1 caçonete tipo NPT: 1/8-27.
- x1 Macho e 1 caçonete tipo TPN: 1/8-27.
- x1 Porta Macho: M4 ~ M12.
- x1 Porta Machos tipo: M3 ~ M6.
- x1 Porta caçonete: 25mm O / D.
- x1 Chave de fenda.
- x1 Jogo de galgas para rosca.
- Machos: M2x0.4 (x2), M3x0.6 (x2), M3x0.5 (x2), M3.5x0.6 (x2), M4x0.75 (x2), M4x0.7 (x2), M5x0.8 (x2), M6x0.75 (x2), M6x1.0 (x2), M7x0.75 (x2), M7x1.0 (x2), M8x1.0 (x2), M8x1.25 (x2), M10x1.25 (x2), M10x1.5 (x2), M12x1.25 (x2), M12x1.75 (x2)
- x17 Caçonetes: M2x0.4, M3x0.6, M3x0.5, M3.5x0.6, M4x0.75, M4x0.7, M5x0.8, M6x0.75, M6x1.0, M7x0.75, M7x1.0, M8x1.0, M8x1.25, M10x1.25, M10x1.5, M12x1.25, M12x1.75

51496

8,00€

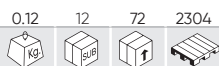

EXTRATOR DE PARAFUSOS PARTIDOS

- Nº1 1/8" - 1/4" (M 3-6)
- Nº2 1/4" - 5/16" (M 6-8)
- Nº3 5/16" - 7/16" (M 8-11)
- Nº4 7/16" - 9/16" (M 11-14)
- Nº5 9/16" - 3/4" (M 14-18)



53502

38,70€

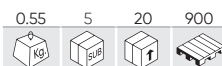

KIT EXTRATOR DE MACHOS DE ROSCAR QUEBRADOS

- #2 M5
- #3 M6
- #4 M8
- #5 M10
- #6 M12
- #7 M14
- #8 M16
- #9 M20
- #10 M22



53055

33,00€

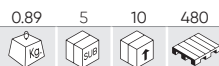

CORTADOR E REBITADOR DE CORRENTE DE MOTOCICLETAS

QUEBRA-VIDROS 2.2mm, 2.9mm, 3.8mm



54280



156,50€

7 PCS N

KIT DE REPARACIÓN DE ROSCAS DE BUJÍAS

REPOSIÇÕES DISPONÍVEI

REF.	DESCRIÇÃO				€
16237	M8X1,0 115MM	0.10	10	40	23,00€
16238	M10X1,0 115MM	0.10	10	40	23,00€
16239	M12X1,25 140MM	0.15	10	40	23,00€
16240	M12X1,25 270MM	0.30	10	40	26,00€
16241	M14X1,25 140MM	0.15	10	40	23,00€
16242	M14X1,25 270MM	0.35	10	40	26,00€
16243	M18X1,5 90MM	0.10	10	40	23,00€

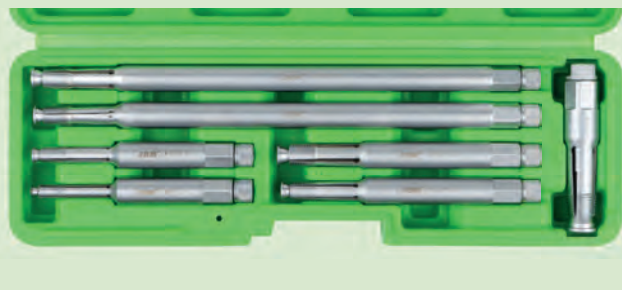

52833

39,30€

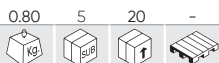

KIT DE CHAVES EXTRACTOR DE PERNOS 1/2"

1/2"



REPOSIÇÕES DISPONÍVEI

REF.	mm				€
14211	6mm	0.10	20	100	11,00€
14212	8mm	0.10	20	100	12,00€
14213	10mm	0.20	20	100	12,00€
14214	12mm	0.20	20	100	14,00€

53524

51,00€

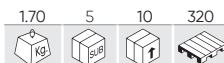

KIT DE 4 UNIDADES CORTAR PORCAS



REPOSIÇÕES DISPONÍVEI

REF.	mm					€
14049	9-12 mm (1/8" - 1/2")	0.10	-	50	-	8,00€
14050	12-16 mm (1/2" - 5/8")	0.20	-	50	-	10,50€
14051	16-22 mm (5/8" - 7/8")	0.44	25	50	-	18,00€
14052	22-36 mm (7/8" - 1-1/16")	0.65	-	20	-	19,50€

53652

53,00€



KIT DE REPARAÇÃO DE ROSCA PARA PINOS DE RODA

REPOSIÇÕES DISPONÍVEI

REF.	DESCRIÇÃO				€
14340	PARAFUSO DE REPARO M12X1.25 - PSA (REF.53652)	0.05	-	20	10,50€
14341	PARAFUSO DE REPARO M12X1.5 - MERCEDES BENZ / BMW (REF.53652)	1.14	-	20	10,50€
14342	PARAFUSO DE REPARO M12X1.75 - VOLVO (REF.53652)	1.12	-	20	10,50€
14343	PARAFUSO DE REPARO M14X1.5 - VAG (REF.53652)	1.29	-	20	10,50€
14344	DISCO DE REPARO M12X1.25 (REF.53652)	0.49	-	20	11,00€
14345	DISCO DE REPARO M12X1.5 (REF.53652)	0.50	-	20	11,00€
14346	DISCO DE REPARO M14X1.5 (REF.53652)	0.46	-	20	11,00€



54003

104,00€



KIT DE REPARAÇÃO DE ROSCAS INTERNAS E EXTERNAS



- x1 M14x1.5
- x1 M16x1.5
- x1 M18x1.5
- x1 M20x1.5
- x1 M22x1.5
- x1 M24x1.5
- x1 M27x2.0
- x1 M28x1.5



53665

19,00€

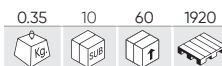

CORTADOR DE CORRENTE DE MOTOCICLETA (25-60)



53666

28,00€

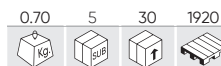

CORTADOR DE CORRENTE DE MOTOCICLETA (60-100)



53054

6,00€



CHAVE ESPECIAL PARA MOTAS



53086

9,00€



CHAVE PARA MOTAS



YAMAHA, KAWASAKI, BMW, SUZUKI, HONDA

52454

12,90€



EXTRATOR DE BRAÇO DE LIMPA-PÁRA-BRISAS



53664

38,00€



EXTRATOR DE POLIAS UNIVERSAL



Eixo de 16 mm de diâmetro com esfera centralizadora e cabeça de parafuso hexagonal de 24 mm.

51125

88,00€

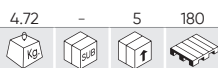

KIT DE EXTRATORES DE GUILHOTINA

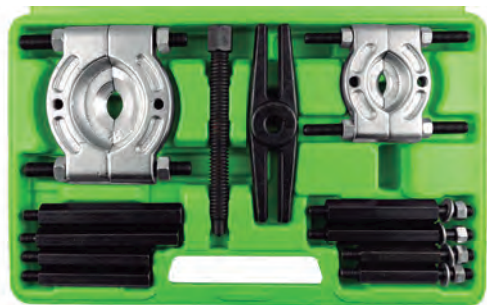

SET POLEGADA:

- x2 1/4", com 30mm e 50mm.
- x1 Parafuso de 3/8" de 9,5x125 - 24 UNF.
- x1 Cabeça de 3/8" x 16 UNC.

SET 2 POLEGADA:

- x1 1/4" - 3 1/2", com 50x75mm.
- x1 Parafuso de 1/2" de 12,7x135 - 20 UNF.
- x1 Cabeça de 3/8" x 16 UNC.

EXTRATOR DE GUILHOTINA

REF.	DESCRIÇÃO	Kg	SUB	€
52626	75-105mm	3.65	- 5 800	46,00€
52627	105-150mm	6.50	- 2 231	120,00€



EXTRATOR DE 2 GARRAS

REF.	DESCRIÇÃO	—	I					€
52727	EXTRATOR DE 2 GARRAS 25-70MM	25-70mm	50mm	0.20	10	60	1200	34,60€
52728	EXTRATOR DE 2 GARRAS 25-130MM	25-130mm	110mm	1.20	5	10	500	68,00€
52729	EXTRATOR DE 2 GARRAS 60-200MM	60-200mm	160mm	3.26	-	3	240	128,00€
52730	EXTRATOR 2 GARRAS 80-350MM	80-350mm	225mm	8.55	-	2	108	288,00€

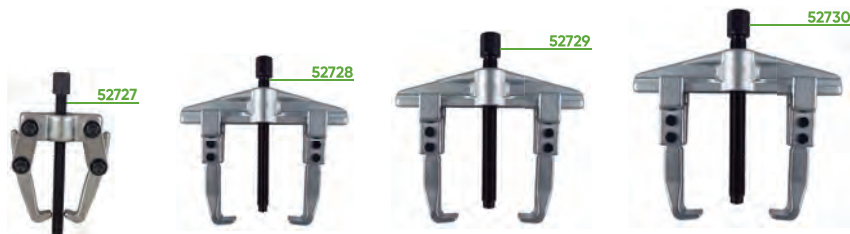

REF.	DESCRIÇÃO					€
53146	EXPOSITOR DE EXTRATORES	0.70	5	10	140	30,50€

EXTRATOR DE 3 GARRAS

REF.	DESCRIÇÃO	—					€
52731	EXTRATOR DE 3 GARRAS DE 50-100MM	50-100mm	0.90	4	24	504	38,00€
52732	EXTRATOR DE 3 GARRAS 70-150MM	70-150mm	2.54	5	20	200	58,00€
52733	EXTRATOR DE 3 GARRAS DE 95-200MM	95-200mm	5.20	-	4	112	98,00€



EXTRATOR DE 3 GARRAS CONVERSÍVEL EM 2 REVERSÍVEL

REF.	DESCRIÇÃO	T					€
52010	EXTRATOR DE 3 GARRAS CONVERSÍVEL EM 2 REVERSÍVEL 2T	2T	0.50	4	40	360	80,00€
52296	EXTRATOR DE 3 GARRAS CONVERSÍVEL EN 2 REVERSÍVEL 5T	5T	1.57	4	8	120	119,00€
52297	EXTRATOR DE 3 GARRAS CONVERSÍVEL EM 2 REVERSÍVEL 7T	7T	3.33	-	6	36	172,00€
52298	EXTRATOR DE 3 GARRAS CONVERSÍVEL EM 2 REVERSÍVEL , GARRA CURTA E LONGA	2T	2.65	3	6	396	177,00€



53701

188,00€

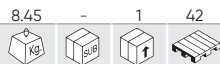

KIT UNIVERSAL DE EXTRATORES DE 2/3 GARRAS

- Faixa de trabalho 2 pernas: 45-120mm.
- Faixa de trabalho 3 pernas: 50-130mm.
- Profundidade da faixa 100, 200, 250 mm.

CONTÉM

- Guia central de 3 pernas.
- Guia central de 2 pernas.
- Pino 275mm.
- Pino 165mm.
- Pernas longas com alças: 250mm.
- Pernas médias com alças: 200mm.
- Pernas curtas com alças: 100mm.

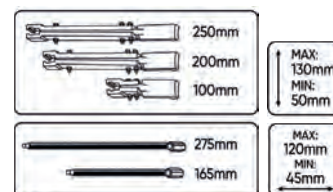

REF. DESCRIÇÃO

REF.	DESCRIÇÃO	kg	SUB	QTD	€
14611	GARRA DE CAPTURA PARA REF. 53701	0.10	-	50	12,00€
14612	PARAFUSO 165 MM PARA REF. 53701	0.15	-	20	11,00€
14613	PARAFUSO 275 MM PARA REF. 53701	0.30	-	20	13,50€

53062

99,00€

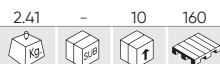

KIT DE EXTRATORES DE ROLAMENTOS COM ESFERAS FALSAS

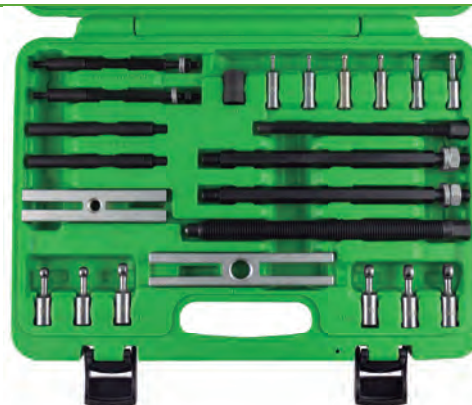

51140

64,00€



EXTRATOR DE POLIA

- Desenhado para manter a polia da árvore de cames fixa.
- Permite o ajuste do eixo central quando se dá a junção.
- Usando a barra roscada para extrair a polia.
- Parafusos de fixação: M6, M8.



51500

29,00€



EXTRATOR DE POLIAS ENCRAVADAS

- Apto para o uso em cambotas, alternadores, unidades de A/C e bombas de água.
- Os braços de perfil baixo permitem um fácil acesso a zonas difíceis do motor.
- Desenhado para a extração da cambota encravada, amassada e de polias auxiliares.
- Rang: 40-160mm.



40-168mm

52494

227,00€

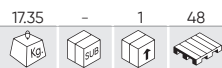

FERRAMENTA UNIVERSAL DE REMOÇÃO / INSTALAÇÃO DE ROLAMENTOS E CASQUILHOS

- Útil para instalar e desinstalar casquilhos e rolamentos de suspensão.
- Peças de duplo tamanho e varilhas de rosca de diferentes métricos.
- Medidas: M10, M12, M14, M16, M18.

ADAPTADORES (DIÂMETRO EXTERNO/INTERNO):

90/80, 85/75, 82/72, 80/70, 78/68, 76/66, 74/64, 72/62, 70/60, 68/58, 66/56, 64/54, 62/52, 60/50, 58/48, 56/46, 54/44, 52/42, 50/40, 48/38, 46/36, 44/34

REF.	DESCRIÇÃO	Kg	Vol	Qtd	Compr	€
12926	FERRAMENTA UNIVERSAL DE REMOÇÃO M10 P/52494	0.46	-	20	1500	21,50€
12927	FERRAMENTA UNIVERSAL DE REMOÇÃO M12 P/52494	0.52	-	20	-	21,50€
12928	FERRAMENTA UNIVERSAL DE REMOÇÃO M14 P/52494	0.60	-	30	1500	22,00€
12929	FERRAMENTA UNIVERSAL DE REMOÇÃO M16 P/52494	0.66	-	20	-	23,00€
12930	FERRAMENTA UNIVERSAL DE REMOÇÃO M18 PARA REF.52494	0.89	-	30	-	23,50€



51124

88,00€

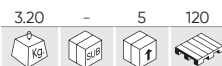

KIT DE EXTRAÇÃO DE ROLAMENTOS

5 PCS

UNIVERSAL



CONTÉM

- EXTRATOR Universal (38,5mm).
- Adaptador de 3/8" a 1/2" (10-14mm).
- Adaptador de 9/16" a 11/16" (15-19mm).
- Adaptador de 5/8" a 1" (18-25mm).
- Adaptador de 1" a 1 1/4" (25-32mm).

52624

28,00€



EXTRATOR DE POLIAS ARMÔNICO

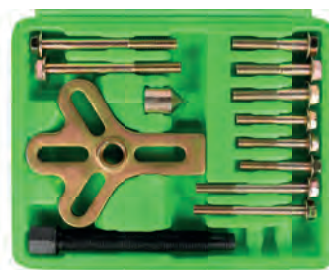

x2	Parafuso 5/16" de 4"
x2	Parafuso 1/4" de 3"
x3	Parafuso 5/16" de 2"
x3	Parafuso 1/4" de 2"
x1	5" Parafuso de pressão de alu
x1	Punta giratoria 3/4"

53058

193,00€

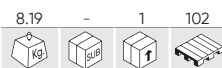

KIT DE MONTAGEM PARA ROLAMENTOS



x49	Ø 18, 19, 20, 21, 22, 23, 24, 25, 26, 27, 28, 29, 30, 31, 32, 33, 34, 35, 36, 37, 38, 39, 40, 41, 42, 43, 44, 45, 46, 47, 48, 49, 50, 51, 52, 53, 54, 55, 56, 57, 58, 59, 60, 61, 62, 63, 64, 65, 74mm
x1	Cabo de metal (para uso com martelo) com diâmetro de Ø 12mm

53056

127,00€



KIT DE EXTRAÇÃO E INSTALAÇÃO DE ROLAMENTOS



Ø	x9	Ø 55.5, 59, 62, 65, 66, 71.5, 73, 78, 84mm	Ø	x1	Ø 69mm
Ø	x2	Ø 75.5, 83mm	Ø	x1	295mm

FERRAMENTA ESPECIAL

52551

151,00€

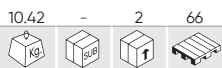

KIT PARA EXTRAÇÃO DE ROLAMENTOS



x13 Disco: 50, 55, 60, 64, 67, 70, 72, 74, 75, 78, 82, 84, 88mm

x4 Cilindros: 76, 82, 92, 101mm

x1 Parafuso: 32mm

x1 Porca: 38mm

x1 Parafuso reforçado para uso com ferramenta de impacto.

x1 Eixo de aço-fosfato para evitar corrosão.

53463

98,00€

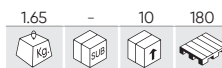

KIT DE EXTRAÇÃO DE BRAÇO DE LIMPA PRARA-BRISAS



VW: Polo, Lupo, Touareg, Porsche Cayenne.
Opel: Astra G, Zaphira B, Corsa C, Vectra C.
Honda: Jazz, CRV, FRV, Accord, Turnier.
BMW: 5º Modelo de EU 39 a 2005. 7º Modelo de E 38 a 2005
Audi: A3, A4, A5, A6. Audi Q7.
Ford: Galaxy, Alhambra.
Mercedes: A-Class, B-Class.

51349

37,30€

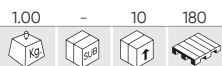

KIT PARA INSTALAÇÃO DE ROLAMENTOS



x13 42 - 38mm, 40 - 35mm, 36 - 32mm, 30 - 28mm, 24 - 22mm, 27 - 25mm, 18 - 16mm, 20 - 18mm, 22 - 20mm, 12 - 10mm, 14 - 12mm, 16 - 14mm, 17 - 15mm

53059

52,00€

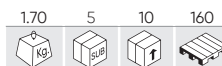

KIT DE INSTALAÇÃO DE ROLAMENTOS E FREIOS INTERIORES



x9 Ø 39,5, 44,5, 50, 59, 63, 65, 72, 76, 81mm

52056

66,00€



KIT DE 8 CHAVES 1" DESMULTIPLICADOR DE FORÇA

REPOSIÇÕES DISPONÍVEI

REF.	DESCRIÇÃO	Kg	Box	Qtd	€
16385	CHAVE 22MM 1" DESMULTIPLICADOR DE FORÇA	0.50	-	50	10,00€
16386	CHAVE 24MM 1" DESMULTIPLICADOR DE FORÇA	0.45	-	50	11,50€
10674	CHAVE 27MM 1" DESMULTIPLICADOR DE FORÇA	0.59	-	50	9,50€
10675	CHAVE 30MM 1" DESMULTIPLICADOR DE FORÇA	0.55	-	50	9,50€
10672	CHAVE 32MM 1" DESMULTIPLICADOR DE FORÇA	0.66	-	50	9,50€
10673	CHAVE 33MM 1" DESMULTIPLICADOR DE FORÇA	0.67	-	50	9,50€
16388	CHAVE 38MM 1" DESMULTIPLICADOR DE FORÇA	0.70	-	50	11,50€
16389	CHAVE 41MM 1" DESMULTIPLICADOR DE FORÇA	0.75	-	-	11,50€



FERRAMENTAS DE SINCRONISMO

- 244 FIAT/ALFA ROMEO
- 249 BMW/MINI
- 258 PSA
- 261 FORD
- 267 JAGUAR/LAND ROVER
- 269 JEEP/CHRYSLER
- 270 MERCEDES-BENZ
- 273 RENAULT/DACIA/NISSAN
- 278 OPEL/VAUXHALL
- 283 VAG
- 295 OUTRAS
- 297 FERRAMENTAS ADICIONAIS



53303

89,00€



KIT DE BLOQUEIO FIAT / OPEL

MARCAS	FIAT: 1.9D/JTD (MOTOR PEUGEOT), 2.4D. ALFA ROMEO: 145, 146, 156 JTD. GM: GM 1.3, 1.6, 1.9, 2.0, 2.4 CDTI (2004 -).
FERRAMENTAS OEM	EN-46789 (1), EN-46789-100 (2), EN-46785 (3), EN-46788 (4), EN-46781 (5), EN-46789 (6)
CÓDIGOS DE MOTOR	GM: K1.3 CDTI Z13DT COMMON RAIL ENGINE. 1.9 CDTI / 04-12 - Z19DT Z19DTH Z19DTJ Z19DTL 2.0 CDTI / 08-12 - A20DT LBS / LBX / LBY / LCD.V SAAB: 1.9 TID.

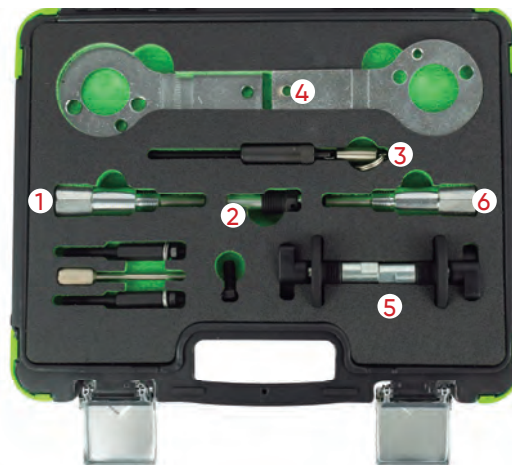

53304

279,00€



KIT DE BLOQUEIO FIAT

MARCAS	FIAT
FERRAMENTAS OEM	1 860 874 000 (1), 1 860 895 000 (2), 1 860 898 000 (3), 1 860 905 000 (4), 1 860 845 000 (5)
CÓDIGOS DE MOTOR	PETROL: FIAT BRAVA , BRAVO, BARCHETTA, CARGO, COUPE, MAREA, PALIO, WEEKEND, PUNTO, MULTILA, STILO, IDEA, DO-BLO TWIN CAM ENGINES - 1.2, 1.4, 1.6, 1.8, 16V GASOIL: FIAT BRAVA, BRAVO, MAREA, WEEKEND, PALIO, PUNTO, MULTIPLA, DOBLO, ULYSSE, DUCATO, STILO JTD DIESEL ENGINES - 1.9D/TD . 1.9JTD . 2.4TD/JTD.

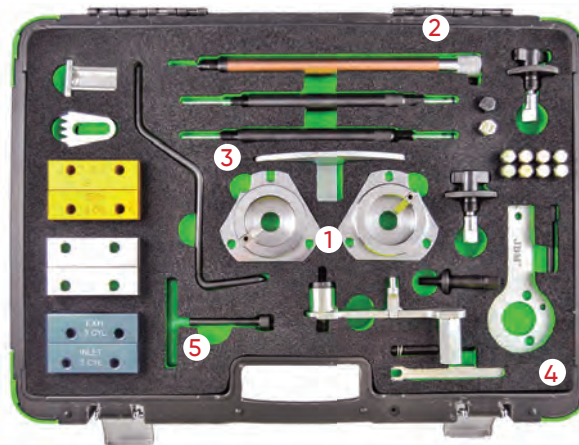

53306

53,00€



KIT DE BLOQUEIO FIAT 1.2 16V

MARCAS	FIAT: FIAT 1.2L 16V, FIAT PUNTO / BRAVA / BRAVO / STILO
FERRAMENTAS OEM	1860992000 (1) (2), 1871000900 (3), 1860987000 (4), 186985000 (5)
CÓDIGOS DE MOTOR	176 B9.000, 182 B2.000, 188 A5.000

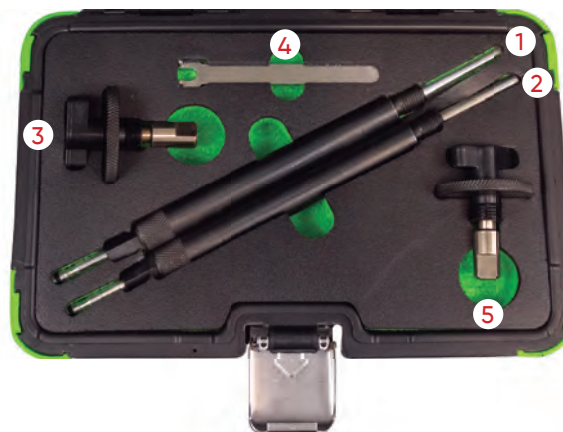

53308

55,00€

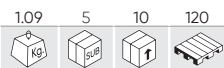

KIT DE BLOQUEIO ALFA ROMEO

MARCAS	ALFA ROMEO: 145,146,147,155,156, 1.4 1.6 1.8 2.0 TS, 1.4/1.6 16V; 145/146/147/155/156 (96-10), 1.8 16V; 145/146, (96-01), 155/156 (96-06), SPIDER/GTV (98-05), 2.0 16V; 145/146 (96-01), 147 (01-10), 155/156 (95-02), 166 (98-07), SPIDER/GTV (96-05), PÚRPURA / PURPLE: 1.4, 1.6 // AZUL / BLUE: 1.8, 2.0
FERRAMENTAS OEM	1822149000 (1), 1822154000 (2), 1825041000 (3), 1825042000 (4)
CÓDIGOS DE MOTOR	Z1.4/1.6-321.02, 321.03, 321.04, 335.03, 676.01 1.8/2.0-323.01, 672.04, 162.01, 323.10, 671.06, 322.01, 671.02, 322.05, 341.03, 363.01.

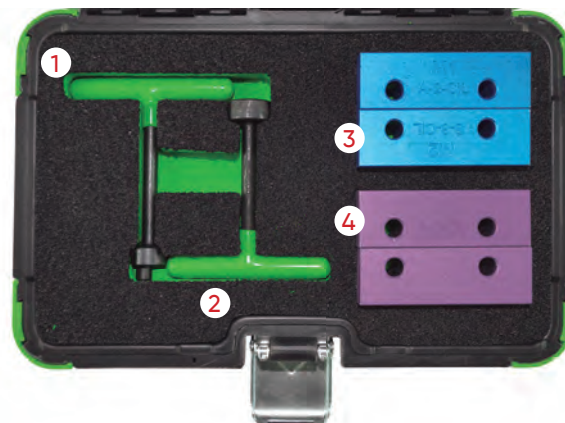

53309

285,00€



KIT DE BLOQUEIO ALFA/FIAT/LANCIA 1.4, 1.6, 1.8, 2.0 16V

MARCAS	ALFA ROMEO: 145,146,147,155,156, 1.4 1.6 1.8 2.0 TS, 1.4/1.6 16V; 145/146/147/155/156 (96-10), 1.8 16V; 145/146, (96-01), 155/156 (96-06), SPIDER/GTV (98-05), 2.0 16V; 145/146 (96-01), 147 (01-10), 155/156 (95-02), 166 (98-07), SPIDER/GTV (96-05), PURPUR: 1.4, 1.6 // BLAU: 1.8, 2.0 FIAT: BARCHETTA (96-00), BRAVA (95-00), BRAVO (95-0 0), COUPE (96-01), MAREA (96-00), MAREA WEEKEND (96-00), PUNTO/PUNTO CLASSIC (99-06), STILO (01-08) LANCIA: DEDRA (95-99), DELTA (96-99), KAPPA (98-02), LYBRA (99-06).
FERRAMENTAS OEM	1.4 16V: 335.03 1.6 16V: 321.02, 321.03, 321.04, 372.03, 676.01 1.8 16V: 322.01, 322.05, 671.06, 182A2.000, 183A1.000, 183A6.000, 188A6.000, 192A4.000 2.0 16V: 162.01, 323.01, 323.1, 341.03, 363.01, 672.04 2.0 20V: 175A3.000, 182A1.000, 182B7.000, 185A8.000.

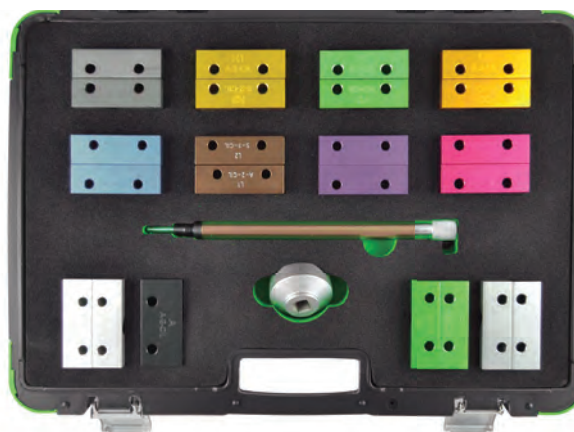

53310

498,00€



KIT DE BLOQUEIO FIAT/ALFA/LANCIA

MARCAS	ALFA FIAT LANCIA	ALLA, BARCHETTA, BRAVO, BRAVA, COUPE, DELTA, DEDRA, PUNTO, SPIDER, GT
FERRAMENTAS OEM	1860845000 (1), 1822154000 (2), 1860905000 (3), 1860992000 (4), 1860895000 (5), 1860874000 (6), 1860985000 (7), KM571A (8), 1 860 896 000 (9), 0153A (10)	
CÓDIGOS DE MOTOR	1.2 / 16V, 1.4 / 12V, 1.6 / 16V, 1.6 ECO. 1.8, 2.0 / 16V, 2.0 / 20V, 2.4 / 20V, 3.0 / V6.	



53312

127,00€



KIT DE BLOQUEIO FIAT/ALFA/FORD

MARCAS	FIAT: NEW 500 (07-09), IDEA (04-09), LINEA (07-09), GRANDE PUNTO (07-09), DOBLO 1 CARGO (05-09), PANDA EV02 (05) FORD: KA 1.2 DURATEC (09) ALFA ROMEO
FERRAMENTAS OEM	1 860 987 000 (1), 2 000 004 400 (2), 2 000 015 800 (3), 2 000 004 300 (4), 2 000 004 500 (5)
CÓDIGOS DE MOTOR	1.2: 169A4.000 / 199A4.000 . 1.4: 350A 1.000 / 188A4.000-EV02.

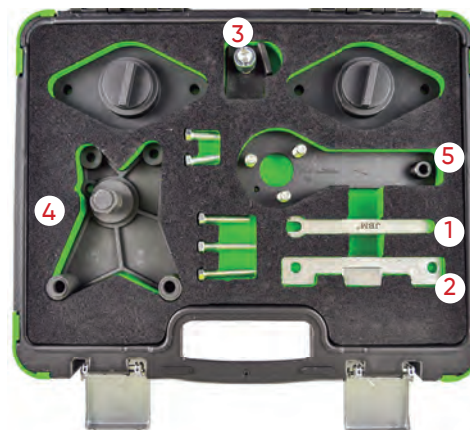

53319

18,00€

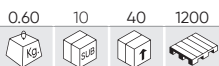

KIT DE BLOQUEIO FIAT IVECO 2.3, 3.0 JTD

MARCAS	FIAT: 2.3 / 3.0 JTD. IVECO: DAILY.
FERRAMENTAS OEM	99360614, 1860 617 000, 99360615, 2 000 018 200.
CÓDIGOS DE MOTOR	F1AE0481C, F1AE0481D, F1AE0481N, F1CE0481A/D.

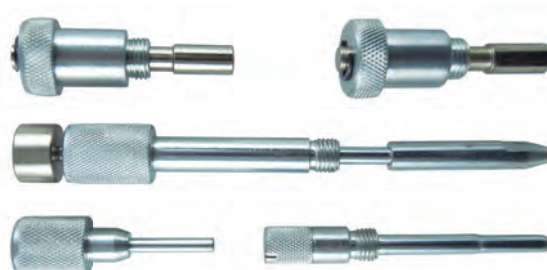

54202

68,00€



KIT DE BLOQUEIO DE DISTRIBUIÇÃO PARA FIAT/ALFA ROMEO/LANCIA

MARCAS	ALFA ROMEO: GIULIETTA (10-14), MITO (08-17). FIAT: 500 (07-19), 500L (12-19), 500C (07-19), 500 ABARTH (08-17), BRAVO (07-14), BRAVA/BRAVO (98-02), DOBLO/DOBLO CARGO (10-19), EGEA (15-20), GRANDE PUNTO (07-10), GRANDE PUNTO ABARTH (07-10), IDEA (04-12), LINEA (07-10), MAREA/WEEKEND (98-00), PALIO WEEKEND (01-06), PANDA (07-11), PUNTO (97-08), STILO (01-08), TIPO (15-20). LANCIA: DELTA (08-12), MUSA (04-13), YPSILON (96-11).
FERRAMENTAS OEM	2.000.004.500 (1), 1.860.985.000 (2), 1.860.992.000 (3), 1.860.987.000 (4), 2.000.015.800 (5)
CÓDIGOS DE MOTOR	1.2 16V:176B9.000, 182B2.000, 188A5.000. 1.4 16V / T-JET: 169A3.000, 192B2.000, 198A1.000, 198A4.000, 199A6.000, 198A8.000, , 312A1.000, 312A3.000, 843A1.000, 955A1.000.

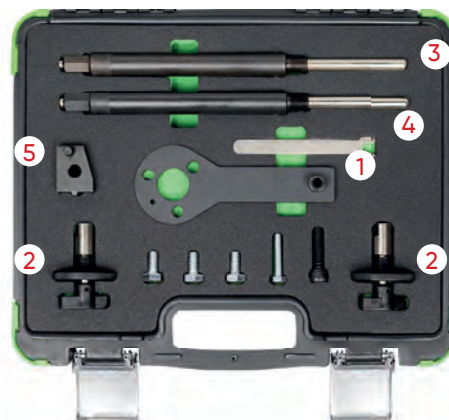

54203

91,00€

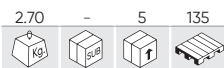

KIT DE BLOQUEIO DE DISTRIBUIÇÃO PARA ALFA ROMEO/LANCIA 1.8 TBI

MARCAS	ALFA ROMEO: 159(09-12), BRERA(09-11), GIULIETTA(10-19), SPIDER(09-11), 4C(13-19). LANCIA: DELTA(09-14).
FERRAMENTAS OEM	2 000033500 (1), 2000 003000 (2), 1860898 000 (3).
CÓDIGOS DE MOTOR	ALFA ROMEO 1,75 TBI: 939B1.000, 940A1.000, 940B2.000, 960A1.000 LANCIA 1,75 DI TURBO JET: 939B1.000

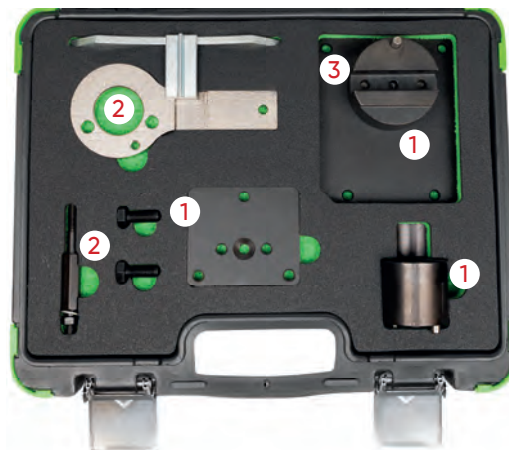

54211

74,00€

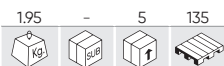

KIT DE BLOQUEIO DE DISTRIBUIÇÃO PARA FIAT/FORD/OPEL/SUZUKI 1.3L

MARCAS	FIAT: PUNTO (2003-2007) / PANDA (2003-2009) / IDEA (2004-2006) / DOBLO (2004-2006). FORD: KA. VAUXHALL / OPEL: AGILA (2003-2008) / CORSA C (2003-2007) / CORSA D (2006-2009) / COMBO C (2003-2009) / ASTRA H (2004-2009) TIGRA B (2004-2009) / MERIVA (2004-2009). SUZUKI: IGNIS (2003-2009) / WAGON R (2003-2009) / SWIFT (2003-2010).
FERRAMENTAS OEM	1871000200 / 303-1469 / KM-662-C (1), EN 46785 / KM 955 / 09912-38300 (2), 1871000900 / 1860985000 / 303-1472 / EN 46781 / 09917-68610 (3), 1870900400 (4), 1870900300 / 303-1468 (5)
CÓDIGOS DE MOTOR	FIAT: 1.3 JTD 188A9.000 / 169A.000 / 188A8.000 / 199A3.000. FORD: 1.3 TDCI. VAUXHALL / OPEL: 1.3 CDTI Z13DT / Z13DTH / Z13DTJ. SUZUKI: 1.3 CDTI Z13DT.



54212

39,40€



KIT DE BLOQUEIO DE DISTRIBUIÇÃO PARA FIAT/LANCIA 1,4 12V

MARCAS	MAREA/MAREA_WEEKEND(96-20), BRAVA(95-98), BRAVO(95-98). LANCIA: YPSILON(96-20)
FERRAMENTAS OEM	1860899000 (1), 1860901000 (2)
CÓDIGOS DE MOTOR	1.4 12V : 182A3.000, 182A5.000.



54215

57,00€

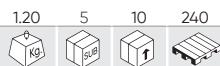

KIT DE BLOQUEIO DE DISTRIBUIÇÃO PARA ALFA ROMEO/FIAT 1.4 MULTIAIR

MARCAS	ALFA ROMEO GIULIETTA, MITO / FIAT PUNTO, PUNTO EVO 1.4 (TURBO) MULTIAIR (105/135/163/170PS)
FERRAMENTAS OEM	ALFA ROMEO / FIAT: 1860987000 (1), 2000034400 (2), 2000004500 (3)
CÓDIGOS DE MOTOR	940A2.000 / 940A2.000 / 955A8.000 / 955A8.000 / 940A2.000 / 955A8.000 / 955A2.000 / 955A7.000 / 955A6.000 / 955A8.000



54216

49,00€



KIT DE BLOQUEIO DE DISTRIBUIÇÃO PARA FIAT/OPEL/ALFA 1.9, 2.4L 16V

MARCAS	OPEL 1.9, ALFA-ROMEO 1.9-2.4 L DIESEL, FIAT 1.9- 2.4 L DIESEL
FERRAMENTAS OEM	OPEL EN-46788 / FIAT 1.860.905.000 / 1.860.905.010 (1) FIAT 1.860.898.000 (2) OPEL EN-46789 / FIAT 1.870.896.900 (3) OPEL KM 6130 / KM 6349 (4)
CÓDIGOS DE MOTOR	OPEL 1.9 CDTI Z19DT, Z19DTH, Z19DTJ ALFA-ROMEO 1.9 Y 2.4 L : 323.02, 371.01, 342.02, 325.01, 362.02, 182B9.000, 937A2.000, 937A3.000, 192A5.000, 192B1.000, 937A4.000, 937A5.000, 939A2.000, 939A1.000, 939A7.000, 939A8.000, 839A6.000, 841C.000 FIAT 1.9 Y 2.4 L : 182B4.000, 182B9.000, 185A6.000, 186A6.000, 186A8.000, 186A9.000, 188A2.000, 188A7.000, 188B2.000, 192A1.000, 192A3.000, 192A5.000, 192A8.000, 192A9.000, 192B4.000, 192B5.000, 198A2.000, 198A3.000, 198A6.000, 199A5.000, 223A7.000, 937A5.000, 939A1.000, 939A2.000, 939A3.000, 939A7.000



54430

34,00€

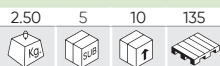

KIT DE BLOQUEIO ALFA ROMEO/FIAT/LANCIA 0.9 TWIN AIR

MARCAS	ALFA ROMEO: MITO (2001-2018) CHRYSLER: YPSILON (2011-2015) FIAT: 500/500C (2010-2020), 500L/500L LIVING/500L MPW (2012-2018), PUNTO (2012-2018), PANDA (2012-) LANCIA: YPSILON (2011-2018)
FERRAMENTAS OEM	2 000 035 100 (1) 2 000 035 200 (2) 2 000 035 300 (3)
CÓDIGOS DE MOTOR	Q.9: 199B6.000, 199B7.000, 312A2.000, 312A4.000, 312A5.000, 312A6.000, 312A7.000



53259

97,00€

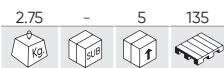

KIT DE BLOQUEIO BMW N42, N46 1.8, 2.0 CADEIA

MARCAS	BMW 1 SERIES: 118I E81/82/87/88 (04-14), 120I E81/82/87/88 (04-14). BMW 3 SERIES: 316I/TI COMPACT E46 (01-07), 318I/TI COMPACT E46 (01-07), 318I, E90/91/92/93 (05-12), 320I E90/91/92/93 (05-12). BMW 5 SERIES: 520I E60/61 (07-10), Z4 2.0 E85/86 (04-09). BMW X SERIES: X1 SDRIVE 18I E84 (10-12), X1 XDRIVE 18I E84 (10-12), X3 2.0 E83 (05-10).
FERRAMENTAS OEM	119350 (1), 119340 (2), 119291 (3), 119292 (4), 119270 (5), 115120 (6), 119190 (7), 119293 (8)
CÓDIGOS DE MOTOR	1.8: N42; B18A, N46; B18. / 2.0: N42; B20A, N46; B20, B20B, N46T; B20, B20B, B20BD, B20BZ, B20O2, B2O2.



53260

168,00€

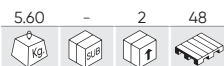

KIT DE BLOQUEIO BMW N43 1,6/2,0 CADEIA

MARCAS	BMW 1 SERIES: 116I E81/82/87/88 (07-12), 118I E81/82/87/88 (06-14), 120I E81/82/87/88 (06-14). BMW 3 SERIES: 316I E90/91/92/93 (07-11), 318I E90/91/92/93 (07-13), 320I E90/91/92/93 (07-14). BMW 5 SERIES: 520I E60/61 (07-10).
FERRAMENTAS OEM	118690 (118691/118692/118693) (1), 118710 (118711/118712) (2), 113340 (3) (4), 118700 (5), 119340 (119341/119342) (6), 115120 (7).
CÓDIGOS DE MOTOR	1.6: N43 B16A/AA, B16AA, B16AA/OO. 2.0: N43 B20A, B20A/AA, B20AA, B20AY, B20KO, B20UO.

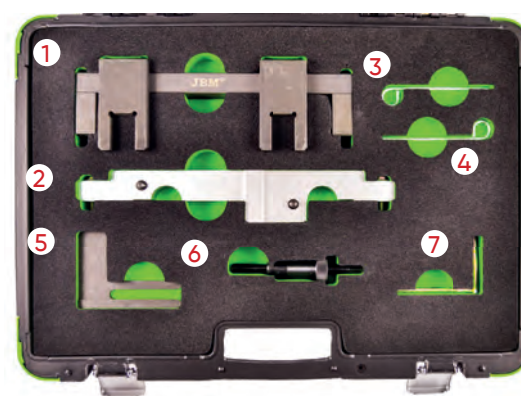

53261

214,00€

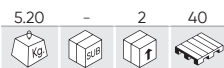

KIT DE BLOQUEIO BMW N42, N46 1.8, 2.0

MARCAS	BMW 1 SERIES: 118I E81/82/87/88 (04-14), 120I E81/82/87/88 (04-14). BMW 3 SERIES: 316I/TI COMPACT E46 (01-07), 318I/TI COMPACT E46 (01-07), 318I E90/91/92/93 (05-12), 320I E90/91/92/93 (05-14). BMW 5 SERIES: 520I E60/61 (07-10). BMW X SERIES: X1 E84 SDRIVE 18I (10-12), X1 E84 XDRIVE 18I (10-12), X3 E83 2.0 (05-10). BMW Z SERIES: Z4 2.0 E85/86 (04-09).
FERRAMENTAS OEM	119190 (1), 119310 (2), 119302 (3)
CÓDIGOS DE MOTOR	2.0: N42 B18A, N42 B20A, N46 B18, N46 B20, N46 B20B, N46T B20, N46T B20B, N46T B20BD, N46T B20BZ, N46T B20O2, N46T B2O2

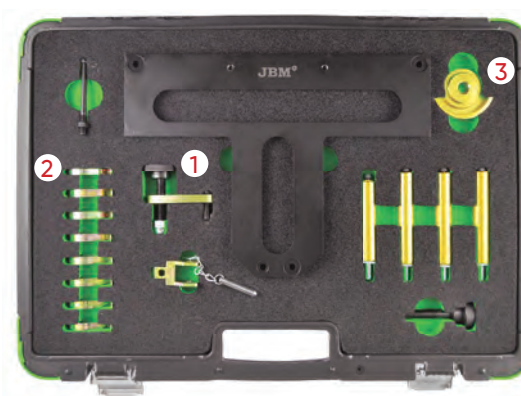

53262

251,00€

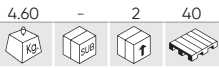

KIT DE BLOQUEIO EIXO DE COMANDO BMW M52TU, M54, M56 DUPLO VÃOS

MARCAS	<p>M52TUB25: 1997-2001 E46 323i/323Ci/323Ti (M52T); 1998-2001 E39 523i (M52TU); 1998-2001 E36/7 Z3 (M52TU). M52TUB28: 1997-2001 E46 328i/328Ci (M52TU); 1997-2001 E36/7 Z3 2.8 (M52B28/Z3); 1998-2001 E39 528i (M52TU); 1998-2001 E38 728i (M52TU). M54B22: 2001-2003 E46 320i/320Ci; 2001-2003 E39 520i; 2001-2002 E36 Z3 2.2i; 2003-2005 E85 Z4 2.2i; 2003-2005 E60/E61 520i. M54B25: 2001-2002 E36/7 Z3 2.5i; 2001-2005 E46 325i/325Xi; 2001-2006 E46 325Ci; 2001-2004 E46 325Ti; 2001-2004 E39 525i; 2003-2004 E60/E61 525i/525Xi; 2004-2006 E83 X3 2.5i; 2004-2006 E85 Z4 2.5i. M54B30: 2001-2005 E46 330i/330Xi; 2001-2006 E46 330Ci; 2001-2003 E39 530i/2001-2002 E36 Z3 3.0i; 2003-2005 BMW E60 530i; 2003-2006 E85 Z4 3.0i; 2001-2006 E53 X5 3.0i.</p>
FERRAMENTAS OEM	116150 (1), 113450 (2), 113292 (3), 116180 (4), 114220(5)



53263

57,00€

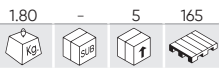

KIT BLOQUEIO EIXO DE COMANDO BMW M47 LAND ROVER TD4,TD6

MARCAS	<p>BMW 1 SERIES: 118D E87 (04-07), 120D E87 (04-07). BMW 3 SERIES: 318D/TD COMPACT E46 (01-05), 318D/TD E90/91 (05-08), 320D/TD COMPACT E46 (98-05), 320D/CD E90/91 (05-08), 325D E90/91/92/93 (02-10), 330D/CD E46/90/91/92/93 (99-07), 335D E90/91/92 (06-11). BMW 5 SERIES: 520D E39/60/61 (00-09), 525D/XD E39/60/61 (00-10), 530D/XD E46/60/61 (98-10), 535D E60/61 (04-10). BMW 6 SERIES: 635D E63/64 (07-11). BMW 7 SERIES: 730D/LD E38/65/66 (98-08). BMW X SERIES: X3 2.0D E83 (04-07), X3 3.0D/SD E83 (03-10), X5 3.0D E53/E70 (00-10), X6 3.0D E71/72 (08-10), X6 3.5D E71/72 (08-10). LAND ROVER: FREELANDER TD4 (00-06), RANGE ROVER TD6 (02-06). MG/ROVER: MG-ZT/T (01-05), ROVER 75 CDT/CDTI (99-05). VAUXHALL/OPEL: OMEGA-B (01-03).</p>
FERRAMENTAS OEM	112300/12-108, 12-171/KM-813 (1), 113340/12-172/KM-823 (2) (3), 116322/12-174/KM-6267 (4) 116320 (5)
CÓDIGOS DE MOTOR	<p>BM - 2.0D: M47, M47T2, M47TU / 2.5D: M57, M57T2, M57TU / 3.0D: M57, M57T2, M57TU LAND ROVER - 2.0D: 204D3 (TD4) / 3.0D: 306D1 (TD6) MG/ROVER- 2.0D: M47R / 2.0D CDT: M47R VAUXHALL/OPEL- 2.5D: Y25DT</p>



53264

143,00€

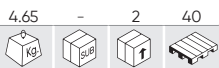

KIT DE BLOQUEIO BMW N62, N73

MARCAS	<p>BMW 5 SERIES: 540i E60/61 (05-10), 545i E60/61 (03-06), 550i E60/61 (05-10). BMW 6 SERIES: 645i E63/64 (03-06), 650i E63/64 (05-11). BMW 7 SERIES: 735i E65/66 (02-05), 740i E65/66 (05-10), 745i E65/66 (02-05), 750i E65/66 (05-08), 760i E65/66 (02-08). BMW X SERIES: X5 4.4 E53 (03-07), X5 4.8 E53/E70 (04-10).</p>
FERRAMENTAS OEM	119463 (1), 119462 (2), 119340 (3), 119461 (4), 119190 (5)
CÓDIGOS DE MOTOR	<p>3.6 V8: N62 B36A 4.4 V8: N62 B44A 4.0 V8: N62 B40A 4.8 V8: N62 B48B 6.0 V12: N73 B60A</p>

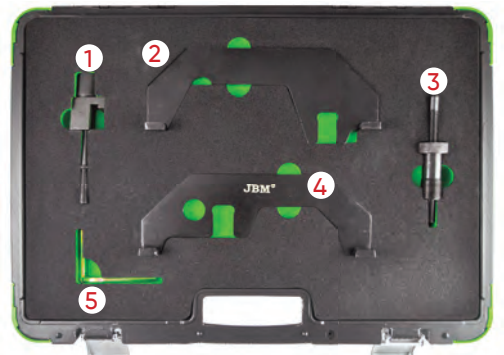

53265

195,00€

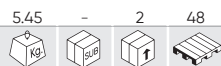

KIT DE BLOQUEIO BMW DIESEL M47, M57, M41, M51

MARCAS	BMW
FERRAMENTAS OEM	113360 (1), 116321 (2), 135190 (3), 135191 (4), 135192 (5), 116322 (6), 112300 (7), 113340 (8)
CÓDIGOS DE MOTOR	M41 / M51 / M47TU / M47TU T2. M57TU T2 3.01 1998 - 2008.

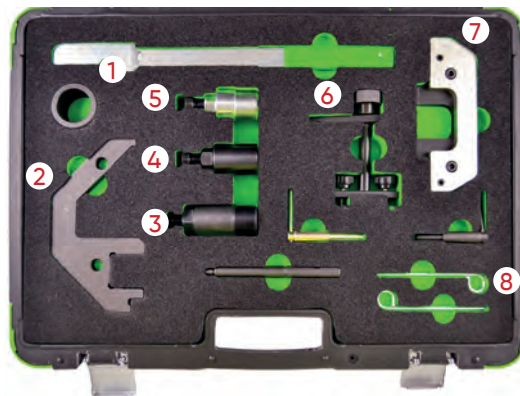

53266

224,00€



KIT DE BLOQUEIO BMW M42, M43, M50, M51, M52

MARCAS	BMW
FERRAMENTAS OEM	113240 (1), 115490 (2), 113190 (3), 112300 (4) (5), 113292 (6), 113320 (7)
CÓDIGOS DE MOTOR	PETROL: M42, M43, M50, M52, M60. DIESEL: M51

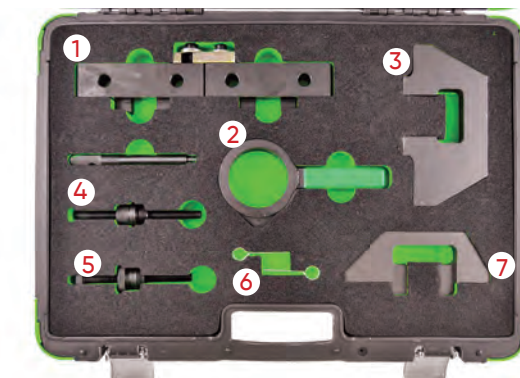

53267

277,00€



KIT DE BLOQUEIO BMW BMW M40, M43, M42, M44, M52, M54, M56

MARCAS	BMW SERIES: 3, 5, 7, X, Z
FERRAMENTAS OEM	114220 (1), 112300 (2), 113240 (3), 115490 (4), 113292 (5), 113450 (6)
CÓDIGOS DE MOTOR	M40. M44. M50. M52. M54. M56.

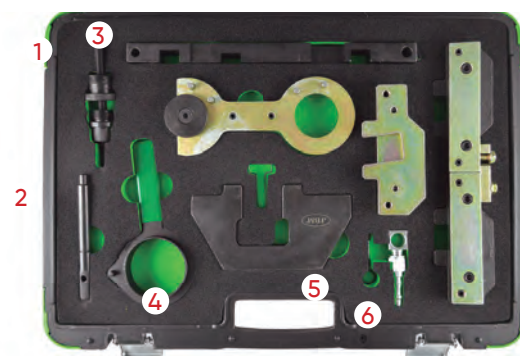

53269

50,00€

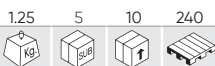

KIT DE BLOQUEIO BMW N47, N47S, N57

MARCAS	<p>BMW 1 SERIES: 116D E81/82/87/88 (08-12), 118D E81/82/87/88 (07-14), 120D E81/82/87/88 (07-14), 123D E81/82/87/88 (07-14). BMW 2 SERIES: 218D (11-14), 220D (11-14), 225D (11-14). BMW 3 SERIES: 316D E90/91/92/93 (09-12), 318D E90/91/92/93 (07-12), 320D E90/91/92/93 (07-12), 325D E90/91/92/93 (10-14), 330D/XD E90/91/92/93 (08-14). BMW 5 SERIES: 520D E60/61 (07-10), 525D F10/11 (10-12), 530D F10/11 (10-13), 530DGT F07 (09-12), 535D F10/11 (10-17), 535DGT F07 (10-12). BMW 7 SERIES: 730D/LD F01/02/04 (08-12), 740D F01/02/04 (09-12), 740D XDRIVE F01/02/04 (09-12), 750D XDRIVE F01/02/04 (12-15). BMW X SERIES: X1 SDRIVE 18D E84 (09-15), X1 SDRIVE 20D E84 (09-12), X1 XDRIVE 18D E84 (09-15), X1 XDRIVE 20D E84 (09-15), X1 XDRIVE 23D E84 (09-12), X3 2.0D E83 (07-10), X3 XDRIVE 18D E83 (08-10), X3 XDRIVE 30D E83 (11-12), X3 XDRIVE35D F25 (11-17), X5 3.0D E70 (10-13), X5 XDRIVE 40D X5 F15 M50D (13-17), E70 (10-13), X6 XDRIVE 30D E71/72 (10-14), X6 XDRIVE 40D E71/72 (10-14), X6 F16 M50D (14-17). BMW MINI: PACEMAN (13-17), COUNTRYMAN (10-17), MINI (10-15), ROADSTER (12-14), CLUBMAN (10-14), CLUBVAN (12-14).</p>
FERRAMENTAS OEM	118760 (1), 118740 (2), 116480 (3), 115320 (4)
CÓDIGOS DE MOTOR	<p>1.6 D: N47; C16K1, C16U1. 2.0 D: N47; C20K1, C20U1N47; D20, D20A, D20B, D20D, D20K1, D20O0, D20O1, D20T1, D20U0, D20U1, N47S D20T0, N47T; D20, D20O1, D20U1. 3.0 D: N57; B30B, B30B/T0, B30C, D30BT0, D30O0, D30O1, D30T0, D30T1, D30U0.</p>



54206

113,00€



KIT DE BLOQUEIO DE DISTRIBUIÇÃO PARA BMW/MINI 1.5 , 2.0L

MARCAS	<p>BMW - 1 SERIES - 114D, 116D, 214D - (F20/ 21) - (2015- 2017) - 2 SERIES - 216D, 118D, 125D - (F22/ 23/ 45/ 46) - (2014-2017) - 3 SERIES - 218D, 220D, 225D - (F30/31/34) - (2015-2017) - 4 SERIES - 316D/320D/325D - (F32, 33, 36) - (2015-2017) - 5 SERIES - 420D, 425D, 418D - (F10, 11) - (2014-2017) - X1 SERIES - 518D - (F48) - (2015-2017) - X3 SERIES - (F25) - (2014-2017) - EFFICIENT DYNAMICS - X4 SERIES - (F26) - (2014-2017) - XDRIVE - X5 SERIES - (F15) - (2015-2017) - SDRIVE MINI - CLUBMAN - (F54) - (2015-2017) - ONE D CONVERTIBLE - (F57) - (2016-2017) - COOPER D/ SD MINI HATCH (F55, 56) - (2014-2017)</p>
FERRAMENTAS OEM	114120 (1), 2347904 (2), 2365488 (3), 2288380 (4), 118760 (5), 118740, 118030 (6)
CÓDIGOS DE MOTOR	<p>1.5: B37 D15A, B37 C15A 2.0: B47 D20A, B47 D20B, B47 C20A, B47, B47 C20B</p>

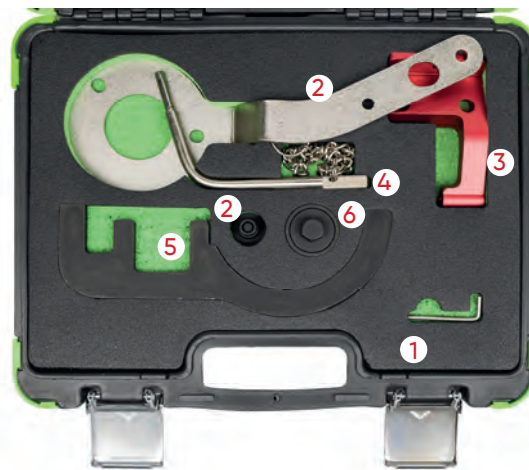

SEU CONJUNTO DE FERRAMENTAS DE CRONOMETRAGEM AINDA MAIS PRÓXIMO

INSIRA O CÓDIGO DA FERRAMENTA OEM OU O CÓDIGO DO MOTOR DO SEU CARRO EM SEU NAVEGADOR DA INTERNET E ENCONTRE UMA FERRAMENTA DE CRONOMETRAGEM COMPATÍVEL

54219

60,00€



KIT DE BLOQUEIO DE DISTRIBUIÇÃO PARA BMW/MINI/CITROËN/PEUGEOT

MARCAS	BMW MINI PSA
FERRAMENTAS OEM	115140 (1), 119280 (2), 119330 (3), 113340 (4), 114360 (5)
CÓDIGOS DE MOTOR	BMW 1.6 (N40 / N45 / N45T, B16, B16A, B16AC) 1.8 / 2.0 (N42 / N46 / N46T) 2.0 / 3.0 (N51 / N52 / N52-COMPONENTE / N53 / N54) PSA 1.4 / 1.6 16V (EP3 / EP6 / EP6DT / EP6DTS) MINI 1.4 / 1.6 (N12 / N14)



54222

59,00€



KIT DE DISTRIBUIÇÃO PARA MINI 1.6

MARCAS	BMW: MINI COOPER S(07-10) PEUGEOT: 207(06-10), 307(06-10), GT(06-10), THP(06-10), GTI(06-10) CITROËN: DS3(06-10), C4(06-10), GRANDE PICASSO TPH(06-10)
FERRAMENTAS OEM	119550(1), 119551(2), 119552(3), 119590(4)
CÓDIGOS DE MOTOR	N14 B16A , N14 B16CD , N14 B16TO

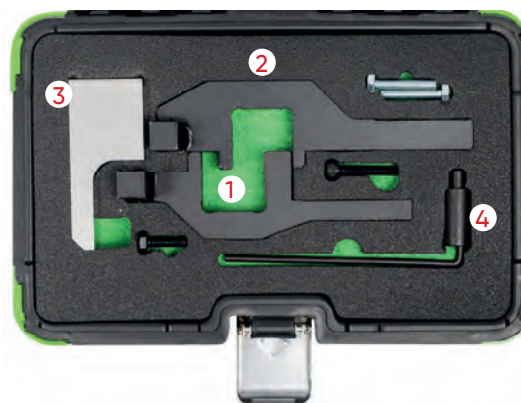

54227

122,00€



KIT DE DISTRIBUIÇÃO PARA BMW/MINI N13, N18, PSA

FERRAMENTAS OEM	EN-52127-2, EN-52588, E1 100, G 1376A, T10550/2, T10550/3, 0 496 709, 0109 2B, 0197 A11, 0197 A3, 0197 A31, 0197-A1, 0197-A1Z, 0197-A11, 0197A2, 0197-A31, 0197-A32, 0197-A33, 0197-BZ, 0197-M, 0197-N, 11 7 440 (1), 11 9 340 (2), 11 9 540, 11 9 551, 11 9 590, 1376-A, 2 299 362 (3)
CÓDIGOS DE MOTOR	N12 B14A, N13 B16A, N14 B16A, N14 B16C, N16 B16A, N18 B16A, N18 B16C, 5FA (EP6CDT), 5FD (EP6DTS), 5FE (EP6CDT), 5FE (EP6CDTM), 5FF (EP6DTS), 5FG (EP6CDTR), 5FH (EP6C), 5FK (EP6C), 5FK (EP6CB), 5FL (EP6C), 5FM (EP6CDTM), 5FN (EP6CDT), 5FP (EP6), 5FR (EP6DTE), 5FS (EP6C), 5FT (EP6DT), 5FU (EP6CDTX), 5FV (EP6CDT), 5FW (EP6), 5FX (EP6DT), 5FY (EP6DTS), 5GF (EP6FADTX), 5GF (EP6FADTXD), 5GG (EP6FADTX), 5GM (EP6FDTX), 5GN (EP6FDTR), 5GP (EP6FDTR), 5GR (EP6FDTX), 5GT (EP6FDTX), 5GW (EP6FDT), 5GY (EP6FADTXD), 5GY (EP6FDT), 5GY (EP6FDTM), 5GZ (EP6FDT), 8FN (EP3C), 8FP (EP3C), 8FR (EP3C), 8FS (EP3)



54228

187,00€



KIT DE BLOQUEIO DE DISTRIBUIÇÃO PARA BMW/MINI 1.2, 1.5, 2.0, 3.0

MARCAS	BMW: 1 SERIES (2015 - 2019), 2 SERIES (DESDE 2014), 3 SERIES (DESDE 2015), 4 SERIES (DESDE 2015), 5 SERIES (DESDE 2017), 6 SERIES (DESDE 2017), 7 SERIES (DESDE 2015), i8 (DESDE 2014), X1 (DESDE 2015), X2 (DESDE 2018), X3 (DESDE 2017), X4 (DESDE 2018) AND Z4 (DESDE 2019); MINI: CLUBMAN (DESDE 2015), HATCH (DESDE 2014), CONVERTIBLE (DESDE 2016) AND COUNTRYMAN (DESDE 2017)
FERRAMENTAS OEM	2 358 122 (1), 2 357 904 (2), 2 365 488 (3), 2 288 380 (4), 11 4 120 (5).
CÓDIGOS DE MOTOR	BMW: 1,5 B38 A15A, B38 B15A, B38 K15A ,1,6 B48 B16A, 2,0 B48 A20A, B48 A20B, B48 A20E, B48 B20A, B48 B20B , 3,0 B58 B30A, B58 B30B, B58 B30C MINI: 1,2 B38 A12A , 1,5 B36 A15A, B38 A15A , 2,0 B46 B20A, B48 A20A, B48 A20B

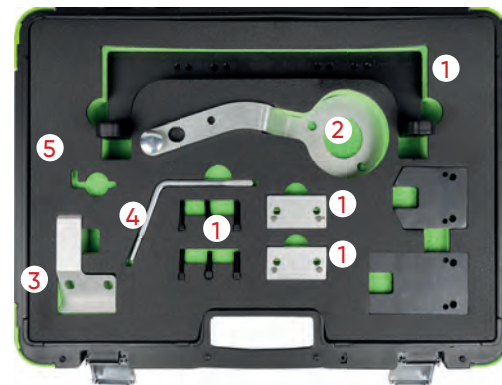

54293

17,50€



CONTRA-MANCAL DA CAMBOTA PARA BMW

MARCAS	BMW 1 SERIES E81/82/87/88: 116D (2008-2012),118D (2007-2012),120D (2007-2014), 123D (2007-2014) BMW 1 SERIES E22: 218D (2011-2014), 220D (2011-2014), 225D (2011-2014) BMW 3 SERIES E90/91/92/93: 316D (2007-2012), 318D (2007-2014),320D (2007-2012), 325D (2010-2012), 330D (2008-2014) BMW 5 SERIES E60/61: 520D (2007-2010) BMW 5 SERIES F10/11: 525D (2010-2013), 530D (2010-2013),530D XDRIVE (2011-2015), 535D (2010-2013), 535D XDRIVE (2011-2015),M550D XDRIVE (2012-2015) BMW 5 SERIES E07: 535D GT (2009-2015) BMW 7 SERIES F01/02/04: 730D (2008-2012), 740D (2009-2012),750D XDRIVE (2012-2015) BMW X1 E84: 18D SDRIVE (2009-2015), 20D SDRIVE (2009-2015), 18D XDRIVE (2009-2015), 20D XDRIVE (2009-2015), 23D XDRIVE (2009-2012) BMW X3 E83: 2.0D (2007-2008), 18D XDRIVE (2008-2010) BMW X5 E70: 3.0D XDRIVE (2010-2013), 40D (2010-2013) BMW X6 E71/71: 30D XDRIVE (2010-2014), 40D XDRIVE (2010-2014)
FERRAMENTAS OEM	T10016
CÓDIGOS DE MOTOR	2,0: N47D20C, N47D20D 2,0D: N47, D20A, D20A/KO, D20B, D20B/TO, D20C,D20O0, D20O1, D20U0, D20U1 D20K1 3,0D: N57, D30U0, D30O0, D30O1, D30T0, D20T0,D30A, D30A/O0, D30B , D30B/T1, D30C, D30C/S1,D30A0/O0, D30A0/O1



54398

41,00€



JOGO DE BLOQUEIO DE VOLANTE / POLIA DA CAMBOTA PARA BMW/MINI

MARCAS	MINI HATCH (14-21), CABRIOLET (16-19), CLUBMAN (15-19), COUNTRYMAN (17-19)
FERRAMENTAS OEM	11 6 480 (1) 11 9265 (2) 11 4 180 (3) 11 9 810 (4) 11 9 811 (4)
CÓDIGOS DE MOTOR	BMW: 116i (15-19), 116d (15-19), 118d (15-19), 120d (15-19), 125d (15-19), M140i (16-19), 214d (15-19), 216i (18-19), 216d (14-20), 218d (17-19), 218i (15-21), 220d, (14-20), 225d (15-20), M240i (16-19), 316d (15-19), 318i (15-19), 320d (15-19), X1 (15-20),X2 (18-19), X3 (14-18), X4 (17-20), X5 (15-18), i8 (14-18) 325d (16-20),330i (15-20), 340i (15-19), 418i (15-20), 420d (15-20), 425d (16-18), 430i (16-20),440i (16-19), 518d (14-17), 525d (17-20), 530i (17-18), 540i (17-19), 620d (18-20), 630i (17-19), 640i (17-19), 725d (16-19), 730i, (15-19), 740i (15-19)



54399

56,50€

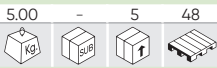

N

KIT DE BLOQUEIO BMW/ROVER/OPEL 2.5D

MARCAS	BMW: 318TDS (94-00), 325TD (91-99), 325TDS (91-99), 525TD (90-03), 525TDS (90-03), 725TDS (95-02) RANGE ROVER: P38 (94-02) VAUXHALL/OPEL: OMEGA-B (94-01)
FERRAMENTAS OEM	KM811 (1), 113320 (1), 12112 (1) KM822 (2), 113360 (2), 12115 (2) KM813 (3), 115120 (3), 112300 (3), 12108 (3) KM823 (4), 113340 (4), 12172 (4)
CÓDIGOS DE MOTOR	256T, 25DT, M41/174T1, M51/256T1, M51/256T1L, X25DT



54400

141,00€

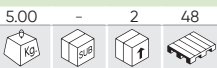

N

KIT DE BLOQUEIO BMW N20, N26

MARCAS	BMW: 1 SERIES 125I - F20/21 (2012-2016) 2 SERIES COUPE 220I, 228I - F22 (2014-2016) 2 SERIES CABRIOLET 220I 228I - F23 (2015-2016) 3 SERIES 320I 328I XDRIVE - F30/31 (2012-2015) 3 SERIES GRAN TURISMO 320I, 328I/XDRIVE - F34 (2013-2016) X4 XDRIVE 20I, 28I (F26) 2014 - 2018, X5 XDRIVE40E (F15) 2015 - 2018, Z4 SDRIVE18I, 20I, 28I (E89) 2011 - 2017 4 SERIES COUPE 420I, 428I/XDRIVE - F32(2013-2016), 4 SERIES CABRIOLET 420I, 428I/XDRIVE-F33 (2014-2016) 4 SERIES GRAN COUPE 420I, 428I/XDRIVE F36 (2014-2016) 5 SERIES 520I, 528I/XDRIVE(F10/11) 2010 - 2017, 5 SERIES GRAN TURISMO 528I-(F07) 2013 - 2016, X1 SDRIVE16I, 18I, 20I, XDRIVE20I, 28I-(E84) 2011 - 2015, X3 SDRIVE18I, 20I, XDRIVE20I, 28I (F25) 2011 - 2017
FERRAMENTAS OEM	11 9 340/341 (1), 11 9 340A (1), 11 9 341 (1), 119340 (1) 2 212 830 (2) 2 212 831 (3) 2 219 548 (4)
CÓDIGOS DE MOTOR	1,6 N20 B16A 2,0 N20 B20 N20 B20A N20 B20A N20 B20B N20 N20B/UO N20 B2000 N20 B2000 N26 B20 B26 B20A

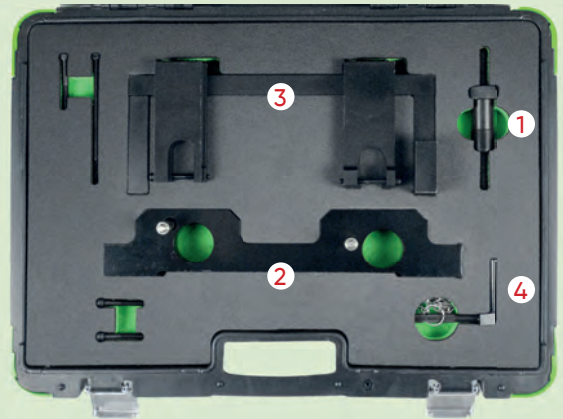

54401

57,00€



N

KIT DE BLOQUEIO BMW/MINI N13, N18

MARCAS	BMW 114I (2012-2015) BMW 116I (2012-2015) BMW 118I (2011-2015) BMW 316I (2012-2015) MINI CLUBMAN (R55) (2011-2014) MINI COOPER S (R56/57) (2010-2015) MINI COUNTRYMAN (R60) (2012-2016) MINI COUPE COOPER S (R58) (2012-2015) MINI PACEMAN (R61) (2013-2017) MINI ROADSTER (R59) (2012-2015)
FERRAMENTAS OEM	11 7 440 (1), 117440 (2), 11 9 340 (3), 11 9 590 (4), 49 6 709 (5)
CÓDIGOS DE MOTOR	N13 B16A N18 B16A N18 B16/MO N18B16A/MO N18B16C N18B16C/TO N18B16MO

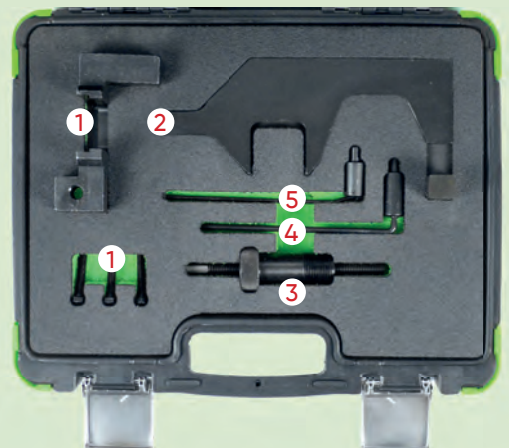

54402

201,00€



N

KIT DE BLOQUEIO BMW N51, N52, N53, N54, N55

MARCAS	E60: 523i, 523Li, 525i, 525Li, 525Xi, 528i, 528Xi, 530i, 530Li, 530Xi, 535i, 535Xi E61/E63: 523i, 525i, 525Xi, 530i, 530Xi, 535Xi, 630i E64/E65: 630i, 730i E66/E70: 730Li, X5 3.0Si E81/E82: 130i, 135iS E83: X3 2.5i, 2.5Si, 3.0i, 3.0Si E85/E86: Z4 2.5i, 2.5Si, 3.0i, 3.0Si, Z4 3.0Si E87/E90: 130i, 323i, 325i, 325Xi, 328i, 328Xi, 330i, 330Xi, 335i, 335Xi E91: 323i, 325i, 325Xi, 328i, 328Xi, 330i, 330Xi, 335i, 335Xi E92: 323i, 325i, 325Xi, 328i, 328Xi, 330i, 330Xi, 335i E93: 325i, 328i, 330i, 335i
FERRAMENTAS OEM	110300 (1) 114280 (2) 114285 (3) 114290 (4) 114390 (5) 118520 (6) 119190 (7) 119340 (8)
CÓDIGOS DE MOTOR	N51/N52/N53/N54/N55

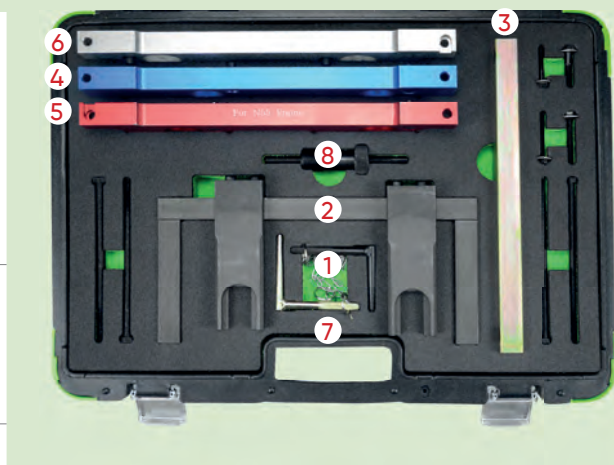

54403

225,00€



N

KIT DE BLOQUEIO BMW M60

MARCAS	BMW 5 SERIES: 530i, 540i (E34) (1992 – 1996), 535i, 540i (E39) (1996 – 2003) BMW 7 SERIES: 730i, 735i, 740i (E38) (1994 – 2002), 730i, 740i (E32) (1992 – 1994) BMW 8 SERIES: 840i (E31) (1993 – 1999) LAND ROVER/RANGE ROVER: (L322) (2002 – 2005) X5: 4.4, 4.6 (E53) (1999 – 2004)
FERRAMENTAS OEM	11 2 445 (1), 11 2 441/445 (1), LRT -12 223/2 (1) 11 2 441 (2), 12 223/1 (2), LRT 12-223/1 (2) 11 2 442 (3), 11 2 442/446 (3), 12 223/3 (3), LRT 12 223/3 (3) 11 2 446 (4), 12 223/4 (4), LRT 12 223/4 (4), LRT 12 224 (4) 11 3 390 (5), 113390/117380 (5), 12 222 (5), LRT 12 222 (5) 11 5 180 (6), 12 227 (6), LRT 12 227 (6) 11 2 300 (7), 11 5 120 (7), 12 108 (7), 12 171 (7), KM 813 (7), LRT 12 108 (7), LRT 12 171 (7) 11 6 420 (8), 12 226 (8), LRT 12 226 (8) 11 6 452 (9), 12 228/1 (9), LRT 12 228/1 (9) 11 6 451 (10), 12 228/2 (10), LRT 12 228/2 (10) 11 3 310 (11), 12 220 (11), LRT 12 220 (11) 11 6 440 (12), 12 224 (12), LRT 12 2214 (12) 11 7 380 (13), 12 221 (13), LRT 12 221 (13)
CÓDIGOS DE MOTOR	BMW 3.0: 30 8S 1 BMW 3.5: 35 8S 1, 35 8S 2 BMW 4.0: 40 8S 1 BMW 4.4: 44 8S 1, 44 8S 2 BMW 4.6: 46 8S 1 RANGE ROVER: V8/44 8S 2



54404

131,00€



N

KIT DE BLOQUEIO BMW N62, N73

MARCAS	SERIES 5, SERIES 6, SERIES 7, X5
FERRAMENTAS OEM	119461 (1), 119462 (2), 119463 (3), 119190 (4), 119340 (5), 119451 (6), 119452 (7), 119453 (8), 119454 (9), 113460 (10), B117207 (11)
CÓDIGOS DE MOTOR	N62 B36A, N62 B40A, N62 B44A, N62 B48A, N62 B48B, N73 B60A

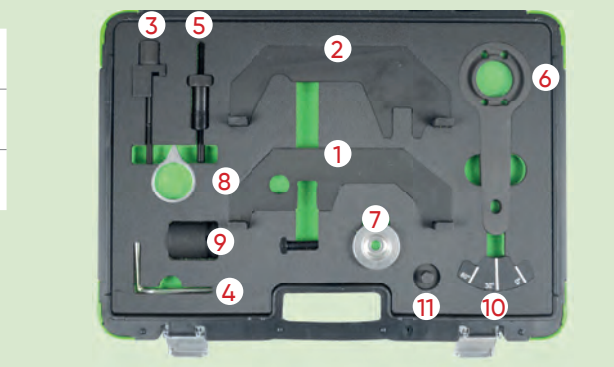

54405

111,00€



N

KIT DE BLOQUEIO BMW N63, N74

MARCAS	SERIES 5, SERIES 6, SERIES 7, X5, X6
FERRAMENTAS OEM	11 9 891 (1) 11 9 892 (1) 11 9 893 (2) 11 9 190 (3) 11 8 090 (4)
CÓDIGOS DE MOTOR	N63, N74

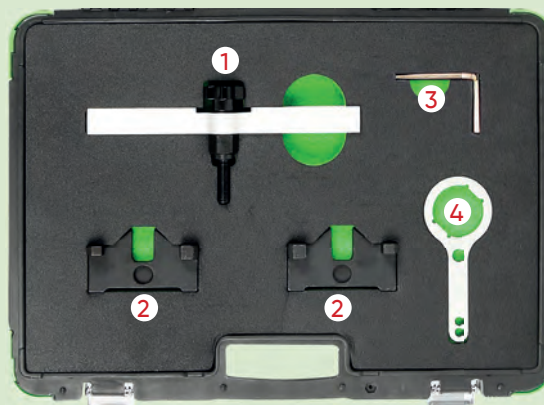

54406

73,00€



N

BLOQUEADOR DO VOLANTE DO MOTOR BMW/MINI

MARCAS	<p>BMW 1 SERIES: F20/21 (12-15), 116i (04-12), 118i (04-14), 120i (04-14), 130i (05-07), 135i (07-11), 116D (08-12), 118D (04-14), 120D (04-14), 123D (07-14), M COUPE (11-12)</p> <p>BMW 3 SERIES: F30/31 (12-15), 316Ti (04-14), 316i (04-11), 316D (09-12), 318i (04-07), 318Ti/COMPACT (04-04)</p> <p>BMW 3 SERIES: 318D (03-12), 318TD (03-07), 320D (01-07), 320D COMPACT (01-05), 318i (05-13), 320D (07-14), 320i (05-14), (05-14), 320Si(05-06)</p> <p>BMW 3 SERIES: 323i (05-11), 325i (05-14), 325D (06-10), 330D (05-08), 330i (06-13), 335D (05-13), 335i (05-11)</p> <p>BMW 4 SERIES: 420i F32 (13-15), 428i F32 (13-15), 420i F33 CABRIOLET (14-15), 428i F33 CABRIOLET (14-15), 420i F36 (14-15), 428i F36 GRAN COUPE (14-15)</p> <p>BMW 5 SERIES: F10/11 (10-15), 520D (05-10), 520i (07-10) 523i (03-10), 525D (05-10), 525i (05-10), 525i (07-10), 530D (03-10), 530i (05-10), 535D (04-10)</p> <p>BMW 6 SERIES: 630i (04-11), 635D (07-11)</p> <p>BMW 7 SERIES: 730D (05-08), 730i (02-08) BMW X SERIES: X1 E84 (09-15), X3 E83 (03-14), X5 E53 (03-14), X3 F25 (11-15), X6 E71/72 (08-10)</p> <p>BMW Z SERIES: Z4 E85/86 (04-09), Z4 (E89) (11-15)</p> <p>MINI: MINI (03-06)</p>
FERRAMENTAS OEM	11 8 180 (1), 11 8 181 (2), 11 8 182 (3), 11 8 183 (4), 11 8 184 (5), 11 8 185 (6)
CÓDIGOS DE MOTOR	BMW: M47T2, M57T2, M67, N43, N45, N45T, N46, N46T, N47, N51, N52, N53, N54 MINI: W17 DIESEL



54324

11,00€



N

INDICADOR DE DESGASTE DA CORRENTE DE DISTRIBUIÇÃO MINI

MARCAS	MINI: CLUBMAN (2007-2014), CLUBVAN (2012-2014), COUNTRYMAN (2010-2017), COUPÉ (2011-2015), MINI (2006-2015), PACEMAN (2013-2017), ROADSTAR (2012-2015)
FERRAMENTAS OEM	2353281 (1)
CÓDIGOS DE MOTOR	1,4: N12 B14AB, N12 B14 1,6: N12 B16A, N16 B16A, N16 B16M0, N16 B16U0, N16 B16A/MO, N16 B16KO, N16 B16A/MO, N18 B16A, N18 B16A/MO, N18 B16C, N18 B16A/MO, N18, N18 B16M0, N18 B16C/T0



53268

92,00€

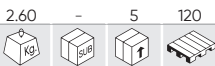

KIT DE BLOQUEIO BMW/MINI/PSA 1.4, 1.6

MARCAS	BMW/MINI: MINI CLUBVAN R55 (12-14), MINI CLUBMAN R55 (08-14), MINI COUNTRYMAN R55 (07-10), MINI CLUBMAN R56/R57 (07-15), MINI R56/R57 (08-15), MINI COUPE R58 (11-15), MINI ROADSTER R59 (08-15), MINI CLUBMAN R60 (10-14), MINI CLUBVAN R60 (12-14), MINI ROADSTER R61 (13-15), MINI PACEMAN R61 (14-15), MINI COUNTRYMAN R60 (10-17). CITROËN: C4 (08-11), C4 PICASSO (08-13) C4 GRAND PICASSO (13-15). PEUGEOT: 207 (06-14), 207CC (07-15), 308 (07-15), 3008 (09-15), 5008 (09-15).
FERRAMENTAS OEM	BMW/MINI: 115590 (1), 119340 (2), 119551 (3) CITROËN: 0197-A1, 0197-A3, 0197-B. PEUGEOT: 0197-A1, 0197-A3, 0197-BZ.
CÓDIGOS DE MOTOR	1.4: N12B14, N14B14AB. 1.6: EP3(8FS), EP3C(8FR), EP6(5FW), EP6C(5FS), EP6CDT(5FV), EP6DT(5FT), EP6DT(5FX), EP6DTS(5FY), N14B16A, N14B16CD, N14B16TO, N14B16CD/TO, N16B16A, N16B16KO, N16B16A/MO, N16B16A/MO, N16B16MO, N16B16UO.



53313

139,00€



KIT DE BLOQUEIO CITROEN/PEUGEOT

MARCAS	CITROËN: AX, BX, BOXER, BERLINGO, C25, DISPATCH, EVASION, J5, JUMPY, JUMPER, RELAY, SAXO, SYNERGIE, VISA, XM, XSARA, XANTIA, XZ, ZX. PEUGEOT: 106, 205, 206, 305, 306, 307, 309, 405, 406, 605, 607, 806, EXPERT, PARTNER, SOLARA, TALBOT.
FERRAMENTAS OEM	7099TM (1), 0188X (2), 0188P (3), 0189AZ (4), 0188H (5), 0132AJ1 (6), 0189A (7), 0188PM (8), 21-260 (9), 4527-TS1 (10), M8X70 (11), 0188K (12), 0188J (13), 0132Q (14), 4507-TL (15), 4507-TJ (16), 9044-T (17), 4507-TJ (18), 5711-TA (19), 7014-TJ (20), 7017-TR (21), 0188X (22), 7017-TW (23), 7014-TM (24), 0189L (25)

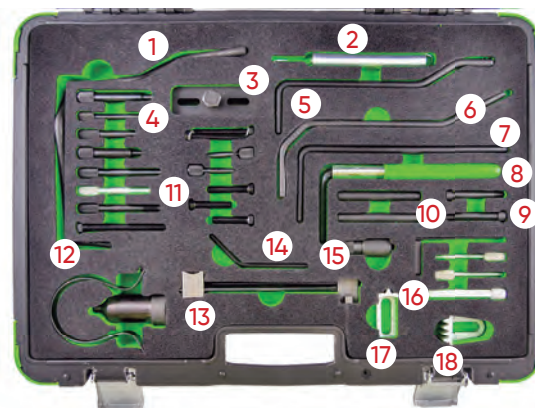

53314

98,00€

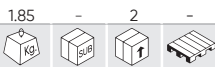

KIT DE BLOQUEIO CITROEN/PEUGEOT 1.8, 2.0

MARCAS	CITROËN: C4 PICASSO/GRAND PICASSO (06-10). C5 II (04-08), C8 (05-10), DISPATCH/JUMPY (07-11), XSARA 2.0 16V, C5 1.8/2.0/HPI, XSARA PICASSO 1.8/2.0 16V (02-05). PEUGEOT: 406 1.8 16V (00-04), 407 (06-10), 807 2.0 16V (02-05).
FERRAMENTAS OEM	0189S2 (1), 0188J (2), 0188J2 (2), 0189S1 (3), 21-260 (4), 0189B (5), 0188M (6), 0188AH (7), 0189R (8)
CÓDIGOS DE MOTOR	1.8 16V: EW7A(6FY). 2.0 16V: EW10A(RFJ), EW10ABE4(RFH), EW10J4S (RFK).

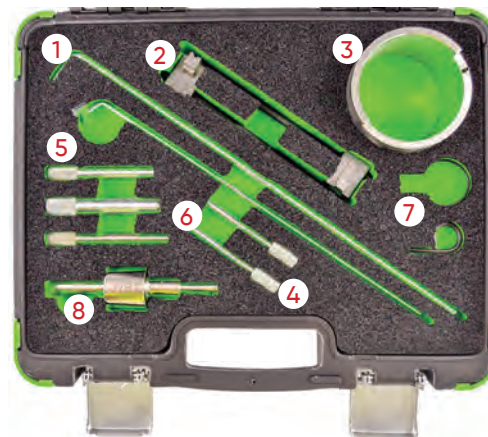

53876

64,00€

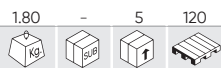

KIT DE BLOQUEIO CITROËN/PEUGEOT 1.0, 1.2 VTI

MARCAS	CITROËN: C3 (III) PEUGEOT: 208, 308, 2008 SUV (2012-2014)
FERRAMENTAS OEM	0109-2A (1) 0109-2B (2)
CÓDIGOS DE MOTOR	1.0/1.2 VTI. EBO, (ZMZ), EB2, (HMZ)



54288

72,50€



N

KIT DE BLOQUEIO PSA 1.2 GDI PURETECH

MARCAS	CITROËN: BERLINGO IV (18-20), C1 II (14-18), C3 III (12-17), C3 IV (16-18), C4 CACTUS (14-20), C4 AIRCROSS (18-20), C-ELYSEE (12-18), DS3 (12-18) PEUGEOT: 108 (14-18), 208 (12-21), 2008 (13-21), 301 (12-20), 308 (13-21), 3008 (16-21), 508 (19-21), 5008 (14-21), PARTNER III (15-18) PARTNER IV (18-21) RIFTER (19-21) TOYOTA: AYGO (14-18) GM: CROSSLAND X (17-20), COMBO E (18-20), GRANDLAND X (17-20)
FERRAMENTAS OEM	CITROËN: G-0109-6 (2), 0109-2B (1), 0109-2C (3), 0109-2D (4), 0197-N (1) PEUGEOT: G-0109-6 (2), 0109-2B (1), 0109-2C (1), 0109-2D (4), 0197-N (1) VAUXHALL: EN-52127-2 (1), EN-52809 (2)
CÓDIGOS DE MOTOR	1.2 VTI: 1PP(HM01), EB2 (HMZ), EB2DTS(HNY), EB2 (HMW), EB2M (HMY), EB2 (HMZ), EB-2DTS(HNY), HMP (EB2FB), HMT(EB2D), HMU(EB2D),HMV (EB2M), HMY (EB2M), HMZ (EB2), HMZ (EB2D), HMZ (EB2F),HMZ (EB2FB) 1.2 E-VTI: HMZ (EB2F), EB2F (HMZ) 1.2 PURETECH THP: HNZ (EB2DT) 1.2 PURETECH VTI: EB2ADS (HNS), EB2D(HMT), EB2ADJ (HNP),EB2ADT (HNK), EB2ADTX (HNN), EB2DTS (HNW), EB2DTM (HNV),EB2DTSM (HNW), EB2FA (HMR), EB2FAD (HMH), EB-2FAD (HMM),EB2DT (HNZ), EB2F (HMX), EB2F (HMT), EB2F(HMZ), EB2DTS(HNY),EB2M(HMY)

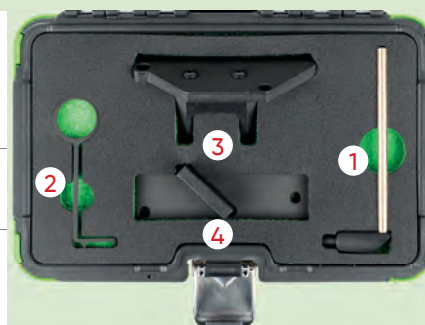

REF. DESCRIÇÃO

16400 CALIBRAGEM DE VERIFICAÇÃO DA CORREIA DENTADA PSA (REF.54288)

0.03 10 500 6,50€

54323

119,00€



N

KIT DE BLOQUEIO PSA 1.0, 1.2 VTI, 1.2 GDI PURETECH

MARCAS	CITROËN: C1 II (2014-2018), C3 III (2012-2017), C3 IV (2016-2018), C4 CACTUS (2014-2020), C4 AIRCROSS (2018-2020), C-ELYSEE (2012-2018), DS3 (2012-2018), BERLINGO IV (2018-2020), GM: CROSSLAND X (2017-2020), COMBO E (2018-2020), GRANDLAND X (2017-2020) PEUGEOT: 108 (2014-2018), 208 (2012-2021), 2008 (2013-2021), 301 (2012-2020), 308 (2013-2021), 3008 (2016-2021), 508 (2019-2021), 5008 (2014-2021), PARTNER III (2015-2018), PARTNER IV (2018-2021), RIFTER (2019-2021) TOYOTA: AYGO (2014-2018).
FERRAMENTAS OEM	EN-52127-2 (1), 0109-2B (1) J-0109-2C (2) J-0109-2D (3) EN-52127-1 (4), 0109-2A21 (4) G-0109-6 (5)
CÓDIGOS DE MOTOR	B12XHL (EB2DT), B12XHT (EB2DTS), D12XHL (EB2ADT), D12XHL (HNP/EB2ADT), D12X-HT (EB2ADTS), EBO (ZMZ), EBOF (ZMZ), EB2ADT (HNK), EB2ADT (HNP), EB2ADTD (HNK), EB2ADTS (HNS), EB2ADTX (HNN), EB2DT (HNZ), EB2DTM (HNV), EB2DTS (HNW), EB2DTS (HNY), EB2DTSM (HNW), EB2FA, EB2FAD, F12XHT (EB2ADTS), F12XHT (HNS/EB2ADTS), HMM (EB2FAD), HMM (EB2FAD), HMP (EB2FB), HMR (EB2FA), HMT (EB2), HMT (EB2F), HMU (EB2D), HMU (EB2FD), HMV (EB2M), HMW (EB2), HMX (EB2F), HMY (EB2M), HMZ (EB2), HMZ (EB2F), HNJ (EB2ADTXM), HNK (EB2ADT), HNK (EB2ADTD), HNK/EB2ADTD, HNL (EB2ADTSM), HNN (EB2ADTX), HNP (EB2ADT), HNS (EB2ADTS), HNS/EB2ADTS, HNT (EB2ADTS), HNV (EB2DT), HNV (EB2DTM), HNW (EB2DTS), HNW (EB2DTSM), HNX (EB2DT), HNX (EB2DTS), HNY (EB2DTS), HNZ (EB2DT), HN02, ZMZ (EBO), ZMZ (EBOF), 1PP (HM01)

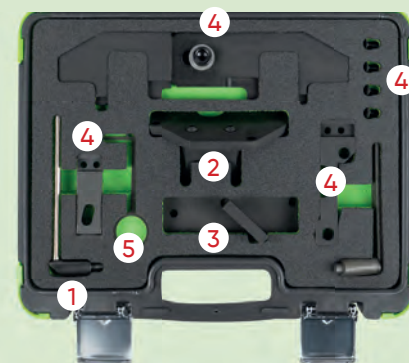

54213

19,80€

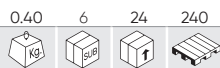

KIT DE BLOQUEIO DE DISTRIBUIÇÃO PARA ROVER/PEUGEOT/FORD/VOLVO 2.0, 2.2L D

MARCAS	PEUGEOT: 807 (05-11), 407 (05-11), 607 (05-09).CITROËN: C4 (04-10), C5 II (04-10). LAND ROVER: FREELANDER (06-10). VOLVO: S40 (03-10), V50 (06-10), C70 (06-10), S80 (07-10), C30 906-10), V70 (07-10).FORD: S MAX 2.2 (08-10), GALAXY 2.2 (08-10), MONDEO 2.2, 2.0 (07-10).
FERRAMENTAS OEM	PSA 0188.M, FORD 303-735, 303-1277, VOLVO 999-7122 (1) PSA 0188.X, FORD 303-1059, 303-1270, VOLVO 999-7121 (2) PSA 0188.F, FORD 303-393A, 303-393-01, 303-1272, VOLVO 999-7119/7120 (3)
CÓDIGOS DE MOTOR	PEUGEOT: DW10UTED4 (RHK), DW10BTED4 (RHR)DW12B-TED4 (4HS), (4HP), (4HT), (4HR). CITROËN: DW10BTED4 (RHR). LAND ROVER:DW12BTED4, 224DT. VOLVO:D420T 2.0D. FORD: QXBA(2.2), QXWA(2.0), QXBB(2.0),Q4BA(2.2), QXWA(2.0), QXWB(2.0), AZBA(2.0), AZBC(2.0), AZWA(2.0)

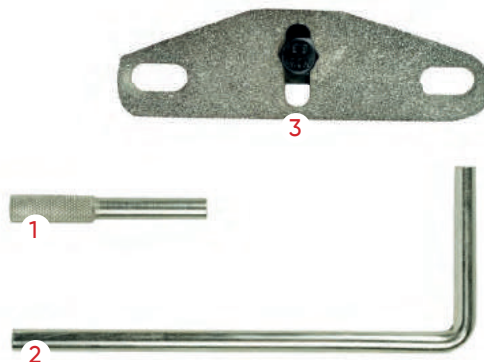

54432

43,00€



KIT DE BLOQUEIO MERCEDES PSA 2.7, 3.0 HDI

MARCAS	CITROËN C6 JAGUAR S-TYPE (X200) 2004 - 2008, XF S (X250) 2008 - 2015, XF S (X260) 2015 - 2020, XJ6 TDV1 (X350/358) 2005 - 2010, XJ (X351) 2010 - 2020, F-PACE S 30D (X761) 2016 - 2020 LAND ROVER: DISCOVERY 3 TDV6 (L319) 2004 - 2009, DISCOVERY 4/DISCOVERY SDV6, TDV6 (L319) 2009 - 2017, DISCOVERY SD6, TD6 (L462) 2017 - 2021, RANGE ROVER SDV6, SDV6 HYBRID, TDV6 (L405) 2012 - 2021, RANGE ROVER SPORT SDV6, TDV6 (L320) 2005 - 2013 PEUGEOT 407, 607 COUPE RANGE ROVER VELAR D275, D300 (L560) 2017 - 2021, RANGE ROVER SPORT SDV6, SDV6 HYBRID, TDV6 (L494) 2013 - 2021
FERRAMENTAS OEM	303 11117 (1), 303 11116 (2), 303 1132 (3), 303 1126 (4), 0195H (4), 0195C (5), 0195K (6), 0188-K (7)
CÓDIGOS DE MOTOR	2.7: DT17 TED4 (UHZ), DT17BTED4 (UHZ) 3.0: DT20C (X8C/X8Z), DT20CTED4 (X8Z)

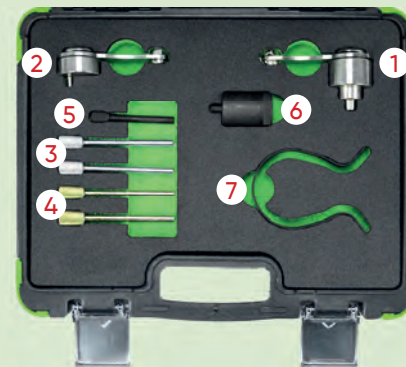

54433

18,00€

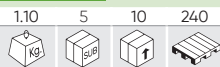

KIT DE BLOQUEIO PSA 1.0, 1.1, 1.2, 1.4, 1.6, 2.0

MARCAS	CITROËN BERLINGO 2008 - 2011, C2 2003 - 2010, C-ELYSEE 2012 - 2016, C3 PLURIEL 2003 - 2010, C4 2004 - 2011, NEMO 2008 - 2015, XSARA 2000 - 2005 PEUGEOT 106 1998 - 2003, 206 1998 - 2009, 207 2006 - 2013, 306 1998 - 2003, 307 2000 - 2008, 1007 2005 - 2010, PARTNER 1998 - 2011, BIPPER 2008 - 2015
FERRAMENTAS OEM	0132QY (1), 4507 TA (1), 0132AK (2), 0153AK (2), 0188K (2), 0189K (2), 1870 900 100 (2), 4533 TAD (2), MOT 1436 (2) 3MM PIN (3), 0132AB (4), 0178D (4), 0194A (4), 77440010400 (4), 1860.617000 (4), 11 9 790 (4), 21-260 (4), 303-732 (4), 4527 TS2 (4), 49 JEO2 018 (4), 5711 TD (4), 99360608 (4), 999 7169 (4), KM-6349 (4), 0132AJ1 (5), 0187B (5), 0189B (5), 0194B (5), 09919 58120 (5), 21 263 (5), 303 735 (5), 3031277 (5), 49 JEO2 021 (5), 607589011500 (5), 8MM DRILL BIT (5), 8MM PIN (5), 999 7122 (5), EN-52137 (5), MOT. 1430 (5), MOT 1430 (5), 0123-RZ (6), 0132R (6), 0153AA (6), 0153AB (6), 0153G (6), 0153ZY (6), 10MM PIN (6), 4507 TB (6), 7014 TN, 9767 27 (6), M10 X 70MM (6), 0132Q (7), 0132QZ (7), 132Z (7), 4507 TA (7)
CÓDIGOS DE MOTOR	1.0: TU9 (C1A), TU9/K (C1A), TU9M (CDY/CDZ), TU9MZ (CDY/CDZ), TU9M/L (CDZ), TU9M/L3 (CDY) 1.1: TU1A (HFV/HFX), TU1JP (HFV/HFY/HFZ), TU1JP/L4 (HFV), TU1/K (H1A), TU1M (HDZ), TU1M/L (HDZ), TU1M/L3 (HDY/HDZ), TU1M/Z (HDZ), TU1M+ (HDY/HDZ) 1.4: ET3J4 (KFU), ET3JP4 (KFU), TU3A (KFT/KFV/KFW), TU3FJ2 (K6B/KFZ), TU3FM (KDY), TU3JP (KFW/KFX/KFX), TU3JP/IFL4 (KFX)TU3JP/L3 (KFX), TU3JP/L4 (KFX), TU3JP/IFL4 (KFX), ET3J4 (KFU), TU3M (KDX), TU3M/Z (KDY) 1.6: ECS5 (NFP), ECS5F (NFP), TU5J2 (NFY/NFW), TU5J4 (NFU), TU5JP (NFT/NFZ), TU5JP/L3 (NFZ), TU5JP/L4 (NFT/NFV), TU5JP4 (NFU), TU5JP4B (NFR), TU5JP4S (NFS), TU5JP4/L3 (NFX), TU5JP4/L4 (NFU/NFX), XU5JP (BFZ) 1.8: XU7JB (LFX), XU7JP (LFW), XU7JP/L3 (LFZ), XU7JP4 (LFY), XU7JP4/L3 (LFY) 2.0: XU10J/C/Z (RFU), (RGX), XU10J2E/V (RGX), XU10J2U (RFL), XU10J4R (RFR/RFV), XU10J4R/L3 (RFV), XU10J4RS/L3 (RFS)

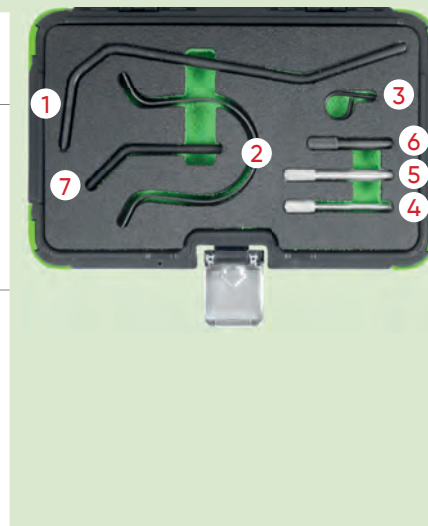

53293

134,00€

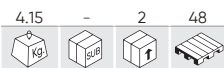

KIT DE BLOQUEIO FORD

MARCAS	B-MAX (12-17), C-MAX (07-17), COUGAR (98-01), COURIER (00-02), ESCORT (94-98), FIESTA (95-17), FOCUS (98-17), FOCUS C-MAX (03-07), FUSION (02-12), GALAXY (06-15), GRAND C-MAX (10-17), KUGA (08-15), MAVERICK (01-07), MONDEO (93-15), ORION (94-94), PUMA (97-02), S-MAX (06-15), TOURNEO CONNECT (02-15), TRANSIT (06-11), TRANSIT CONNECT (02-16), ECOSPORT (13-15), TOURNEO COURIER (14-15), GRAND TOURNEO COURIER (13-15).
FERRAMENTAS OEM	303-376 (21-162B) (1), 303-1059 (2), 303-193 (21-104) (3), 303-393-01 (4), 303-1054 (5), 303-1097 (6), 303-748 (7), 303-734 (21-262) (8), 303-651 (21-229) (9), 303-393A (21-168) / 303-393-02 / 303-507 (21-210) / 303-620 (21-163)/ 303-732 (21-260) / 303-735 (21-263).
CÓDIGOS DE MOTOR	PETROL: AODA/B, ASDA, ASDB, CFBA, CGBA/B, CHBA/B, CJBA/B, CSDA/B, DHA, DHB, DHC, DHD, DHE, DHF, DHG, EDBB, EDBD, EDDB, EDDC, EDDD, EDDF, EYDB, EYDC, EYDD, EYDE, EYDF, EYDG, EYDI, EYDJ, EYPA, EYPC, F8JA, F8JB, FHA, FHD, FHE, FHF, FUJA, FUJB, FXDA/C, FXDB/D, FXJA, FXJB, FYDA/C, FYDB/D, FYJA, FYJB, HWDA, HWDB, L1F, L1J, L1L, L1N, L1Q, L1T, L1V, L1W, M7JA, M7JB, MHA, MHB, NGA, NGB, NGC, NGD, QQDA/B/C, QQDB, RKA, RKB, RKF, RKH, RKJ, RKK, HXDA. GASOIL: F6JA, F6JB, F6JC, HHJA, HHJB, G8DA, HHDA, HHDB, RTN, RTQ, RTP, C9DC, BHDA/B, BHPA, C9DA/B, F9DA/B, FFBA, FFDA, HCPA, HCPB, KKDA, P7PA, P9PA, QYWA, R2PA, R3PA, RWPA, G6DA, G6DB, G6DC, AZWA, QXWA.

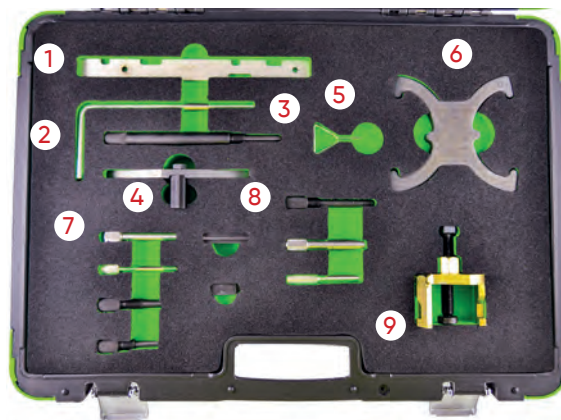

53294

119,00€



KIT DE BLOQUEIO FORD MAZDA

MARCAS	FORD: COURIER (00-02), C-MAX (03-10), FIESTA (02-11), FOCUS (98-11), FUSION (02-11), GALAXY (06-10), KUGA (06-10), MONDEO (07-10), S-MAX (06-10), TOURNEO CONNECT (02-13), TRANSIT CONNECT (02-13) PEUGEOT: BIPPER (08-10) DISPATCH/JUMPY III (07-12) EXPERT III (07-12) NEMO (08-10) PARTNER I/II (05-11) PARTNER III (08-16) 107 (05-10) 1007 (05-10) 206 (01-12) 206+ (09-13) 206 CC (05-07) 207 (06-13) 207 CC (07-15) 208 (11-15) 307 (01-08) 308 (07-15) 308 CC (09-15) 407 (05-11) 508 (04-15) 2008 (13-15) 3008 (09-15) 4008 (12-15) 5008 (09-15). MAZDA: 2 (02-15), 3 (09-14) CITROËN: C1 (05-10), C2 (03-10), C3 I/II (02-10), C3 III (10-15), C3 PLURIEL (04-10), C3 PICASSO (09-12), C4 (04-11), C4 II (11-15), C4 PICASSO (06-12), C4 GRAND PICASSO (10-12), DS3 (09-12), DS4 (11-12), DS5 (12-15), C5 II (04-08), C5 III (04-12), XSARA II (02-04), XSARA PICASSO (04-10)
FERRAMENTAS OEM	FORD: 303-376B (1), 303-193 (2), 303-393 (3), 303-732 (4), 303-651 (5), 303-393/01, 303-1059, 303-734, 303-735, MAZDA: 303-732, 303-734, 303-735. PSA: 0194-A, 0194-C, 0194B.
CÓDIGOS DE MOTOR	1.4D TDCi/Hdi: DV4TD(8HT), DV4TD(8HX), DV4TD(8HZ), DV4TD(8HW), DV4TED4(8HX), DV4TED4(8HV), DV4TED4(8HY), DV4C(8HP), DV4C(8HR), DV4TED(8HS), F6JA, F6JB, F6JC. 1.6D TDCi/HDi: DV6TED4(9HZ), DV6ATED4(9HX), DV6TED4(9HY), DV6DTE4(9HP), DV6C(9HR), DV6CATED(9HX), DV6C(9HL), DV6TED(9HP), DV6ATED(9HY), DV6TED4(9HV), DV6TED4(9HX), DV6C(9HD), DV6C(BHX), DV6C(BHZ), DV6(9HR), DV6BTED4(9HW), DV6DTE4(9HJ), DV6ETED(9HN), DV6ATED4BU(9HS), DV6BTED4(9HT), DV6BUTED4(9HT), DV6TED4B(9HV), DV6UTED4(9HX), DV6TED(9HD), DV6UTED4(9HU), DV6D(9HP), DV6TED4(9HV), DV6C (9HD), DV6TED4(9HW), DV6AT(9HX), DV6ATED(9HX), DV6CTED(9HC), DV6AUTED4(9HX), DV6TED4B, DV6DTE4(9HF), HHJA, HHJB, G8DA, G8DB, HHDA, HHDB, MZ-CD, Y6. 1.8D TDCi/HDi: BHPA, C9DA/B, FFBA, G6DA, G6DB, G6DC, HCPA, HCPB, KKDA, P7PA, P9PA, R2PA, R3PA, RWPA. 1.8d: C9DC, RTN, RTQ. 1.8D Td: C9DA/B, C9DC. 2.0D TDCi/HDi: AZWA, G6DA, G6DB, G6DC, RHE(DW10CTED4), QXWA, QXWB.

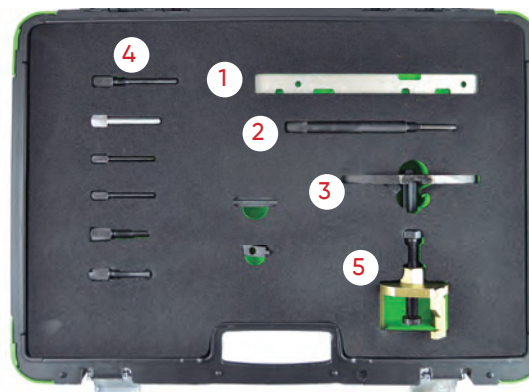

53318

24,00€



EXTRATOR DE PINHÃO DE EIXO DO COMANDO FORD

MARCAS	FORD
FERRAMENTAS OEM	F8M, F8Q, S8U, S9U.



53295

77,00€

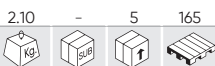

KIT DE BLOQUEIO FORD 1,8TDDI, TDCI

MARCAS	C-MAX (07-10), COURIER (00-02), FIESTA (00-02), FOCUS (98-11), FOCUS C-MAX (03-07), GALAXY (06-10), MONDEO (07-10), S-MAX (06-14), TOURNEO CONNECT (02-13), TRANSIT CONNECT (02-13).
FERRAMENTAS OEM	303-193 (21-104) (1), 303-393 (21-168) (2), 303-376 (21-162B) (3), 303-652 (21-230) (4), 310-095 (23-067) (5)
CÓDIGOS DE MOTOR	1.8D TDCI: BHFA, F9DA, F9DB, FFBA, FFDA, FFWA, HCPA, HCPB, KHBA, KKDA, KKDB, P7PA, P9PA, P9PB, QYBA, QYWA, R2PA, R3PA, RWPA, RWPC. 1.8D TDCI ECONETIC: KHBA. 1.8D TDI: BHDA, BHDB, BHFA, C9DA, C9DB, C9DC. 1.8D TURBO: C9DC, RTN, RTP, RTQ.



53296

60,00€

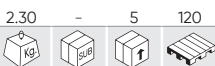

KIT DE BLOQUEIO PARA BOMBA DE INJEÇÃO FORD/JAGUAR DURATORQ

MARCAS	FORD: MONDEO (00-07), TRANSIT (00-14). CITROËN: RELAY, JUMPER III (06-13). FIAT: DUCATO (06-11).	JAGUAR: X-TYPE (03-10). PEUGEOT: BOXER III (06-12). LAND ROVER: DEFENDER TD4 (06-11). LDV: CONVOY (02-06).
FERRAMENTAS OEM	303-1151 (1), 303-679A/21-238 (2), 303-732 (3), 303-675/21-234 (4), 303-698/21-251 (5)	
CÓDIGOS DE MOTOR	1.2D DI/TDDI/TDCI: ABFA, D3FA, F3FA, D5BA, D6BA, F1FA, FMBA, FMBB, HJBA, HJBB, HJBC, HJBE, N7BA, N7BB. 2.2D TDCI/ECONETIC: BG, CYFA, CYFB, CYFC, DRFA, DRFB, DRFC, P8FA, P8FB, PGFA, PGFB, QJBA, QJBA (BG), QJBB, QJBC, QJBD, QVFA, QWFA, SRFA, SRFB, SRFC, SRFD, SRFE, UHFA. 2.2D HDI/JTD: P22DTE (4HM), P22DTE (4HU), P22DTE (4HV). 2.4D DI/TDCI: DOFA, D2FA, D2FB, D4FA, F4FA, FXFA, H9FA, H9FB, H9FD, JXFA, JXFC, PHFA, PHFC. 2.4D TD/TDI: ZSD 424. 2.4D TD4: 244DT.	



54419

57,00€

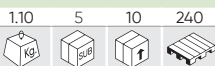

EXTRACTOR/INSTALADOR DO VEDANTE FRONTAL DA EIXO DE MANIVELAS FORD DURATORQ 2.0, 2.2, 2.4, 3.2

MARCAS	FORD MONDEO 2000 - 2007 RANGER 2011 - ON TRANSIT 2000 - 2006 TRANSIT 2006 - 2014 TRANSIT 2014 - 2019 TRANSIT/TOURNEO CUSTOM 2012 - 2016
FERRAMENTAS OEM	21 238 (1), 303-679A (1), 303-682 (2)
CÓDIGOS DE MOTOR	2.0 Di ABFA D3FA F3FA 2.0 TDCI FMBA FMBB HJBA HJBB HJBC N7BA N7BB SDBA F1FA 2.0 TDDi D5BA D6BA 2.2 TDCI QJBA QJBB QJBC QJBD GBVAJQJ GBVAJQJ GBVAJQJ CVRA CVRB CYFA CYFB CYFC CYRA CYRB DRFA DRFB DRFC DRFE DRRB DRRB P8FA P8FB PGFA PGFB QVFA QWFA SRFA SRFB SRFC SRFD SRFE UHFA UHFB 2.4 Di D2FA D2FB D4FA DOFA F4FA FXFA 2.4 TDCI H9FA H9FB H9FD JXFA JXFC 3.2 TDCI SAFA SA2R SA2S SA2W SAFA SAFB



54420

102,00€



N

CONJUNTO DE AJUSTE DE COMBUSTÍVEL – FORD/VOLVO 2.5 (EURO 4)

MARCAS	FORD: FOCUS 2.5 RS / ST, MONDEO 2.5, S-MAX 2.5, GALAXY 2.5 ST (2005-) VOLVO: C30 (06-10), C70 (98-10), S40 (96-10), S60 (00-09), S70 (97-07), S80 (98-06), V40 (96-10), V50 (04-10), V70 (97-07), XC70 (02-07), XC90 (02-10)
FERRAMENTAS OEM	303-1178 (1), 999 5452 (1), MOT 1337 (1) 303-1182 (2), 999 5451 (2), MOT 1340 (2) 303-1179 (3), 999 5433 (3) 303-1183 (4)
CÓDIGOS DE MOTOR	FORD: 2.5 Turbo (Euro 4), HUBA / HUWA / HYDA / JZDA VOLVO: 1.6 (B4164S), 1.8 (B4184S), 1.9T (B4194T), 2.0 (B4204S / B4204T), 2.0T (B5204T3 / B5204T4 / B5204T5), 2.3 (B5234FS), 2.3T (B5234T3 / B5234T7 / B5234T9) VOLVO: 2.4 (B5244S / B5244S2 / B5244S4 / B5244S5 / B5244S7), 2.4T (B5244T / B5244T3 / B5244T4 / B5244T5 / B5244T7), 2.5R (B5254FS), 2.4D (D5244T9 / D5244T8 / D5244T13)

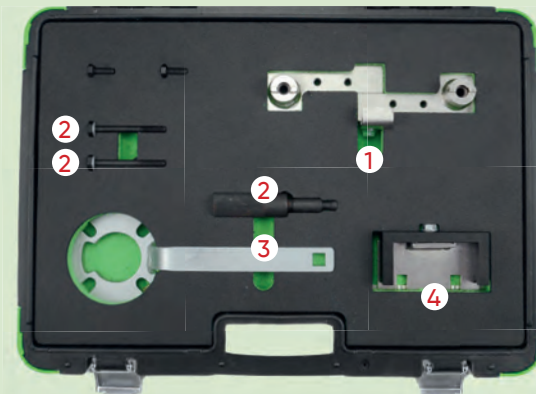

54421

52,00€



N

INSTALADOR DE CORREIA AUXILIAR FORD/VOLVO 1.4 1.6

MARCAS	FORD 1.4, 1.6 (FOCUS, C-MAX, MONDEO) VOLVO 1.6 (S40, C30, V50)
FERRAMENTAS OEM	303-1179
CÓDIGOS DE MOTOR	B4164S3, FUJA, FXJA, FYJA C12HM7AD, C12LM7AA, ZH12FUJA, ZH12FUJB, ZH12M7JB C14HDEZ, C14HHADB, ZH14ASDA, ZH14FXDA, ZH14FXDB, ZH-14FXDC, ZH14FXDD, ZH14FXJA, ZH14FXJB 16HDEZ, CH16HDEZ, C16HHDEY, ZH16FYDA, ZH16FYDB, ZH16FYDC, ZH16FYDD, ZH16FYDH, ZH16FYJA, ZH16FYJB, ZH16HWDA, ZH16HXDA



54424

64,50€



N

KIT DE BLOQUEIO FORD 2.0 ECOBOOST

MARCAS	FOCUS, GALAXY, MONDEO, S-MAX
FERRAMENTAS OEM	303-1504 (1) 303-1600 (2), 300-1565 (2) 303-1521 (3) 303-748 (4) 303-1595 (5) 2MM TENSIONER (6)
CÓDIGOS DE MOTOR	MGDA, R9CB, R9CD, R9CF, R9CH, R9DA, R9DB, R9DC, R9DD, TNBA, TNBB, TNCC, TNCD, TNCF, TNWA, TNWB, TPBA, TPWA, TVDA, XQDA

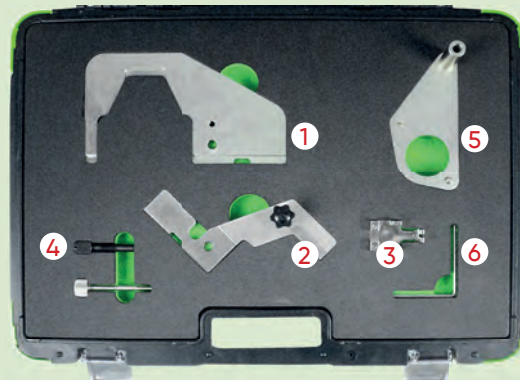

53324

12,50€

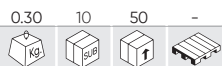

KIT DE BLOQUEIO FORD

MARCAS	FORD: B-MAX (15-17), C-MAX (07-10), COUGAR (98-01), FIESTA (95-17), FOCUS (98-11), FOCUS C-MAX (03-07), FUSION (02-12), GALAXY (06-15), MAVERICK (01-07), MONDEO (93-15), PUMA (97-02), S-MAX (06-15), TOURNEO CONNECT (02-06), TRANSIT (06-12), TRANSIT CONNECT (02-06). MAZDA: 121 ZG (95-00), 2 DY (02-07), 3 BK (03-09), 3 BL (09-15), 5 CR (05-10), 5 CW (10-12), 6 GG/GY (02-07), 6 GH (07-15), MPV LW (02-05), MX-5 NC (05-16), TRIBUTE EP (04-06). VOLVO: C30 (06-13), S40 (06-12), S80 (07-11), V50 (04-12).
FERRAMENTAS OEM	FORD: 303-1054, 303-507 (21-210), 303-620 (21-163), 303-574, 303-748, 303-376 (21-162B), 303-376B MAZDA: 49 JE01 061, 303-574, 49 JE02 061, 303-465, 49 JE01 054 VOLVO: 999 7152, 999 7151.
CÓDIGOS DE MOTOR	1.4 / 1.6



53653

207,00€



KIT DE BLOQUEIO FORD

MARCAS	FORD: FIESTA, FOCUS, B-MAX, ECOSPORT.
FERRAMENTAS OEM	303-1605 (1), 303-1606 (2), 303-1604 (3), 303-1602 / 503-393A / (21-168) (4), 303-1054 (5), 303-732 (6)
CÓDIGOS DE MOTOR	M1DD, M1JA, M1JC, M1JE, M1JHM1JJ, M1DA, M2DA, M2DB, M2DC, SFDBSFJA, SFJB, SFJC, SFJD

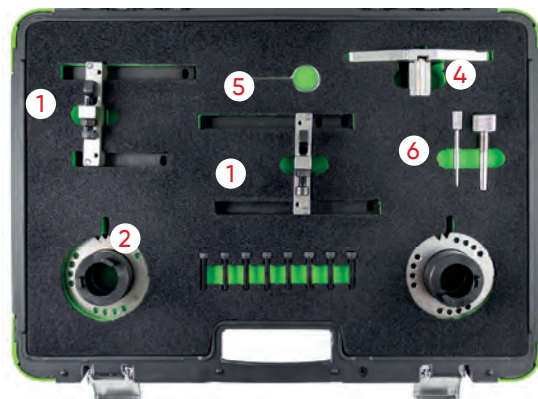

54201

37,60€



CONJUNTO DE FERRAMENTAS DE REGULAÇÃO DO MOTOR FORD

MARCAS	FORD: C-MAX(07 - 10), C-MAX/GRAND C-MAX(10-18), FIESTA(08-18), FOCUS/FOCUS C-MAX(04-11), FOCUS(11-18), MONDEO(07-15)
FERRAMENTAS OEM	303-1097 (1), OEM 303-1054 (2), OEM 303-1059, 303-1270, 0188X, 999-7121 (3), OEM 303-748, 999-7152, 21-259 (4), OEM 303-735, 999 7122, 0187B, 0189B, 0132AJ1, 21-263, 0188M, MOT 1430, 303-1277, 0194B (5)
CÓDIGOS DE MOTOR	11.6 TI-VCT HXDA (2003-2007) ,2.0 TDCI , G6DA, G6DB, G6DC 2003-2007



54204

124,00€

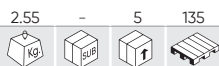

KIT DE BLOQUEIO DE DISTRIBUIÇÃO PARA FORD 2.0 ECOBLUE

MARCAS	FORD EDGE, FOCUS, GALAXY, S-MAX (FROM 2018); KUGA, MONDEO, RANGER (DESDE 2019); TRANSIT, TRANSIT CUSTOM AND TOURNEO CUSTOM (DESDE 2016); TODOS CON MOTOR ECOBLUE TDCI ; AWD, FWD Y RWD.
FERRAMENTAS OEM	303-1637 (1), 303-1650 (2), 303-1643 (3).
CÓDIGOS DE MOTOR	BCCC,YLCB,YLDA,YLF6,YLFA,YLFB,YLFS,YLR6,YLRA,YMCB,YM-F6,YMFA,YMFB,YMFS,YMHA,YMRA,YNCA,YNF6,YNFA,YNFB,YNFS,Y-NR6,YNRA

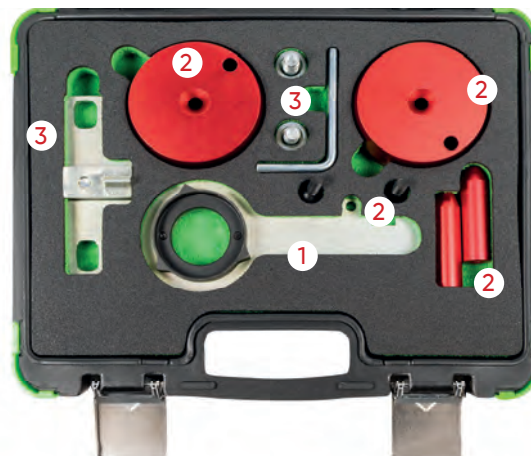

54208

76,00€

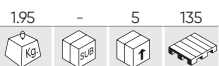

KIT DE BLOQUEIO DE DISTRIBUIÇÃO PARA FORD 2.0 ECO BOOST SCTI, TI-VCT

MARCAS	FORD: GALAXY(2010)MONDEO (2010) S MAX (2010) FOCUS(2011)
FERRAMENTAS OEM	303-748 (1), 303-1504 (2), 303-1565 (3), 303-1521 (4)
CÓDIGOS DE MOTOR	TNWA, TNWB, TPWA, TNBA, TPBA, MGDA, XQDA

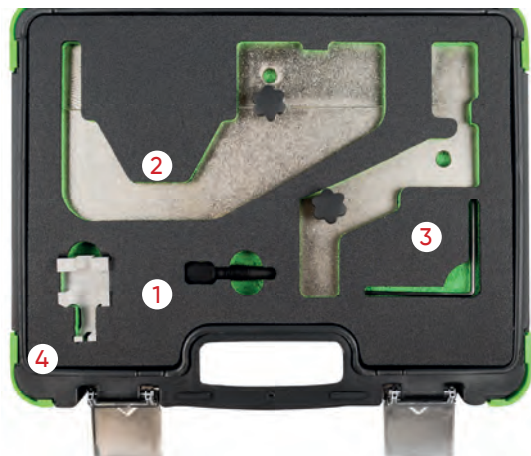

54209

29,70€

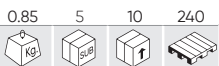

KIT DE BLOQUEIO DE DISTRIBUIÇÃO PARA FORD/MAZDA 2.2, 3.2 TDCI

MARCAS	FORD_RANGER 3.2L (2011-2016) FORD_RANGER 2.2L (2011-2015) FORD_TRANSIT 2.2L (2006-2016) FORD_EVEREST 3.2L (2015) FORD_RANGER 3.2L (2011) MAZDA BT-50 (2011) MAZDA BT-50 3.2L (2011-2016)
FERRAMENTAS OEM	303-675/21-234,303-698/21-251 (1), 303-1587 (2)
CÓDIGOS DE MOTOR	CYFA,CYFB,DRFA,DRFB,P8FA,P8FB,PGFA,PGFB,QVFA,QWFA,SR-FA,SRFB,SRFC,SRFD,SEFE,UHFA,CYFC,DRFC,USRA



54223

149,00€



FERRAMENTA DE BLOQUEIO DE ÁRVORE DE CAMAS PARA FORD 1.5T

MARCAS	FORD_1,5L DURATEC, ECOSPORT, FIESTA, FOCUS
FERRAMENTAS OEM	303-1639 (1), 303-1643 (2), 303-1647 (3), 303-1648 (4)
CÓDIGOS DE MOTOR	2.2 / 2.5

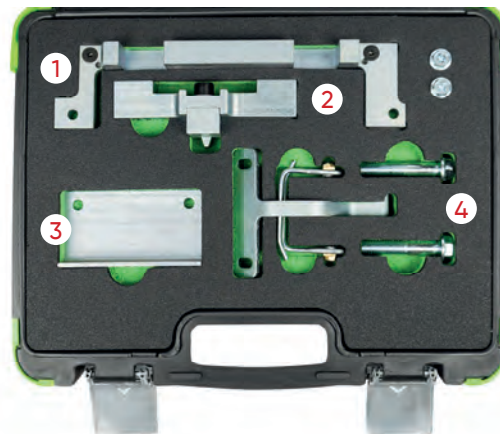

54224

64,50€



KIT DE INSTALAÇÃO/REMOÇÃO DE BOMBA DE INJEÇÃO PARA FORD 2.0

MARCAS	FORD: TRANSIT (17-18), TOURNEO CUSTOM (16-18), TRANSIT CUSTOM (16-18)
FERRAMENTAS OEM	303-1635 (1)/3, 3.3--1635 (2)/1, 303-1635 (3)/2, 303-1635/6 (4)
CÓDIGOS DE MOTOR	YLFS, YMFS, YNFS, YLF6, YMF6, YNF6, YLR6, YMR6 AND YNRS.

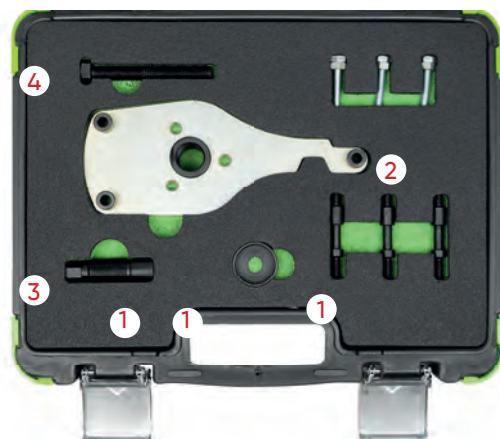

54260

277,00€

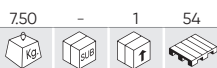

KIT DE MULTIPLICADOR DE FORÇA 5:1 PARA MOTORES FORD ECOBOOST



1.0 Ecoboost
1.0 Duratec
2.0 Duratec

2.0 Durator-TDCi
2.0 EcoBlue Diesel



53297

45,00€

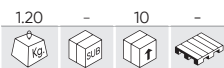

KIT DE BLOQUEIO JAGUAR/LAND ROVER

MARCAS	JAGUAR: MS TYPETDVI. LAND ROVER: DISCOVERY 2.7 TDV6. RANGE ROVER: SPORT 2.7 TDV6.
FERRAMENTAS OEM	303-1117 (1), 303-1116 (2), 303-1132 (3), 303-1126 (4) (5)
CÓDIGOS DE MOTOR	276DT, 306DT.

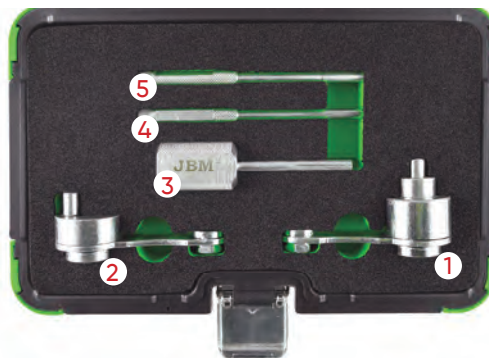

53298

91,00€

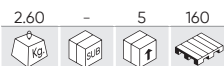

KIT DE BLOQUEIO LAND ROVER

MARCAS	MOTOR DIESEL: 200 TDI. 300 TDI. 2.5
--------	-------------------------------------

- Pino de sincronização de transmissão manual.
- 200 tdi. 300 tdi. 2.5 motores diésel.
- Extrator de amortecedor de cambota.
- Ferramenta de bloqueio da bomba de injeção.
- Perno de sincronização da bomba de injeção 200/300 tdi.
- Ferramenta de sincronização do volante do motor 200/300 tdi.
- Ferramenta de sincronização da bomba dsp 2.5.
- Ferramenta de sincronização do volante do motor 2.5.



54422

140,00€



KIT DE AJUSTE DO EIXO DE EQUILÍBRIO JAGUAR/LAND ROVER 2.0D

MARCAS	JAGUAR: E-PACE D150, D180, D240 (X540) (2017-), F-PACE 20D, 25D, E-PERFORMANCE (X761) (2016-), XE 20D, 25D, E-PERFORMANCE (X760) (2015-), XF 20D, 25D, E-PERFORMANCE (X260) (2015-) LAND ROVER: DEFENDER SD4 D200, SD4 D240 (L663) (2019-2021), DISCOVERY SPORT ED4, SD4, TD4, D150, D180, D240 MHEV (L550) (2015-), DISCOVERY SD4, TD4 (L462) (2017-2021) RANGE ROVER: EVOQUE ED4, SD4, TD4 (L538) (2015-2019), EVOQUE D150, D180, D240 MHEV (L551) (2019-), SPORT SD4 (L494) (2016-2018), VELAR D180, D240 (L560) (2017-)
FERRAMENTAS OEM	JLR-303-1662 (1) JLR303-1663-1 (2) JLR303-1663-2 (3) JLR303-1663-3 (4) JLR-303-1664 (5) JLR-303-1665 (6)
CÓDIGOS DE MOTOR	2.0: AJ200D,AJ200/204DTA,AJ200/2004DTD 2.0: AJ-200D/204DT, AJ-200D/204DTA



54423

108,00€



N

KIT DE BLOQUEIO LAND ROVER 3.6D

MARCAS	RANGE ROVER SPORT; 3.6 (TDV8) DIESEL (2006-2011) RANGE ROVER; 3.6 (TDV8) DIESEL (2006-2011)
FERRAMENTAS OEM	303-1236 (1) 303-1243 (2) 303-1239 (3) 303-1238 (4)
CÓDIGOS DE MOTOR	368DT

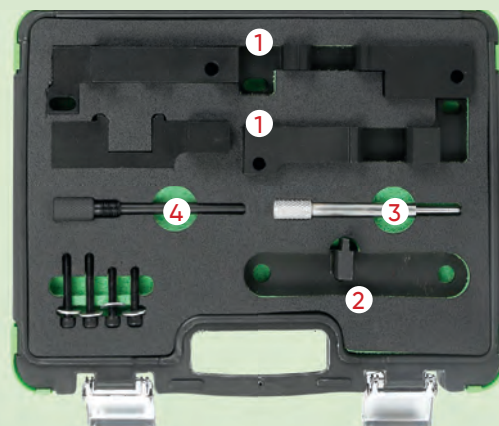

54425

124,00€



N

KIT DE BLOQUEIO LAND ROVER FREELANDER V6/ROVER KV6 2.0L, 2.5L

MARCAS	LAND ROVER; FREELANDER (2000-2006) MG; ZR (2004-2005), ZS (2001-2005), ZT (2001-2005) ROVER; 45 (1999-2005), 75 (1999-2005), 825 (1996-1999)
FERRAMENTAS OEM	LRT 12-175 (1) LRT 12-187 (2) LRT 12-195 (3) LRT 12-196 (4) LRT 12-198 (5) LRT 12-232 (6)
CÓDIGOS DE MOTOR	LAND ROVER; 2,5 KV6 MG; 2,0 KV6, 2,5 KV6 ROVER; 2,0 KV6 2,5 KV6

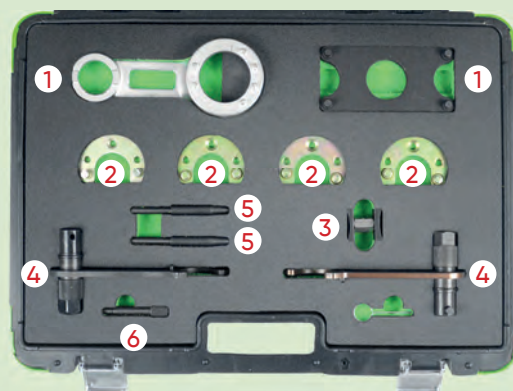

54426

69,00€



N

KIT DE BLOQUEIO JAGUAR/LAND ROVER 3.2, 3.5, 4.0, 4.2, 4.4

MARCAS	DAIMLER; V8 (97-03), SUPER V8 (97-03), SUPER EIGHT (05-10). JAGUAR; S-TYPE (99-08), XF (08-09), XJR (97-10), XJ8 (97-10), XKR (98-09), XK8 (96-09) LAND ROVER; DISCOVERY III (04-09) RANGE ROVER (05-09), RANGE ROVER SPORT (05-09)
FERRAMENTAS OEM	303530 (1) 303531 (2) 303532 (3) 303533 (4) 303645 (5) 303654 (6) T40011 (7)
CÓDIGOS DE MOTOR	3.2: AC,KB,KC 3.5: RB 4.0: BC, CC,CE,DC,EC,GB,GC,LB,LC,MA,MB,NB,NC,PA,PB 4.2: 1B,2B,3B,1G,5G,9G,HB,HG,SB,TB,PC,428PS 4.4: 448PN



54427

113,00€



N

FERRAMENTA DE BLOQUEIO DA POLIA DA CAMBOTA JAGUAR/LAND ROVER 4.0, 4.2, 4.4

MARCAS	DAIMLER: V8; 4.0 (97-98) JAGUAR: S-TYPE; 3.2, 3.5, 4.2 V8 (99-08), XF; 3.2, 3.5, 4.2 V8 (08-09), XJ; 3.2, 3.5, 4.2 V8 (97-08), XJ8; 4.0 (97-98), XK; 3.2, 3.5, 4.2 V8 (97-08), XK8; 4.0 (97-98) LAND ROVER: DISCOVERY3; 4.2, 4.4 LA V8 (05-09) RANGE ROVER; 4.2, 4.4 SPORT LS V8 (05-09), RANGE ROVER; 4.2, 4.4 LM V8 (06-08)
FERRAMENTAS OEM	LRT 12 080 18G 1437 18G 1437 2 303 191 303 191 03 303 191 04 303 588 303 893
CÓDIGOS DE MOTOR	AJ26, AJ27, AJ28, AJ34 30G,36D,42D,56D,58D,94D,428PS,448PN



54428

31,00€



N

KIT DE BLOQUEIO CHRYSLER/JEEP 2.8 CRD

MARCAS	CHRYSLER GRAND VOYAGER 2008 - 2015 DODGE NITRO 2007 - 2011 JEEP CHEROKEE 2008 - 2013, WRANGLER 2007 - 2018
FERRAMENTAS OEM	VM 9991 (1) VM 9992 (2)
CÓDIGOS DE MOTOR	VM64C, ENS, ENS (51C), 49C, 50C, ENS VM10D, ENS VM11D



54429

55,00€



N

KIT DE BLOQUEIO CHRYSLER/JEEP 3.0D

MARCAS	CHRYSLER 300 C 2012 - 2015 JEEP GRAND CHEROKEE 2011 - ON
FERRAMENTAS OEM	VM 10338 1 (1) VM 10338 2 (2) VM 10359A (3), VM 10359 (3) VM 10339 (4), VM 10359 (4)
CÓDIGOS DE MOTOR	3.0 CRD: EXF 3.0 CRD/MULTIJET: EXF VM23D, EXF VM44D, EXF VM44D, EXF VM63D

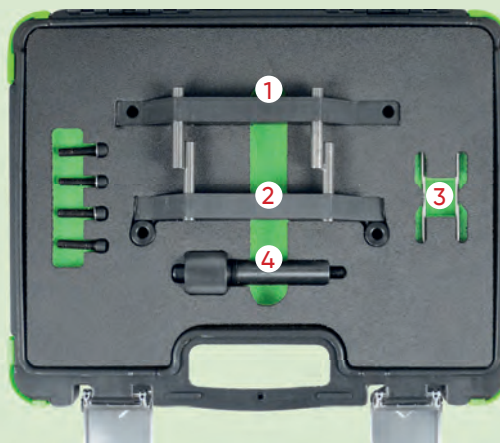

54207

38,90€

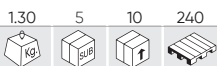

KIT DE BLOQUEIO DE DISTRIBUIÇÃO PARA CHRYSLER/JEEP 2.5 LDV CRD

MARCAS	CHRYSLER: VOYAGER (01-08), GRAND VOYAGER (01-08) JEEP: CHEROKEE (01-08) LDV: MAXUS (05-09)	
FERRAMENTAS OEM	VM 9660 (1), VM1052 (2), VM1053 (3), VM1068 / VM1089 (4), VM1080 (5), VM8873 (6)	
CÓDIGOS DE MOTOR	2.5D CRD: R2516C, R2516K, R2516LVM39/40B.	2.8D CRD: R2816C5.05A, R2816K4.



53270

70,00€

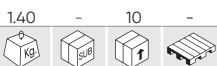

KIT DE BLOQUEIO MERCEDES/CHRYSLER/JEEP

MARCAS	MERCEDES CHRYSLER JEEP
FERRAMENTAS OEM	112589034000 (1), 601589024000 (2), 111589031500 (3)
CÓDIGOS DE MOTOR	HERR.: 112 589 03 40 00; 112, 113, 137, 155, 156, 272/979, 273, 629, 642/992. HERR.: 601 589 02 40 00: 102, 103, 104, 111, 601, 602.91/93/94/96/983, 603.91/93/96/97, 604, 605, 606, 611, 612/965/966, 613. HERR.: 111 589 03 15 00: 111, 119, 604, 605, 606, 611/980, 612, 613, 628, 629, 640, 642/922, 612.965/966, 646, 647, 648.

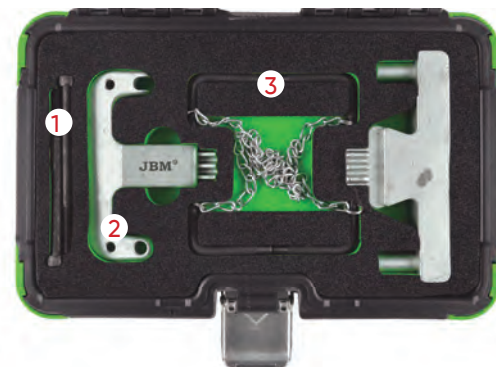

53271

227,00€



KIT DE BLOQUEIO MERCEDES BENZ M271

MARCAS	MERCEDES
FERRAMENTAS OEM	271 589 003100 (1), 271589014000 (2), 271589001500 (3), 156589006100 (4)
CÓDIGOS DE MOTOR	M271. E18ML 2002. DE18ML 2003 - 2005. E16ML 2008. DE18LA 2009.

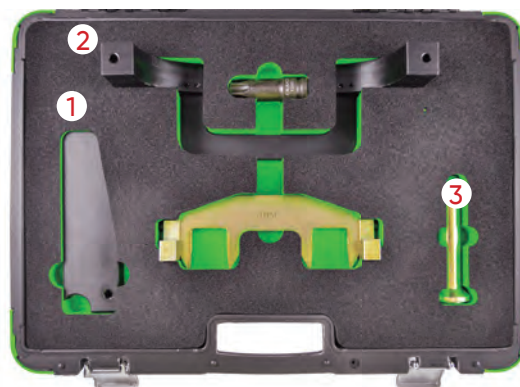

53272

195,00€

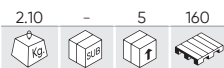

KIT DE BLOQUEIO MERCEDES AMG 156

MARCAS	MERCEDES
FERRAMENTAS OEM	156589006100 (1), 156589003200 (2), 156589016300 (3), 156589006900 (4)
CÓDIGOS DE MOTOR	BENZ AMG 156.ML 63 AMG.S 63L AMG.S 63. AMG. R 63 AMG L 4MATIC. R63 AMG 4MATIC. E 63 AMG. CLS 63 AMG. CLK 63 AMG BLACK SERIES. CLK 63 AMG CABRIO. CL 63 AMG.

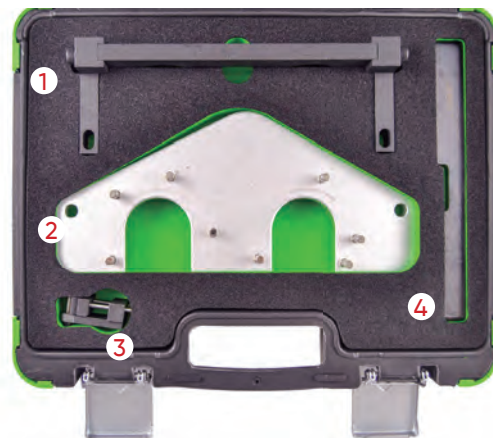

53273

75,00€

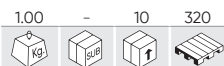

KIT DE BLOQUEIO MERCEDES M276, M157, M278

MARCAS	MERCEDES		
FERRAMENTAS OEM	27658901400		
CÓDIGOS DE MOTOR	<table border="0"> <tr> <td>CL 500 / 63 AMG (C 216) 2010-2013. S 500 / 63 AMG (C 217) 2014. CLS 300 (C 218) 2012. E 300 / 350 / 400 (C/A 207) 2011. CLS 350 / 400 / 500 / 63 AMG (C/X 218) 2011-2014. SLK 350 (R 172) 2011. SL 350 / 400 / 500 / 63 AMG (R 231) 2012. S 500 PLUG-IN HYBRID (V 222) 2014. ML 300 / 350 / 500 / 63 AMG (W 166) 2011.</td> <td>C 400 (W 205) 2014. E 400 HYBRID (W 212) 2012. G 63 AMG (W 463) 2012. E 300 / 350 / 400 / 500 / 63 AMG (W/S 212) 2011. C 350 (W/S/C 204) 2011. S 350 / 500 / 63 AMG (W/V 221) 2010. S 400 / 63 AMG (W/V 222) 2013. R 350 BlueEFFICIENCY (W/V 251) 2012. GL 450 / 500 (X 166) 2012. GLK 350 (X 204) 2011.</td> </tr> </table>	CL 500 / 63 AMG (C 216) 2010-2013. S 500 / 63 AMG (C 217) 2014. CLS 300 (C 218) 2012. E 300 / 350 / 400 (C/A 207) 2011. CLS 350 / 400 / 500 / 63 AMG (C/X 218) 2011-2014. SLK 350 (R 172) 2011. SL 350 / 400 / 500 / 63 AMG (R 231) 2012. S 500 PLUG-IN HYBRID (V 222) 2014. ML 300 / 350 / 500 / 63 AMG (W 166) 2011.	C 400 (W 205) 2014. E 400 HYBRID (W 212) 2012. G 63 AMG (W 463) 2012. E 300 / 350 / 400 / 500 / 63 AMG (W/S 212) 2011. C 350 (W/S/C 204) 2011. S 350 / 500 / 63 AMG (W/V 221) 2010. S 400 / 63 AMG (W/V 222) 2013. R 350 BlueEFFICIENCY (W/V 251) 2012. GL 450 / 500 (X 166) 2012. GLK 350 (X 204) 2011.
CL 500 / 63 AMG (C 216) 2010-2013. S 500 / 63 AMG (C 217) 2014. CLS 300 (C 218) 2012. E 300 / 350 / 400 (C/A 207) 2011. CLS 350 / 400 / 500 / 63 AMG (C/X 218) 2011-2014. SLK 350 (R 172) 2011. SL 350 / 400 / 500 / 63 AMG (R 231) 2012. S 500 PLUG-IN HYBRID (V 222) 2014. ML 300 / 350 / 500 / 63 AMG (W 166) 2011.	C 400 (W 205) 2014. E 400 HYBRID (W 212) 2012. G 63 AMG (W 463) 2012. E 300 / 350 / 400 / 500 / 63 AMG (W/S 212) 2011. C 350 (W/S/C 204) 2011. S 350 / 500 / 63 AMG (W/V 221) 2010. S 400 / 63 AMG (W/V 222) 2013. R 350 BlueEFFICIENCY (W/V 251) 2012. GL 450 / 500 (X 166) 2012. GLK 350 (X 204) 2011.		



54318

105,00€

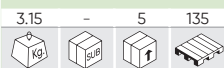

REBITADOR DE CORRENTE DE DISTRIBUIÇÃO

MARCAS	CHRYSLER JEEP MERCEDES
FERRAMENTAS OEM	112 589 026 300 (1) 103 589 016 300 (2) 602 589 026 300 (3) 602589023300 (4) 602589003900 (5) 602589046301 (6)
CÓDIGOS DE MOTOR	CHRYSLER/JEEP: 2.2D, 2.7D, 3.0D CRD (DIESEL). MERCEDES: 1.7D, 2.1D, 2.2D, 2.7D, 3.0D, 3.2D, 3.9D, 4.0D CDI (DIESEL)

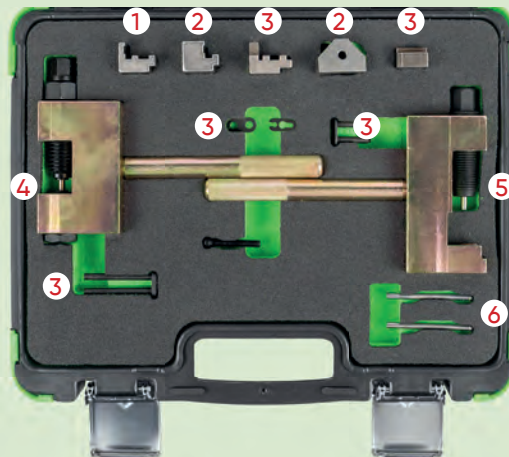

54414

97,50€



N

KIT DE BLOQUEIO MERCEDES M651

MARCAS	A CLASS (2012-2018), B CLASS (2012-2019), C CLASS (2009-2015), C CLASS (2014-2018), CLA COUPE (2013-2019), CLS (2011-2018), E CLASS (2009-2016), GLA (2014-2020), GLC (2015-2019), GLE (2015-2019), GLK (2008-2015), M CLASS (2011-2015), S CLASS (2010-2013), S CLASS (2013-2017), SLC (2016-2017), SLK (2012-2016), SPRINTER (2009-2018), SPRINTER (2018-), V CLASS (2014-), VIANO (2010-2015), VITO (2010-2015), VITO (2014-) MERCEDES-BENZ
FERRAMENTAS OEM	608 31 800 (1) 608 31 830 (2) 608 31 810 (3) 608 31 820 (4) 651 589 00 40 00 (5)
CÓDIGOS DE MOTOR	1.8: 651.901 2.1: 651.900, 651.910, 651.911, 651.912, 651.913, 651.916, 651.921, 651.922, 651.924, 651.930, 651.940, 651.950, 651.955, 651.956, 651.957, 651.958, 651.960, 651.961, 651.980 2.2: 651.925

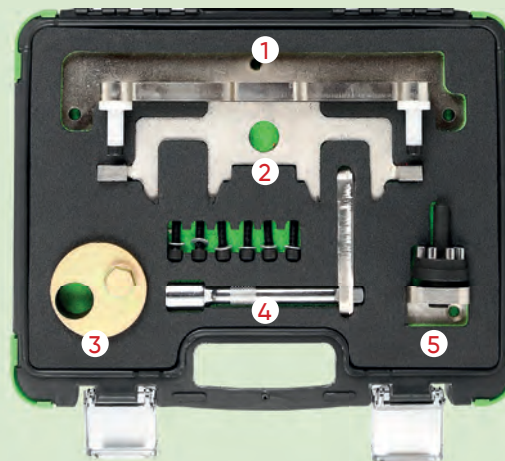

54415

60,00€



N

KIT DE BLOQUEIO MERCEDES M651

MARCAS	GLA X156 200/220 CDI, GLK X 204 200/220/250 CDI, ML W166 250, SLK R172 250 CDI, SPRINTER W906 210/310/510/213/313 CDI, SPRINTER W906 513/216/316/416/516 CDI, V-CLASS W/V 639 2.0/2.2 CDI, VITO W/V 639 110/113/116 CDI MERCEDES-BENZ: A-CLASS W176 180/200/220 CDI, B-CLASS W246 200/220 CDI, C-CLASS W/S/C 204 180/200/220/250 CDI, CLA C117 200/220 CDI, CLD C/X 218 220/250, E-CLASS W/S 212 200/220/250 CDI E-CLASS C/A 207 220/250 CDI, E-CLASS W212 250/300 BLUETEC
FERRAMENTAS OEM	651589004000 (1) 651589014000 (2)
CÓDIGOS DE MOTOR	1,8 651.901 2,1 651.900 651.910 651.911 651.912 651.913 651.916 651.921 651.922 651.924 651.925 651.930 651.940 651.950 651.955 651.956 651.957 651.958 651.960 651.961 651.980

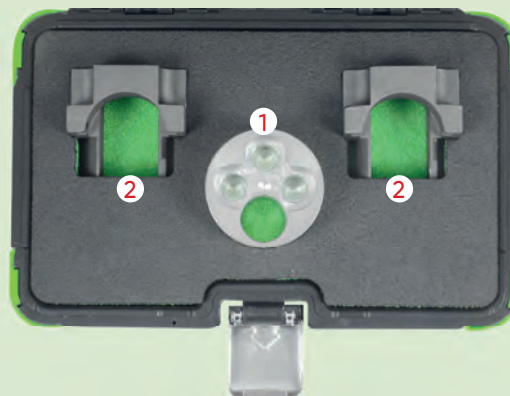

54416

31,00€



N

KIT DE BLOQUEIO MERCEDES M642

MARCAS	G-CLASS (461/463) 2007-2015, GL-CLASS (164/166) 2006-2016, GLE/GLE COUPE (166/292) 2020 GLK (204) 2008-2015, GLS (166) 2016-2019, M-CLASS (164/166) 2005-2015, R-CLASS (251) 2005-2013, S-CLASS (221/222) 2005-2017, SPRINTER (906) 2006-2018, VIANO (639) 2005-2015, VITO (639) 2006-2015 MERCEDES-BENZ: C-CLASS (203/204) 2004-2014, CLK (209) 2005-2009, CLS (219/218) 2005-2018, E-CLASS (211/212/213) 2005-2018, E-CLASS COUPE/CABRIOLET (207) 2009-2017
FERRAMENTAS OEM	642589003100 (1)
CÓDIGOS DE MOTOR	642.820 642.822 642.826 642.830 642.832 642.834 642.835 642.836 642.838 642.850 642.852 642.853 642.854 642.855 642.856 642.858 642.861 642.862 642.867 642.868 642.870 642.872 642.884 642.886 642.890 642.896 642.910 642.920 642.921 642.922 642.930 642.932 642.940 642.950 642.960 642.961 642.970 642.975 642.990 642.992 642.993

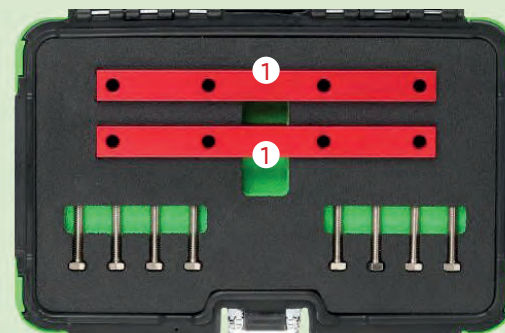

54417

153,00€



N

KIT DE BLOQUEIO MERCEDES M133, M270, M274

MARCAS	MERCEDES.BENZ A -CLASS (W176) (2012), MODEL A180/A200 MERCEDES.BENZ B CLASS (W246) AS OF 2011, MODEL B180/B200
FERRAMENTAS OEM	270589006100 (1)
CÓDIGOS DE MOTOR	M133 M270 M274

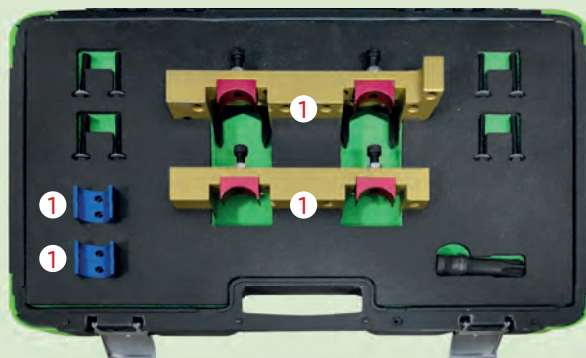

54418

37,00€



N

KIT DE BLOQUEIO MERCEDES M112, M113

MARCAS	C-CLASS (202) 2.4/2.6/2.8/3.2/4.3 - 1998-00, CLK (208) 3.2/4.3/5.4 - 1997-03, E-CLASS (210) 2.4/3
FERRAMENTAS OEM	112589003200 (1) 112589013200 (2) 112589000100 (3)
CÓDIGOS DE MOTOR	MERCEDES.BENZ: M112, M113

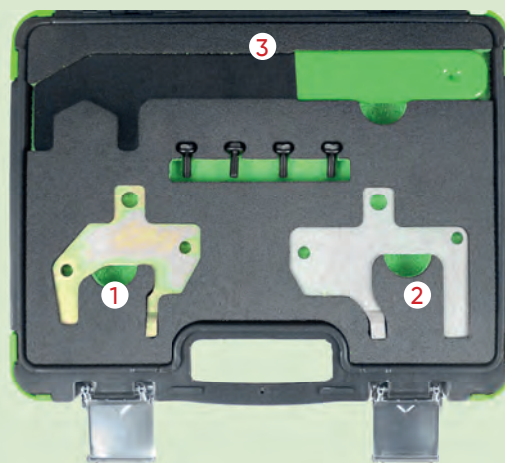

51488

16,00€

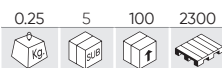

BLOQUEADOR DE CAMBOTA E ÁRVORE DECAMES RENAULT/NISSAN/DACIA/SUZUKI

MARCAS	RENAULT: CAPTUR, CLIO II.III.IV, ESPACE/GRAND ESPACE III.IV, FLUENCE, KADJAR, KANGOO, LAGUNA I,II,III, LOGAN/ LOGAN MCV, MEGANE I,II,III,IV, MODUS/GRAND MODUS, SCENIC/ GRAND SCENIC I,II,III,IV, TWING II, TRAFIC II, MASTER II 1.5DCI & 1.9 DCI. DACIA: DOKKER, DUSTER, LODGY, LOGAN, SANDERO 1.5DCI NISSAN: ALMERA, CUBE, JUKE, KUBISTAR, MICRA, NOTE, NV200/EVALIA, PRIMERA, TIIDA, INTERSTAR, PRIMASTAR 1.5DCI & 1.9 DCI SUZUKI: GRAND VITARA, JIMNY 1.5DDIS & 1.9DDIS
FERRAMENTAS OEM	MOT1489, MOT1430, MOT1054.
CÓDIGOS DE MOTOR	K9K, F8Q, F9Q - Gasolina, Clío, R19, Laguna 1.8/2.0 F3R F3P



53289

45,00€

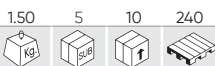

KIT DE BLOQUEIO RENAULT 1.4, 1.6, 1.8, 2.0 16V

MARCAS	<p>RENAULT: ESPACE/GRAND ESPACE (98-02), ESPACE/GRAND ESPACE IV (02-10), KANGOO/TREKKA (01-09), LAGUNA (98-01), LAGUNA II (01-07), LAGUNA III (07-13), MEGANE (99-03), MEGANE II (02-10), MEGANE III/SPORT (08-13), MEGANE/SCENIC (99-00), SCENIC/RX4 (99-03), SCENIC/GRAND SCENIC II (03-09), TRAFIC II (01-11), TWINGO II (08-14), VEL SATIS (00-10), WIND (10-14)</p> <p>DACIA: LOGAN/MCV (05-11).</p> <p>NISSAN: KUBISTAR X76 (03-09), PRIMASTAR (02-11).</p> <p>VAUXHALL/OPEL: JETTA, TOURAN, GOLF, GOLF PLUS, POLO, PASSAT, TIGUAN, SCIROCCO.</p>
FERRAMENTAS OEM	MOT1489 (1), MOT1054 (2), MOT1496 (3)
CÓDIGOS DE MOTOR	<p>1.4 16V K4J: 730, 732, 740.</p> <p>1.6 16V K4M: 752, 753, 760, 761, 764, 788, 812, 813, 854, 856.</p> <p>1.8 16V F4P: 720, 722, 760, 770, 771, 772, 773, 774, 775.</p> <p>2.0 16V F4R: 700, 701, 712, 713, 714, 715, 720, 722, 730, 732, 736, 738, 740, 741, 744, 746, 747, 762, 763, 764, 765, 766, 767, 770, 771, 780, 790, 791, 792, 820, 830, 832, 867.</p> <p>2.0 16V F4R(TT): 720, 722, 764, 765, 774, 776, 784, 786, 787, 794, 795, 796, 797, 800, 802, 810, 811, 870, 872, 874, 886, 887, 896, 897.</p>

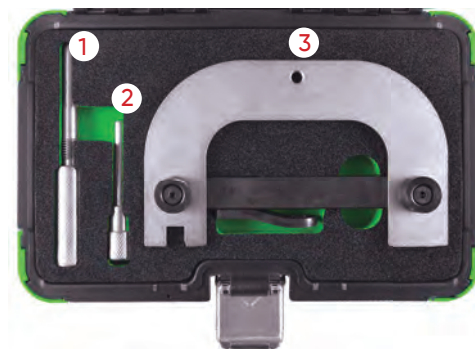

53290

51,00€

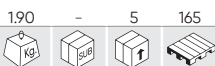

KIT DE BLOQUEIO RENAULT/VOLVO 16V, 20V

MARCAS	<p>RENAULT: LAGUNA 2.0 16V / 2.5 20V (1996-1999), SAFRANE 2.0 16V / 2.5 20V (1996-2001)</p> <p>VOLVO: 850 (1992-1997), C70 (1998-2002), S40 (1996-2004), V40 (1996-2004), S60 (2001-2005), S70 (1997-2000), S80 (1999-2005).</p>
FERRAMENTAS OEM	MOT1348 (1), MOT1337 (2), MOT1340 (3)
CÓDIGOS DE MOTOR	<p>RENAULT: N7Q 704/710/711(2.0 16V), N7U 700/701(2.5 20V).</p> <p>VOLVO: B4164S, B4164S2, B4184S, B4184S2, B4184S3, B4184S9, B4184S10, B4194T, BS194T2, B420S4, B4204S2, B4204T, B4204T2, B4204T3, B4204T5, B5202FS, B5204FT, B5204T2, B5204T3, B5204T4, B5204T5, B5234FS, B5204FT, B5234T3, B5234T4, B5234T5, B5234T6, B5234T7, B5234T8, B5234T9, B5244S, B5244S2, B5244SG, B5244SG2, B5244T, B5244T3, B5244T4, B5244T5, B5244T7.</p>

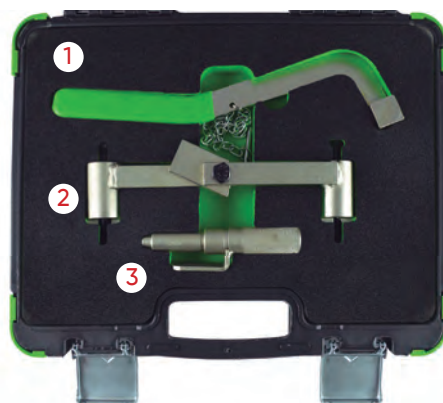

53291

68,00€



KIT DE BLOQUEIO RENAULT

MARCAS	RENAULT: CLIO, LAGUNA, MEGANE
FERRAMENTAS OEM	MOT1496 (1), MOT1489 (2), MOT861/1863 (3), MOT1490(4)
CÓDIGOS DE MOTOR	K4J, K4M, F4P, F4R.

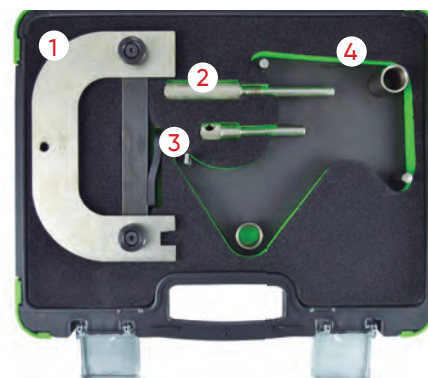

53292

116,00€

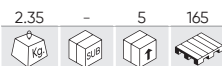

KIT DE BLOQUEIO RENAULT/OPEL 2.2, 2.5 TDI DCI

MARCAS	RENAULT: LAGUNA II, ESPACE, MASTER, TRAFIC, 2.2 / 2.5 DCI OPEL: VIVARO, MOVANO, DIESEL: 2.2 / 2.5 DTI, ASTRA B, VECTRA B, SIGNUM, ZAFIRA, 2.2 16V
FERRAMENTAS OEM	KM6205 (1), KM6204 (2), KM6077 (3)
CÓDIGOS DE MOTOR	2.2 / 2.5

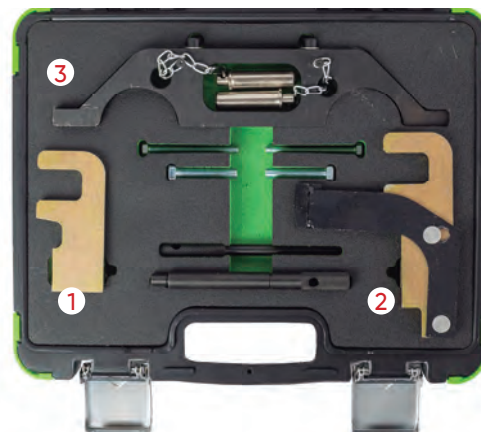

53311

97,00€

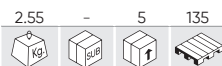

KIT DE BLOQUEIO RENAULT/NISSAN/OPEL/VAUXHALL 2.0, 2.3 DCI, CDTI, M9R, M9T

MARCAS	NISSAN: PRIMASTAR X83 (06-15), QASHQAI/QASHQAI+2 J10 (07-14), X-TRAIL T31 (07-14). VAUXHALL/OPEL: MOVANO-B (10-17), VIVARO (06-15). RENAULT: ESPACE/GRAND ESPACE IV (06-10), KOLEOS (08-15), LAGUNA LL (05-07), LAGUNA LLL (07-14), MASTER LLL (10-15), MEGANE LL (06-10), SCENIC/GRAND SCENIC LL (06-09), SCENIC/GRAND SCENIC LLL (09-15), TRAFIC LL (06-14), VEL SATIS (05-10)
FERRAMENTAS OEM	MOT1769 (1), EN-48334 (2), MOT1766 (3), EN-48330 (3), KM-6130 (4), EN-48332 (5), MOT1773 (6), EN-48831 (6)
CÓDIGOS DE MOTOR	2.0D DCI M9R: 630, 780, 782, 784, 786, 788, 830, 832, 833, 834, 835, 836, 838, 855, 856. 2.0D CDTI M9R: 630, 780, 782, 784, 786. 2.3 BI-CDTI: LP6/M9T706, LW7/M9T706. 2.3D DCI M9T: 670, 672, 676, 678, 680, 686, 690, 692, 694, 698.



53523

91,00€

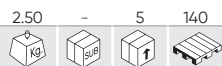

KIT DE BLOQUEIO DE MOTORES A DIESEL RENAULT/NISSAN/OPEL 1.6 DCI

MARCAS	RENAULT: ESPACE/GRAND ESPACE IV (06-10), KALEOS (08-11), LAGUNA LL (05-07), LAGUNA LLL (07-12), MASTER LLL (10-12), MAGANE LL (06-10), SCENIC/GRAND SCENIC LL (06-09), SCENIC/GRAND SCENIC LLL (09-12), TRAFIC LL (06-12), VEL SATIS (05-10) NISSAN: PRIMASTAR X83 (06-10), QASHQAI/QASHQAI+2 J10 (07-10), X-TRAIL T31 (07-12). VAUXHALL / OPEL: MOVANO-B (10-12), VIVARO (06-12).
FERRAMENTAS OEM	MOT1969 (1), MOT1970 (2), MOT1770, MOT1773, EN-48330, EN-48332, EN-48334, EN-48831, KM-6130
CÓDIGOS DE MOTOR	M9R 2.0DCI: 610, 615, 630, 700, 721, 740, 742, 760, 761, 762, 763, 780, 782, 784, 786, 788, 800, 802, 803, 805, 808, 816, 830, 832, 833. M9T 2.3DCI: 670, 672, 676, 678, 680, 686, 690, 692, 694, 698.



54210

84,00€

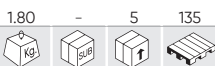

KIT DE BLOQUEIO DA ÁRVORE DE CAMES PARA RENAULT 1,8, 2,0 16 V

MARCAS	RENAULT LAGUNA II (2001 - 2009), MEGANE II (2002 - 2009), Scenic (2002 - 2009)
FERRAMENTAS OEM	MOT 1509-01 (1), 1509 (2)
CÓDIGOS DE MOTOR	700, 701, 712, 713, 714, 715, 720, 721, 722, 722, 730, 732, 736, 738, 740, 741, 744, 746, 747, 760, 761, 762, 763, 764, 765, 766, 767, 770, 771, 773, 774, 774, 775, 776, 784, 786, 787, 790, 792, 794, 797, 830, F4P, F4R



54225

133,00€

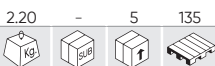

KIT DE BLOQUEIO DE VOLANTE / POLIA DA CAMBOTA PARA RENAULT/NISSAN

MARCAS	NISSAN: PRIMASTAR (06-15), QASHQAI/QASHQAI+2 (07-14), X-TRAIL (07-14), NAVARA (15-16), NV400 (11-16) RENAULT: ESPACE V (15-16), CLIO (06-16), FLUENCE (09-15), LAGUNA (05-15), LATITUDE (10-15), MEGANE (06-15), SCENIC/ GRAND SCENIC (06-15), ESPACE/GRAND ESPACE IV (02-15), KOLEOS (08-16), TRAFIC II (07-15), VEL SATIS (00-10), MASTER III (10-16)
FERRAMENTAS OEM	MOT 1431(1), MOT 1716(2), MOT 2019(2), MOT 1789(3), MOT 919-02(4)
CÓDIGOS DE MOTOR	1.4:H4 JT700 1.6:M5M400, M5M450 2.0:M4R700, M4R701, M4R704, M4R711, M4R713, M4R714, 2.0D:M9R726, M9R730, M9R735, M4R737, M9R740, M4R746, M9R742, M9R744, M9R746, M9R748, M4R750, M4R751, M4R752, M4R753, M4R754, M9R610, M9R613, M95615, M9R630, M9R750, M9R760, M9R761, M9R762, M9R762, M9R763, M9R700, M9R721, M9R722, M9R724, M9R756, M9R780, M9R782, M9R800, M9R802, M9R803, M9R804, M9R805, M9R806, M9R808, M9R809, M9R811, M9R812, M9R814, M9R815, M9R816, M9R817, M9R820, M9R824, M9R828, M9R830, M9R832, M9R833, M9R834, M9R835, M9R836, M9R838, M9R839, M9R844, M9R845, M9R846, M9R849, M9R854, M9R855, M9R856, M9R857, M9R858, M9R859, M9R865, M9R866, M9R784, M9R786, M9R788 2.3D:M9T670, M9T672, M9T676, M9T678, M9T680, M9T686, M9T690, M9T692, M9T694, M9T696, M9T698, M9T700, M9T702, M9T706, M9T708, M9T870, M9T880, M9T890, M9T896, M9T898, M9T899, YS23DDT, YS23DDTT 2.5:2TR700, 2TR702, 2TR703, 2TR704, 2TR705, 2ZV604, V4U604, VQ25 3.5:V4Y701, V4Y711, V4Y713, V4Y715



SEU CONJUNTO DE FERRAMENTAS DE CRONOMETRAGEM AINDA MAIS PRÓXIMO

INSIRA O CÓDIGO DA FERRAMENTA OEM OU O CÓDIGO DO MOTOR DO SEU CARRO EM SEU NAVEGADOR DA INTERNET E ENCONTRE UMA FERRAMENTA DE CRONOMETRAGEM COMPATÍVEL

54289

38,00€

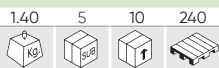

N

KIT DE BLOQUEIO DO VOLANTE DE INÉRCIA PARA MERCEDES/RENAULT/DACIA/NISSAN

MARCAS	DACIA DOKER 2015 + DACIA DUSTER 2015+ DACIA LODGY 2015+ DACIA LOGAN 2013/-2020 DACIA SANDERO 2013+ MERCEDES-BENZ A-CLASS 2018+ MERCEDES-BENZ B-CLASS 2019+ MERCEDES-BENZ CLA 2019+ MERCEDES-BENZ GLA 2019+ MERCEDES-BENZ GLB 2019+ RENAULT ARKANA 2019+ RENAULT CAPTUR 2018+ RENAULT CLIO V 2019 + RENAULT KADJAR 2018+ RENAULT MEGANE IV 2017+ RENAULT SCENIC/GRAND SCENIC IV 2018+ RENAULT TALISMAN 2018+
FERRAMENTAS OEM	MOT.2188 (1)
CÓDIGOS DE MOTOR	HR13DDT, H4Bt 400, H4Bt 408, H4Bt 410, H4Bt 411, H4M 730, H4M 738, H4M 740, H5H 450, H5H 470, H5H 480, 282.914



54438

40,00€



N

KIT DE BLOQUEIO RENAULT/NISSAN 3.0DCI

MARCAS	NISSAN: NAVARA PICK UP, PATHFINDER, INFITI RENAULT: LAGUNA, LATITUDE
FERRAMENTAS OEM	MOT 1880 (1) MOT 1970 (2) MOT 1874 (3)
CÓDIGOS DE MOTOR	V9X, V9X 791, 891

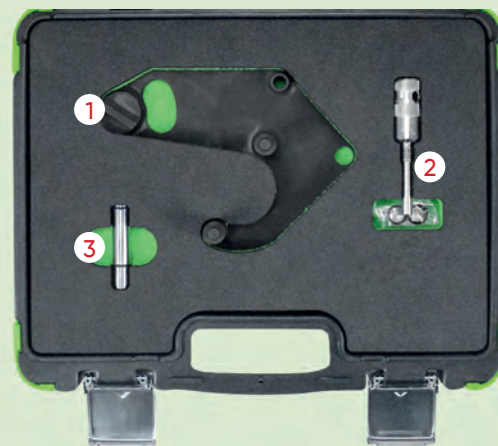

54439

32,50€

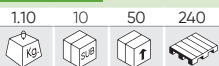

N

BLOQUEIO DA POLIA DA EIXO DE MANIVELAS RENAULT/DACIA 0.9, 1.0, 1.2, 1.6 TCE

MARCAS	DACIA DOKKER 2012 - 2019, PLUMERO 2013 - 2018, LOGIA 2012 - 2018 RENAULT CAPTURAR 2013 - 2019, CLIO IV 2012 - 2019, KADJAR 2015 - 2018, KANGOO II 2013 - EN, MEGANE III 2012 - 2017, MEGANE IV 2016 - 2020, ESCENICO/GRAN ESCENICO III 2012 - 2017, ESCENICO/GRAN ESCENICO IV 2016 - 2018, TWIN-GO III 2014 - EN
FERRAMENTAS OEM	MOT. 2006 (1) MOT. 2054 (1) 281589004000 (1)
CÓDIGOS DE MOTOR	0.9TCE: H4B 453, H4Bt 400, 401, 408, 410, 411, 451. 1.0TCE: H4D, H4D 400, 450, 460, 470 1.2TCE: H5Ft 400, 403, 404, 405, 408, 410, 412. 1.6TCE: H4M 429, 438, 440, 729, 730, 738, 740, 748, 749

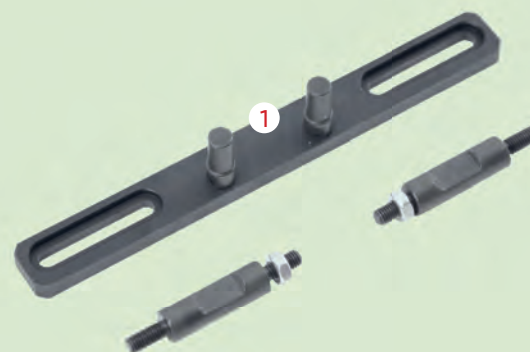

53299

291,00€

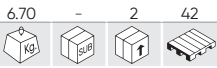

KIT DE BLOQUEIO OPEL/VAUXHALL

MARCAS	OPEL / VAUXHALL
FERRAMENTAS OEM	EN-46788 (1), KM927 (2), EN-46789 (3), KM929 (4), EN-46785 (5), EN-46788 (6), 1 860 985 000 (7), KM932 (8), KM933 (9), EN-49978 (10), KM933 (11)
CÓDIGOS DE MOTOR	1.3 CDTI 16V, 1.9 CDTI, 2.0 DTI, 2.2 DTI.



53300

41,00€

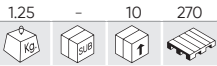

KIT DE BLOQUEIO OPEL/VAUXHALL/CHEVROLET 2,0CDI

MARCAS	OPEL VAUXHALL CHEVROLET
FERRAMENTAS OEM	EN-48245 (1), EN-48246 (2), 205083060 (3) (4) (5) (6)
CÓDIGOS DE MOTOR	OPEL / VAUXHALL: Z20DM, Z20DMH CHEVROLET: LLWZ20DMH, RA 420 , Z20SI, Z 20S3, Z 20S4, Z 20S5

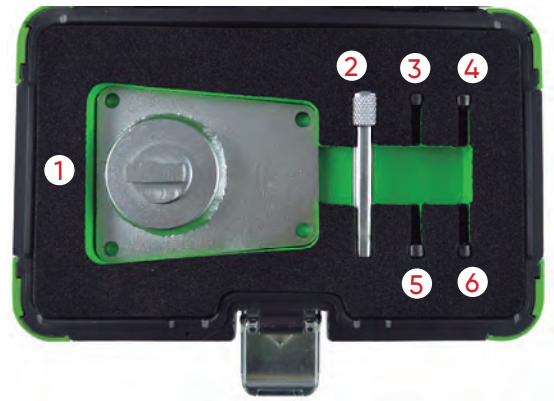

53301

44,00€

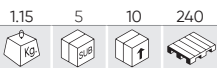

KIT DE BLOQUEIO SUZUKI/OPEL 1.0, 1.2, 1.4

MARCAS	SUZUKI: WAGON R (05-08). VAUXHALL / OPEL: AGILA (00-08), ASTRA-G (98-06), ASTRA G CLASSIC II (03-10), ASTRA-H (04-11), COMBO (04-12), CORSA-B (97-00), CORSA-C (00-07), CORSA-D (06-12), MERIVA-A (04-10), TIGRA-B (04-10).
FERRAMENTAS OEM	KM-953/09919-58310 (1), KM-952/09912-38310 (2), KM-954/09919-08310 (3), KM-6130 (4), KM-955/09919-58320 (5)
CÓDIGOS DE MOTOR	1.0 12V: X10XE, Z10XE, Z10XEP. 1.2 16V: X12XE, Z12XE, Z12XEP. 1.4 16V/ECOFLEX: Z14XEL, Z14XEP.

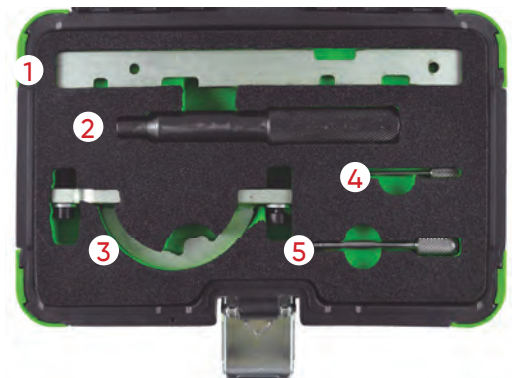

53302

44,00€

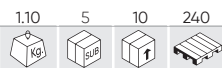

KIT DE BLOQUEIO FIAT/ALFA ROMEO/VAUXHALL/OPEL/SAAB JTD

MARCAS	SAAB: 9-3 (04-08), 9-5 (05-08). VAUXHALL / OPEL: ASTRA-H, VECTRA-C, SIGNUM (04-07), ZAFIRA-B (05-07).
FERRAMENTAS OEM	EN46789/32 025 008 (1) (3), EN46788/32 025 009 (2), KM6349 (4)
CÓDIGOS DE MOTOR	Z19DT, Z19DTH, Z19DTL.



53305

136,00€

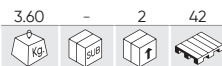

KIT DE BLOQUEIO SAAB/OPEL/VAUXHALL

MARCAS	VAUXHALL / OPEL: ANTARA (06-10), CALIBRA (93-98), CAVALIER/VECTRA-A (93-95), OMEGA-B (94-03), SIGNUM (03-05), SINTRA (96-99), VECTRA-B (95-02), VECTRA-C (02-05). SAAB: 900 (93-98), 9000 (95-97), 9-5 (98-03)
FERRAMENTAS OEM	KM-800-1 (1), KM-800-2 (2), KM-800-20 (3), KM-800-10 (4), 83 95 006 (5), KM-800-30 (6), MKM-6038, 83 95 006 (7)
CÓDIGOS DE MOTOR	2.5 V6: SAAB: B2581, VAUXHALL/OPEL: C25XE, X25XE. 2.6 V6: VAUXHALL/OPEL: Y26SE. 3.0 V6: SAAB: B308E, B308I, VAUXHALL / OPEL: X30XE. 3.2 V6: VAUXHALL/OPEL: Y32SE, .



53307

38,50€

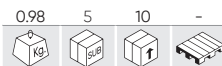

KIT DE BLOQUEIO ALFA/OPEL/VAUXHALL 1.6, 1.8 16V

MARCAS	OPEL / VAUXHALL: CORSA-D, AGILA, ASTRA-G-H, MERIVA, ZAFIRA-B, VECTRA-C, SIGNUM, INSIGNA	1.6, 1.8
	CHEVROLET: AVEO, CRUZE, ORLANDO	1.4, 1.6, 1.8
	ALFA ROMEO: 159 FIAT: CROMA	1.8
FERRAMENTAS OEM	E10290 (1), 23056-06 (2) (3), E10230 (4), 23164-04 (5), 23174-01 (6), 23056-05 (7)	
CÓDIGOS DE MOTOR	OPEL / VAUXHALL: Z16LEL, Z16LER, Z16LET, Z16XE1, Z16XEP, Z16XER, A16XER, 18XER, A18XER, 2HO/A18XEL. CHEVROLET: G14D, LDD, LXV (F16D4), 2HO(Z18XER). ALFA / FIAT: 939A4.000.	

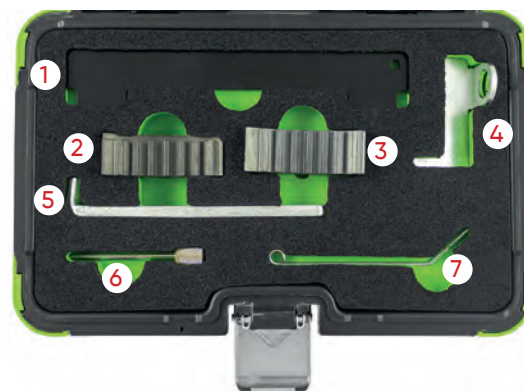

53316

34,00€

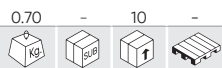

KIT DE BLOQUEIO FIAT/OPEL/VAUXHALL 2.2 16V CADEIA

MARCAS	OPEL: ASTRA-G (2000-2006), ASTRA-H (2006-2011), SIGNUM (2003-2008), VECTRA-B (2000-2002, VECTRA-C (2002-2008), ZAFIRA-A (2000-2005), ZAFIRA-B (2005-2012), SPEEDSTER (2000-2006). VAUXHALL: VX220 (2000-2006). FIAT: CROMA (2005-2009).
FERRAMENTAS OEM	VAUXHALL / OPEL: Z22SE, Z22YH FIAT: 194A1.000.



53317

34,00€

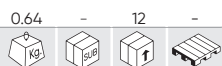

BLOQUEADOR DA BOMBA ANTICONGELANTE OPEL/VAUXHALL 2.2

MARCAS	OPEL 2.2 Corrente VAUXHALL 2.2 Corrente
--------	--



53452

26,50€



KIT DE BLOQUEIO OPEL/FORD/FIAT/ ALFA ROMEO/LANCIA/SUZUKI

MARCAS	VAUXHALL/OPEL 1.3 CDTI: AGILA, CORSA, COMBO (03-08), ASTRA-H(05-08), MERIVA, TIGRA-B(04-08) SUZUKI 1.3 DDIS: IGNIS, WAGON R(03-08), SWIFT(04-08) FORD: 1.3 TDCI FIAT/ALFA ROMEO/LANCIA: 1.3 JTD MULTIJET
FERRAMENTAS OEM	104-A EN 46781 (1) , EN 46785 (2)

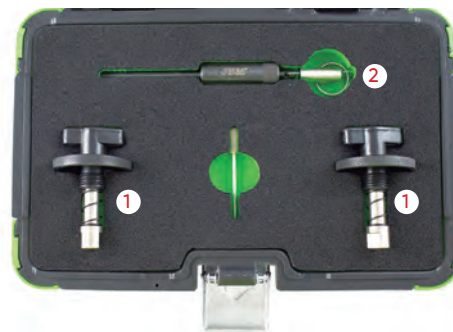

53651

91,00€



KIT DE BLOQUEIO AUDI OPEL/VAUXHALL 1.0, 1.2, 1.4 TURBO

MARCAS	OPEL: ADAM, AMPERA, ASTRA-J, AVEO, CORSA-D, INSIGNIA, MERIVA-B, MOKKA, ZAFIRA-C TOURER
FERRAMENTAS OEM	EN 49977-100 (1), EN 49977-200 (2), EN 49978 (3), KM 952 (4), KM 953-A (5), KM 955-1 (6), KM 955-2 (7).
CÓDIGOS DE MOTOR	1.0: A10XEP (LDB) 1.2: A12XEL (LWD), A12XER (LDC) 1.4: A14XEL (L2Z), A14XER (LDD), LDU A14NEL (LUH), A14NET (LUJ), TWINPORT / ECOFLEX ENGINES A14XFL (LUU), A14NEL (LDD), A14NEL (LUJ), A12XEL (L2Q)



54205

49,00€

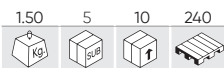

KIT DE BLOQUEIO DE DISTRIBUIÇÃO PARA VAUXHALL/OPEL 1.6 CDTI

MARCAS	VAUXHALL/OPEL: Astra J (13-18), Astra K, (15-19), GTC (15-18), Insignia A (15-17), Insignia- B (17-20), Meriva B (13-17), Mokka (14-16), Mokka X (16-20), Zafira C Tourer (13-19).
FERRAMENTAS OEM	EN-6349, EN-6130 (1), EN-51143 (2), EN-51140 (3), EN-50513 (4), EN-51188 (5)
CÓDIGOS DE MOTOR	B16DTC, B16DTE, B16DTH, B16DTJ, B16DTL, B16DTN, B16DTR and B16DTU. D16DTH, D16DTI, D16DTJ, D16DTN, D16DTR, D16DTU

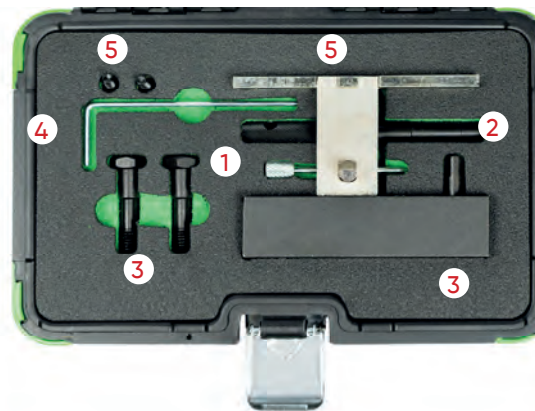

54214

96,00€



KIT DE BLOQUEIO DE DISTRIBUIÇÃO PARA OPEL/ISUZU 1.6D, 1.7D

MARCAS	ASTRA, CAVALIES, VECTRA-A(87-00), ISUZU, NOVA, CORSA / COMBO, STRA, CAVALIER, VECTRA, FRONTERA, MONTEREY, MIDI, BRAVA (88-04)
FERRAMENTAS OEM	VAS 6079 (1), KM 951 (2), KM 851 (3), 23-029 (4), KM 661-2 (5), KM 661 (6)
CÓDIGOS DE MOTOR	OPEL : 16DA, 17D, 17DR, X17DTL ISUZU : 4EC1, 4EE1, 4JB1, 4XJ1, 4JA1, 4JG1, 4FC1, 4FD1, 4FG1, Z17DT, Y17DT/DTL

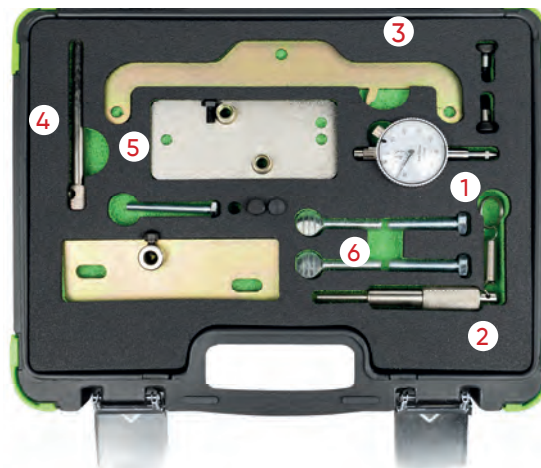

54217

104,00€



KIT DE BLOQUEIO DE DISTRIBUIÇÃO PARA VAUXHALL/OPEL/SAAB 2.0, 2.2 DTI

MARCAS	VAUXHALL/OPEL: ASTRA-G (98-06), FRONTERA-B (98-04), OMEGA-B, (98-03), SIGNUM (03-05), SINTRA (98-99), VECTRA-B (97-02), VECTRA-C (02-05), ZAFIRA-A (99-05), SAAB: 9-3 (98-04), 9-5 (02-06)
FERRAMENTAS OEM	SAAB: 83 95 394 (1), 83 95 337 (2), 83 95 352 (3), 83 95 386 (4) VAUXHALL/OPEL/SAAB: KM-927 (2), KM-929 (3), KM-932 (4), KM-933 (1)
CÓDIGOS DE MOTOR	OPEL: X20DTH, X20DTL, Y20DTH, Y20DTL, X22DYH, Y22DTH, Y22DTR SAAB: D223L



54221

111,00€



KIT DE BLOQUEIO DE DISTRIBUIÇÃO PARA VAUXHALL/OPEL 1.3 CDTI

MARCAS	VAUXHALL/ OPEL 1.3 CDTI Corsa E Diesel Engine From 2015
FERRAMENTAS OEM	KM-662-C (1), EN-50515 (2), EN-51500 (3), EN-46775 (4), KM-955-1 (5), EN-46785 (6)
CÓDIGOS DE MOTOR	LKU B13DTE, LKU B13DTR



54434

48,50€



KIT DE BLOQUEIO OPEL 1.0, 1.4

MARCAS	VAUXHALL/OPEL ADAM 2014 - 2019, ASTRA-K 2015 - 2019, CORSA-E 2015 - 2019, INSIGNIA-B 2017 - 2020, MOKKA X 2016 - 2019, VIVA (KARL) 2015 - 2020
FERRAMENTAS OEM	EN-51367 (1) EN-51298 (2) EN-51632 (3)
CÓDIGOS DE MOTOR	1.0 L5Q/B10XE, L5Q/D10XE, LE1/B10XFL, LE1/B10XFT, LE1/B10XFL, LE1/D10XFL, LE1/D10XFT, LE1/F10XFL, LE1/F10XFT, LWT/B10XL 1.4 LE2/B14XFL, LE2/B14XFT, LE2/D14XFL, LE2/D14XFT, LFE/B14XNT, LFE/D14XNT, LV7/B14XE 1.5 LFV/B15XHT, LFV/D15XHL, LFV/D15XHT

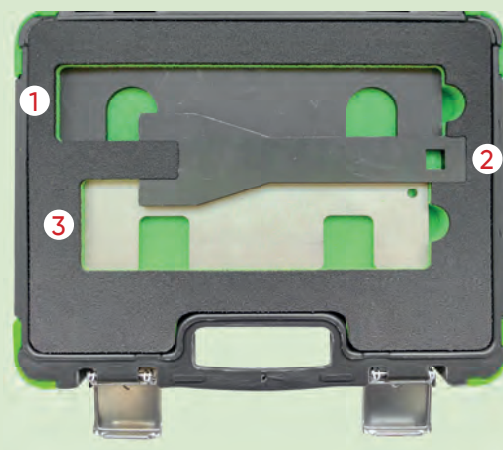

54435

14,50€



KIT DE BLOQUEIO OPEL/CHEVROLET/SAAB 1.4, 1.6, 1.8 ECOTEC

MARCAS	CHEVROLET: LACETTI (2005-2010), NUBIRA (2005-2010) OPEL/VAUXHALL: ASTRA-G (1998-2004), ASTRA-H (2004-2007), COMBO-C (2005-2012), CORSA-C (2000-2007), MERIVA-A (2003-2010), SIGNUM (2003-2007), TIGRA-B (2004-2010) VECTRA-B (1995-2002), VECTRA-C (2002-2008), ZAFIRA-A (1999-2005), ZAFIRA-B (2006-2013) SAAB: 9-3 (2003-2010)
FERRAMENTAS OEM	KM-911 (1) KM-6130 (2) KM-852 (3), EN-852 (3)
CÓDIGOS DE MOTOR	1.4: X14XE, Z14XE 1.6: X16SEJ, X16XEL, Y16XE, Z16XE, Z16YNG 1.8: F18D3 1.8: X18XE1, Z18XE, Z18XEL, X18E1 1.8: Z18XE

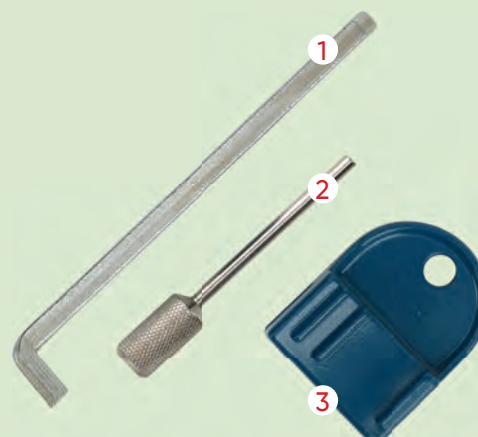

54436

124,00€



N

KIT DE BLOQUEIO OPEL 1.6 SIDI

MARCAS	VAUXHALL ASTRA-J 2013 - 2017,ASTRA-K 2015 - 2019,CASCADA 2013 - 2019,GTC 2015 - 2019,INSIGNIA 2013 - 2017,INSIGNIA-B 2018 - 2020,ZAFIRA-C TOURER 2014 - 2019
FERRAMENTAS OEM	EN 51153 (1) EN 50513 (2) EN 51148 (3) EN 51147 (4)
CÓDIGOS DE MOTOR	1,6 LWC/A16SHT LVP/A16XHT LWC/B16SHL LWC/B16SHT LVP/B16XHT LWC/D16SHJ LWC/D16SHL LWC/D16SHT

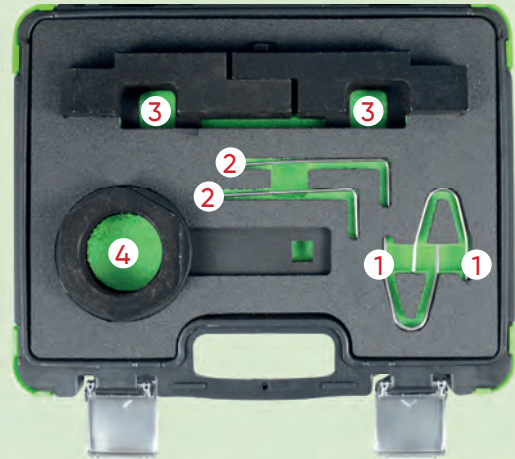

54437

110,00€

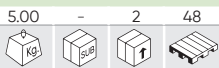

N

KIT DE BLOQUEIO OPEL/CHEVROLET/SAAB 2.0, 2.4

MARCAS	CHEVROLET CAPTIVA 2011 - 2015,HHR 2008 - 2009, MALIBU 2012 - 2015 SAAB 9-3 (02-12) 2010 - 2012,9-5 (10-12) 2010 - 2012 VAUXHALL/OPEL ANTARA 2011 - 2016,ASTRA-J 2012 - 2017,GTC (15-19) 2015 - 2019,INSIGNIA-A (08-17) 2008 - 2013
FERRAMENTAS OEM	EN-48585 (1) EN 43653 (2), J 43653 (2) EN 955 10 (3), KM 955 (3) EN-955-20 (4), KM 955-20 (4) EN 45027 1 (5), J 45027 1 (5) EN 45027 (6), EN45027 2 (6), J 45027 2 (6) EN 49212 (7), EN 49212 1 (7) EN 49212 (8), EN 49212 2 (8) EN 48953 (9)
CÓDIGOS DE MOTOR	LHU/A20NFT 2,0: LDK/A20NHT 2,0: LDK/A20NHT, LHU/A20NET, LHU/A20NFT, LHU/B20NFT 2,4: A24XE (LE5), A24XF (LE9) 2,4: LE5,LE9

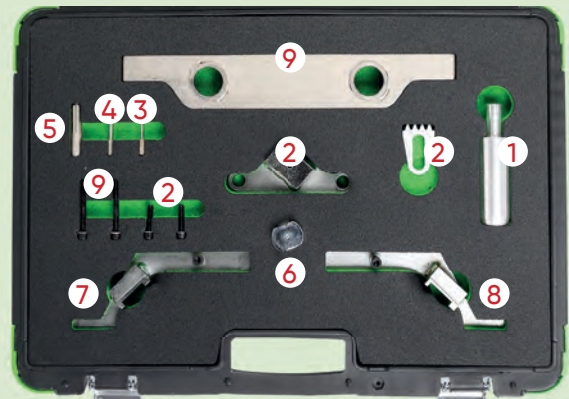

52271

18,00€

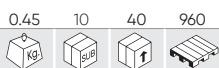

KIT DE BLOQUEIO DE DISTRIBUIÇÃO VAG

MARCAS	AUDI: A2 1.4TDI (02-06), A3 1.9, 2.0TDI (02-08), A4 1.6TDI (02-05), A4 1.9, 2.0TDI (04-08), A6 1.9TDI (02-05). SEAT: ALTEA 1.9SDI/TDI (05-08), LEON 1.9,2.0TDI (05-08), TOLEDO 1.9SDI/TDI (05-08). SKODA: FABIA 1.4TDI (03-06), OCTAVIA II 2.0TDI (03-06) VW :BEETLE 1.9TDI (02-08), BORA 1.9TDI (02-08), FOX 1.4TDI (02-08), GOLF 1.9, 2.0TDI (02-08), LUPO 1.4TDI (02-08), POLO 1.4, 1.9TDI (02-08), SHARAN 1.9TDI (02-08).
FERRAMENTAS OEM	AUDI: AMF, ASZ, ATD, AVB, AVF, AWX, AXR, AZV, BHC, BKC, BKD, BKE, BLB, BMN, BNA, BPW, BRB, BR, BRD, BRE, BRF, BUY, BVA, BVF, BVG. SEAT: BJB, BKC, BLS, BMM, BXE SKODA: AMF, AZV, BKD VW: AJM, AMF, ANU, ARL, ASZ, ATD, AUJ, AVB, AVF, AWX, AXR, BAY, BMS, BNM, BNV, BWB



51489

12,00€

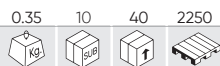

KIT DE BLOQUEIO DE ÁRVORE DE CAMES VAG 1.4, 1.6

MARCAS	VW: LUPO 99 , POLO 95, CADDY 96, POLO CLASSIC, VARIANT 96, BEETLE 1.4L 99, GOLF 1.4L, 1.6L 98 Y 1.4L, BORA, 1.6L 99. AUDI: A2.
FERRAMENTAS OEM	T10016
CÓDIGOS DE MOTOR	1.4 / 1.6 16V



53274

30,50€



KIT DE BLOQUEIO VOLKSWAGEN/SEAT/SKODA 1,2L

MARCAS	VOLKSWAGEN 1.2: LUPO / POLO / EOS / FOX. SEAT 1.2: IBIZA / CORDOBA SKODA 1.2: FABIA
FERRAMENTAS OEM	T10123 (1) (2), T10120 (3), T10121 (4)
CÓDIGOS DE MOTOR	AWY / BMD / AZQ / BME.



53275

35,50€

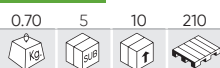

KIT DE BLOQUEIO VW-AUDI

MARCAS	DODGE: CALIBER (06-11) FORD: GALAXY (02-06) MITSUBISHI: GRANDIS (05-10), LANCER (05-10), OUTLANDER (07-10). SEAT: ALHAMBRA (00-15), ALTEA/ALTEA XL (04-15), CORDOBA (02-09), IBIZA (02-15), LEON (00-13), TOLEDO (04-11). SKODA: FABIA (00-14), FABIA II (07-15), OCTAVIA (00-10), OCTAVIA II (04-15), PRACTIK (10-15), RAPID (11-15), ROOMSTER (07-15), SUPERB (02-08), SUPERB II (08-15), YETI (09-14). AUDI: A1 (10-15), A2 (00-06), A3 (01-13), A4/ALLROAD (01-16), A5 (08-15), A6 (11-14), TT (08-14), Q3 (11-15), Q5 (08-15), A6 (10-14). VOLKSWAGEN: AMAROK (10-16), BEETLE (02-15), BORA (02-08), CADDY/MAXI (03-15), EOS (06-15), FOX (05-11), GOLF (02-15), GOLF PLUS (05-14), JETTA (05-15), LUPO (02-05), PASSAT/CC (02-15), POLO (99-14), SCIROCCO (08-14), SHARAN (02-15), TIGUAN (07-15), TOURAN (03-15), TRANSPORTER (03-17).
FERRAMENTAS OEM	DODGE: 9882, 9883. FORD: 310-085/23-059, 303-1054. MITSUBISHI: MB995206, MB995208, MB995209. VAG: T10100 (4), T10050 (1), 3359 (3/6)/T20102, T10115 (3), T10060A (2)/T40098, T20167.
CÓDIGOS DE MOTOR	1.2D TDi CR: CFWA. 1.4D TDi PD: AMF, BAY, BMS, BNM, BNV, BWB. 1.6D TDi CR: CAYA, CAYB, CAYC, CAYD, CAYE, CLNA. 1.9D TDi PD: AJM, ANU, ARL, ASZ, ATD, AUY, AVB, AVF, AVQ, AWX, AXB, AXC, AXR, BJB, BKC, BLS, BLT, BMT, BPZ, BRM, BRR, BRS, BRU, BSU, BSV, BSW, BTB, BVK, BXE, BXF, BXJ. 2.0D TDi CR/TDi PD: AZV, BDJ, BDK, BEW, BGW, BHW, BKD, BKP, BKQ, BLB, BMA, BMM, BMN, BMP, BMR, BNA, BPW, BRA, BRC, BRD, BRE, BRF, BRT, BSS, BST, BSY, BUJ, BUZ, BVA, BVE, BVF, BVG, BVH, BWC, BWV, CAA, CAAB, CAAC, CAAD, CAE, CAG, CAGB, CAGC, CAHA, CAHB, CBAA, CBAB, CBAC, CBBA, CBBB, CBDA, CBDB, CBDC, CBÉA, CCHA, CCHB, CDBA, CDCA, CEGA, CFCA, CFFA, CFFB, CFFD, CFFE, CFGB, CFGC, CFHA, CFHB, CFHC, CFHD, CFHE, CFHF, CFJA, CGLA, CGLB, CGLC, CGLD, CJAA, CJCA, CJC, CJC, CJC, CLCA, CLCB, CLJA, CLLA, CNEA, ECD, ECD/BSY, ECD/BYL, ECE/BWD.

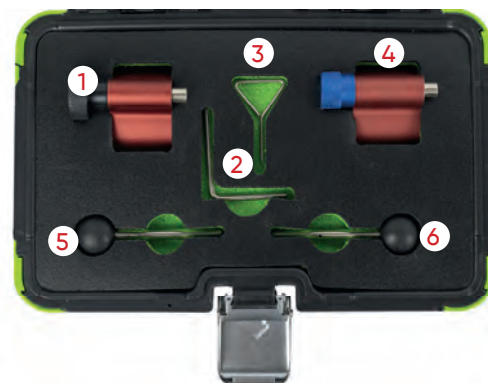

53276

160,00€

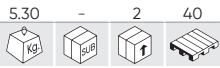

KIT DE BLOQUEIO AUDI SKODA

MARCAS	MOTOR AUDI, VW: V6 2.0, 2.8, 3.0T FSI. AUDI QS: 2.0, A6L 2.8, 3.0T.
FERRAMENTAS OEM	3418 (1), 3458 (2), T10100 (3), T10123 (4), T10121 (5), 3242 (6), 3551 (8), T10020 (9), T10098 (10), 3078 (12), 2064 (13), 3369 (14), T10092 (15), T40011 (17), 2065A (18), T10016 (19), 3359 (20), T10008 (21), T10050 (22) T10265 (23), T10264 (24), T10060A (25), T10120 (27), 3366 (28)
CÓDIGOS DE MOTOR	2.0, 2.8, 3.0

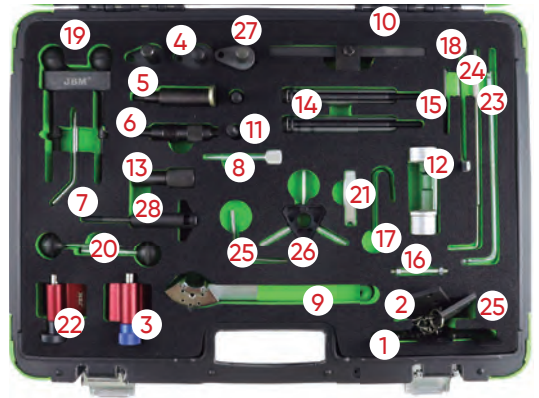

53277

45,00€

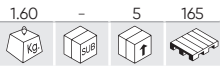

KIT DE FERRAMENTAS PARA CORREIA DE DISTRIBUIÇÃO VW/AUDI

MARCAS	GASOLINA	AUDI: 80, 100, A3, A4, A6 1.6, 1.8/TURBO, 2.0, 2.0 16V, A3, A4 1.6 (96-). SEAT: IBIZA/CORDOBA, TOLEDO, ALHAMBRA, INCA 1.6, 1.8, 1.8 16V, 2.0, 2.0 16V, IBIZA/ CORDOBA, LEON, TOLEDO 1.6 (99-), ALHAMBRA 2.0 (00-). VOLKSWAGEN: POLO CLASSIC, SCIROCCO, CORRADO, GOLF, JETTA, VENTO, PASSAT, SHARAN, TRANSPORTER 1.6, 1.8/TURBO, 1.8 16V, 2.0, 2.0 16V, POLO CLASSIC, GOLF, BORA, BEETLE 1.6 (97-), 2.0 (99-). SKODA: OCTAVIA 1.6 (97-), 2.0 (99-).
	DIESEL	AUDI: 80, 100, A3, A4, A6 1.9 TURBO D, 1.9TDI, 2.5TDI, A3, A4, A6 2.0TDI, A2, A3, A4, A6 1.2TDI, 1.4TDI, 1.9TDI (99-). SEAT: IBIZA/CORDOBA, LEON, TOLEDO, ALHAMBRA, INCA 1.7SDI, 1.9D/TD /SDI/TDI. EQRD: GALAXY (02-06). SKODA: FELICIA, OCTAVIA 1.9D/TDI. VW: POLO, POLO CLASSIC, GOLF, JETTA, VENTO, BORA, BEETLE, PASSAT, SHARAN, CADDY, TRANSPORTER 1.5D, 1.6D/ TURBO, 1.7D/SDI, 1.9SDI/TDI, GOLF, PASSAT 2.0TDI.
FERRAMENTAS OEM	T10020 (1), 3387 (2), V159 (3), T10060/T100604 (4), T10115 (5), T40011 (6)	
CÓDIGOS DE MOTOR	2.0, 2.8, 3.0	



53278

143,00€

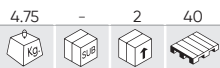

KIT DE BLOQUEIO AUDI 2.8, 3.2 FSI, 3.0 TFSI

MARCAS	A2, A4, A4 QUATTRO, A6 (2004-2007) A2, A3, A4, A3 FSI (2004-2007) A4, A6, A8 3.2 FSI A6 L QUATTRO 2.4 A6 2.4, A6 2.4 QUATTRO (2004-2007) A4 3.2 FSI (2004-2007) A6 3.2 FSI (2004-2007) A8 3.2 FSI (2005-2007)
FERRAMENTAS OEM	T10172 (1), 3212 (2), T40070 (3), T40069 (4), T40071 (5), T10172/2 (6)
CÓDIGOS DE MOTOR	AUK / BDW / BDX / BKH / CAJA / CALA



53279

97,00€

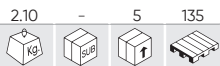

KIT DE BLOQUEIO VW/AUDI 1.8, 2.0, TSI, TFSI

MARCAS	AUDI: A3 (96-09), A4 (94-09), A6 (95-11), S3 (99-13), TT (98-14). SEAT: ALHAMBRA (97-10), ALTEA/ALTEA XL (06-09), CORDOBA (99-02), EXEO (09-10), IBIZA (99-02), LEON (99-13), TOLEDO (99-09). SKODA: OCTAVIA/OCTAVIA TOUR (98-10), OCTAVIA II (04-09). VOLKSWAGEN: BEETLE (99-11), BORA (97-04), EOS (06-10), GOLF (97-12), GOLF PLUS (05-09), JETTA (05-09), PASSAT (96-10), SCIROCCO (09-14), SHARAN (97-10), TOURAN (03-09).
FERRAMENTAS OEM	T10020 (1), T10252 (2), T10092 (3), T10115 (4), T40011 (4), 3366 (5), T10060 (6)
CÓDIGOS DE MOTOR	1.8: ADR, AFY, AGN, AJP, APG, APT, AQE, ARG, ARH, AVV. 1.8T: AEB, AGU, AJH, AJL, AJQ, AMK, AMU, ANB, APP, APU, APX, APY, AQA, AQX, ARX, ARY, ARZ, AUM, AUQ, AVC, AWC, AWT, AWU, AYP, BAM, BFV, BVP, BVR. 2.0 TSI: AXW, BHD, BLR, BLX, BLY, BMB, BVX, BVY, BVZ. 2.0 TFSI/S/R/TSI: AXX, BPY, BWA, BGB, BPG, BPJ, BUL, BWE, BWT, BYK, BHZ, BZC, BWJ, BYD, CDLA, CDLB, CDLC, CDLD, CDLF, CDMA.



53280

112,00€

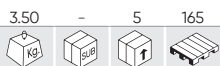

KIT DE ALINHAMENTO EIXO DE COMANDO VW/AUDI 3.0 V6

MARCAS	AUDI: A4 (01-08), A6 (01-08), A8 (03-10).
FERRAMENTAS OEM	3387 (1), T40030 (2) (4), T40026 (3), T40028 (5)
CÓDIGOS DE MOTOR	3.0 V6 30V: ASN, AVK, BBJ, BGN.

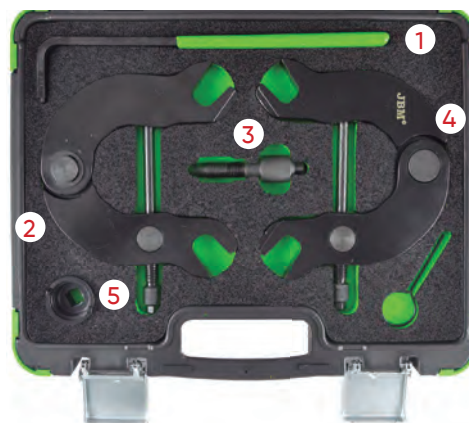

53281

55,00€



KIT DE ALINHAMENTO EIXO DE COMANDO VW/AUDI

MARCAS	VOLKSWAGEN: 2.5 TDi V6 AUDI: A4, A6, A8
FERRAMENTAS OEM	3369 (1), 3242 (2), 3458 (3)
CÓDIGOS DE MOTOR	AFB/AKN



53282

48,00€

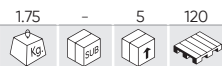

KIT DE BLOQUEIO VAG 1.2, 1.4, 1.6

MARCAS	SEAT: ALHAMBRA (10-15), ALTEA/ALTEA XL (08-15), IBIZA/ CORDOBA (08-12), LEON (07-13), TOLEDO (07-15). VOLKSWAGEN: BEETLE (11-15), CADDY/CADDY MAXI (10-15), EOS (06-12), GOLF (03-12), GOLF PLUS (03-14), GOLF V ESTATE (07-13), GOLF VI CABRIOLET (10-15), JETTA (06-14), PASSAT (05-11), POLO (02-14), SCIROCCO (08-12), TIGUAN (07-12), TOURAN (03-15). SKODA: FABIA II (07-15), OCTAVIA II (04-15), PRAKTIK (10-15), RAPID (12-15), ROOMSTER (06-15), SUPERB II (09-14), YETI (09-14). AUDI: A1 (10-15), A3 (03-13).
FERRAMENTAS OEM	T10171 (1), T10170 (2), T40011 (3)
CÓDIGOS DE MOTOR	1.2 TFSI: CBZA, CBZB, CBZC. 1.4 FSI: AXU, BKG, BLN. 1.4 TFSI: BLG, BMY, BWK, CAVA, CAVB, CAVC, CAVD, CAVE, CAVF, CAXA, CAXC, CDGA, CSMA. 1.6 FSI: BAG, BLF, BLP, BTS.



53283

92,00€



KIT DE BLOQUEIO GRUPO VAG 2.7, 3.0 TDI

MARCAS	VOLKSWAGEN: TOUAREG, PHATEON VAG: DIESEL 2.7 / 3.0 V6 AUDI: A4, A5, A6
FERRAMENTAS OEM	3242 (1), T40060 (2) (3), 3359 (4), T40058 (5), T40061 (6), T40062 (7), T40049 (8)
CÓDIGOS DE MOTOR	ASB, BKN, BKS, BWZ, BNG, BPP, BSG, BUG, BUN, CAWA, CAMB, CANA, CANB, CANC, CAND, CAPA, CARA, CARS, CASA, CASE, CASC, CAM, CC/HA, CCWA, CCWB, CDYA, CDVB, CDVC, CEXA, CGKA, CGKB.

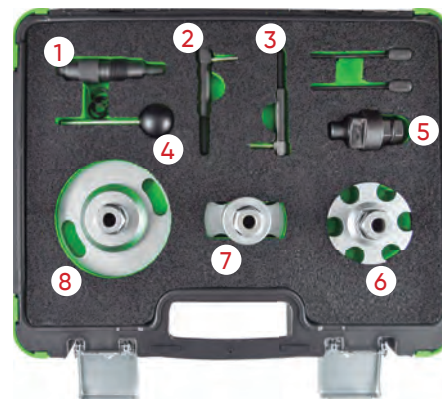

53284

306,00€



KIT DE BLOQUEIO GRUPO VAG 2.5 TDI

MARCAS	VOLKSWAGEN: TOUAREG (03-10), TRANSPORTER (03-09).
FERRAMENTAS OEM	T10225 (1), T10199 (2), T10234 (3), T10226 (4), T10193 (5), T10194 (6), T10199/01 (7), T10226 (8)
CÓDIGOS DE MOTOR	2.5D TDI PD: AXD, AXE, BAC, BLJ, BLK, BNZ, BPC, BPD, BPE.

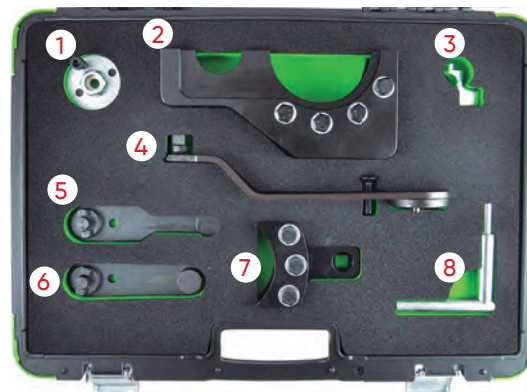

53285

56,00€

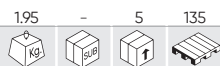

KIT DE BLOQUEIO VAG 2.4, 2.5, SDI, TDI

MARCAS	VOLKSWAGEN: CRAFTER (06-13), LT (96-06), TRANSPORTER (90-03).
FERRAMENTAS OEM	2065A (1), T50009 (2), T10025 (3), 3248/3419 (4), 2064 (5), 3355 (6)
CÓDIGOS DE MOTOR	2.4D: AAB, AJA. 2.5D SDI: AGX. 2.5D TDI: ACV, AHD, AHY, AJT, ANJ, APA, AUF, AVR, AXG, AXL, AYC, AYY, BBE, BBF. 2.5D TDI CR: BJJ, BJK, BJL, BJM.



53286

87,00€



KIT DE BLOQUEIO VAG 1.8, 2.0 TSI, TFSI

MARCAS	VOLKSWAGEN: 1.8 / 2.0 TSI / TFSI.
FERRAMENTAS OEM	T10368 (2), T10354 (3), T40271 (1)(4), T10352/2 (5), T10352/1 (6), T10352 (7), T40196 (8) (9) (10) (11), T40267(12) (13), T40098 (14), T10060A (15), T40011 (15)
CÓDIGOS DE MOTOR	BYT, BZB, CABA, CABB, CABD, CADA, CAEA, CAEB, CAWA, CAWB, CBFA, CCTA, CCZA, CCZB, CCZC, CDA, CDAB, CDHA, CDHB, CDNB, CDNC, CDND, CESA, CETA, CFKA, CGYA, CJEB, CJBA, CJSB.

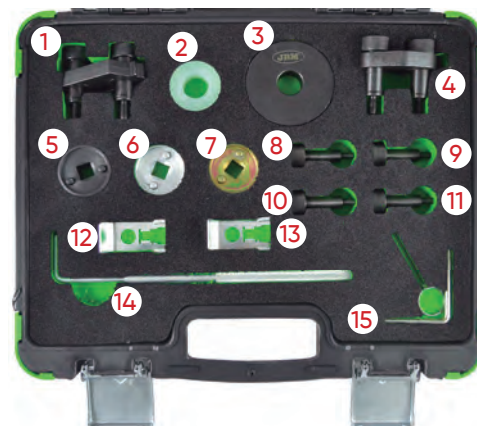

53287

245,00€



KIT DE BLOQUEIO VW/AUDI 1.8, 2.0L TURBO

MARCAS	VOLKSWAGEN AUDI	1.8 / 2.0 TURBO
FERRAMENTAS OEM	T10355 (1), T40196 (2), T40271 (3) (4), T10352 (5), T10352/1 (6), T10352/2 (7), T10368 (7), T40267 (8), T10354 (9), T40265 (10), T40011 (11) (14), T40098 (12), T10060A (13)	
CÓDIGOS DE MOTOR	BYT, BZB, CABB, CABD, CADA, CAEA, CAEB, CAWA, CAWB, CBFA, CCTA, CCZA, CCZB, CCZC, CDA, CDAB, CDHB, CDNB, CDNC, CDND, CESA, CETA, CFKA, CGYA, CJEB, CJS, CJSB.	

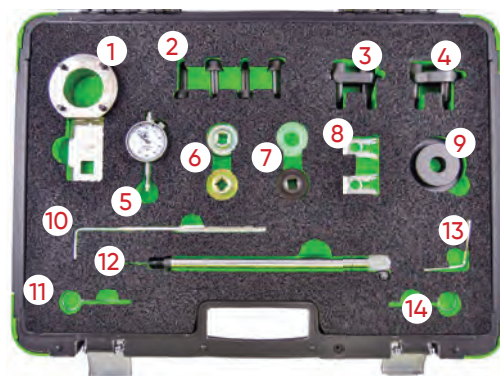

53288

72,00€

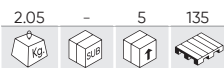

KIT DE BLOQUEIO VAG 1.6, 2.0 TDI COMMON RAIL

MARCAS	SEAT: EXEO, LEON, ALTEA, TOLEDO, IBIZA. VOLKSWAGEN: JETTA, TOURAN, GOLF, GOLF PLUS, POLO, PASSAT, TIGUAN, SCIROCCO. SKODA: ROOMSTER, FABIA, PRAKTIK, OCTAVIA, YETI, SUPERB. AUDI: A1, A3, A4, A5, Q5, A6, TT.
FERRAMENTAS OEM	T10264 (1), T10265 (2), T20102 (3), T10052 (4), T10051 (5), T10255 (6), T10050 (7), T10100 (8), T40098 (9)
CÓDIGOS DE MOTOR	1.2 TDI CR, 1.6 D TDI CR, 2.0 D TDI CR CAGA, CAGB, CAGC, CAHA, CAHB, CFHC, CBAA, CBAB, CFFB, CGLA, CGLB, CJCA, CJCB, CAAA, CBAA, CBAB, CBAC, CBBA, CBBB, CBDA, CBDB, CBDG, CCHA, CEGA, CJAA, CAAB, CAAC, CFJA, CFWA, CAYB, CAYC, CAYA.



53320

12,00€

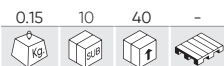

FERRAMENTA DE BLOQUEIO DE ÁRVORE DE CAMES GRUPO VAG

MARCAS	SEAT: ALHAMBRA, ALTEA, AROSA, CORDOBA, IBIZA, LEON, TOLEDO 1.4/1.9/2.0 TDI. VW: PASSAT 1.9. AUDI: A4/A6 1.9.
FERRAMENTAS OEM	T10008, T20102, T10100.



53321

10,50€



FERRAMENTA AJUSTE TENSÃO CORREIA VAG

MARCAS	AUDI: A4/1.8T, 2.0 1999-2004 A6/1.8T 2002-2004 A4/3.0 (2002 -), A6/3.0 (2002 -), A8/7.0 (2003 -). VW: GOLF PASSAT 2.0 TDI DIESEL, GOLF 88-97, PASSAT 92-97, VW T4/2.0 1992-2004.
FERRAMENTAS OEM	T10020



53325

7,50€

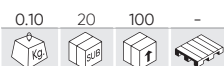

FERRAMENTA DE SINCRONIZAÇÃO DE POLIAS VW AUDI 35MM

MARCAS	AUDI: 100 ('91-), A6 (2.5 TDI) 2.3, 2.4, 2.5, 2.8, 2.9D TDI (1991-2003) VW: LT, TRANSPORTER
FERRAMENTAS OEM	3355
CÓDIGOS DE MOTOR	AAB, AAT, ACU, ACV, AEL, AET, AGX, AHG, AHY, AJA, AJT, ANJ, APA, APL, AUF, AVT, AXG, AXL, AYC.



53326

16,00€

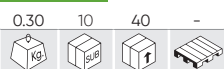

KIT DE BLOQUEIO VW/AUDI

MARCAS	VW: V6 2.5TDi. AUDI: V6 2.5TDi, V8 3.3TDi.
FERRAMENTAS OEM	3458 (1), 3242 (2)



53327

11,00€



KIT DE BLOQUEIO VAG 1.2

MARCAS	SEAT: IBIZA 1.2 6V/3CYL (2002-09), CORDOBA 1.2 12V/3CYL (2002-13). VW: POLO 1.2 6V-12V/3CYL (2002-14). SKODA: FABIA 1.2 6V-12V/3CYL (2002, 2003-), FABIA II 1.2 6V/3CYL (2007-13), ROOMSTER 1.2 12V/3CYL (2006-13), PRAKTIK 1.2 6V/3CYL (2007-13).
FERRAMENTAS OEM	T10123
CÓDIGOS DE MOTOR	1.2 6V: AWY, BMD, BBM, CHFA, CHFB 1.2 12V: AZQ, BME, BVX, BZG, CEVA, CGPA, CGPB, CGPC.



53648

107,00€



KIT DE BLOQUEIO DE DISTRIBUIÇÃO PARA VAG 1.0, 1.2, 1.4 TSI

MARCAS	AUDI: A1 (12-15), A1 SPORTBACK (12-15), A3 (13-15), A3 SPORTBACK (12-15). SEAT: IBIZA (12-15), LEON (12-15), TOLEDO (12-15). SKODA: FABIA (10-13), OCTAVIA II (10-13), OCTAVIA III (10-15).
FERRAMENTAS OEM	T10060A (1), T10340 (2), T10476 (3), T10494 (4), T10499 (5), T10504/1 (6), T10504 (7), T10504/2 (8).
CÓDIGOS DE MOTOR	1.2 TSI: CJZA, CJZB. 1.4 TSI: CGGA, CHPA, CMBA, CPVA, CRJA, CXSA. 1.4 TSI ACT: CPTA.

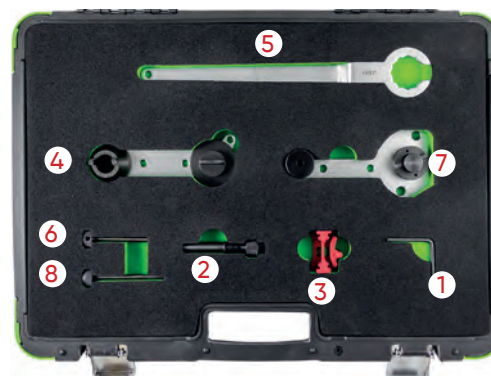

53649

89,00€

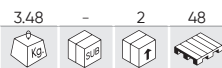

KIT DE BLOQUEIO GRUPO VAG

MARCAS	AUDI SEAT	SKODA VW
FERRAMENTAS OEM	T10340 (1), T10476 (2), T10477 (3), T10487 (4), T10494 (5), T10499 (6)	
CÓDIGOS DE MOTOR	1.0 MPI: CHYA. 1.0 TSI: CHZE, CHZC, CHZA, CHZB, CHZC, CHZD, CHZJ. 1.2 TSI: CJZB, CJZC, CYVA, CJZA, CJZD, CYVB. 1.4 TSI: CZCC, CMBA, CZCA, CHPA, CPTA (ACT), CZDA, CVNA, CZEA (ACT).	

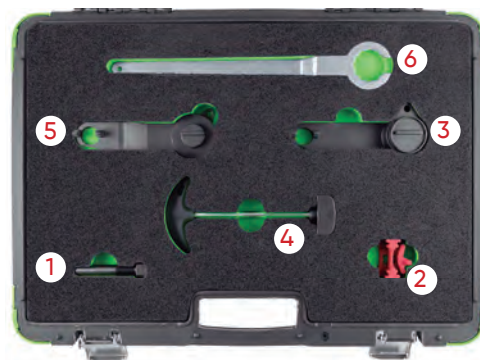

53706

98,00€

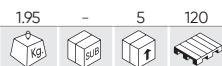

KIT DE ALINHAMENTO DA ÁRVORE DE CAMES VAG 1.4, 1.6, 2.0 TDI COMMON RAIL

MARCAS	VOLKSWAGEN: GOLF ALLTRACK, GOLF SPORTSVAN, GOLF VII, GOLF VII KOMBI, PASSAT, POLO. AUDI: A1, A1 SPORTBACK, A3, A3 CABRIOLET, A3 LIMOUSINE, A3 SPORTBACK, TT, TT ROADSTER. SEAT: IBIZA, IBIZA V SPORTCOUPE, IBIZA V ST, LEON, LEON SC, LEON ST, TOLEDO IV. SKODA: FABIA, FABIA KOMBI, OCTAVIA, OCTAVIA COMBI, RAPID, RAPID SPACEBACK.
FERRAMENTAS OEM	OEM 3204 (1), OEM 3359 (2), OEM T10490 (3), OEM T10051 (4), OEM T10060A (5), OEM T10264 (6), OEM T10265 (7), OEM T10492 (8), OEM T40098 (9).
CÓDIGOS DE MOTOR	1.4, 1.6, 2.0 TDI CR CXXB, DBKA, DCXA, GGLE, CKFB, CKFC, CLHA, CLHB, CNHA, CNHC, CRBD, CRFA, CRFC, CRKA, CRKB, CRLB, CRLC, CRMB, CRUA, CRVA, CRVC, CSUA, CSUB, CUNA, CUPA, CUSA, CUSB, CUTA, CUUD, CXEB, DBKA, DCXA, DCZA, DFSD.

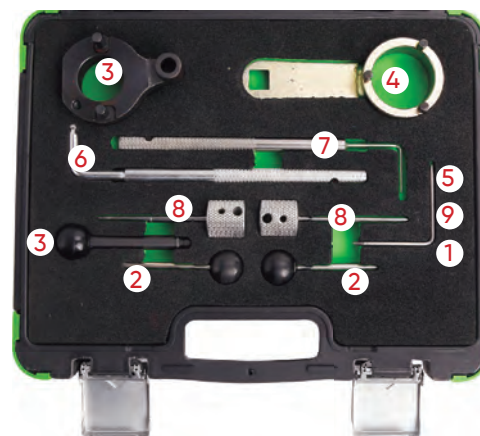

54092

24,00€



KIT DE CONTROLE E REGULAÇÃO DE FASE DE CRONOMETRAGEM PARA MOTOR 1.2 TFSI POR VAG (VW)

MARCAS	AUDI: A1, A3, A3 SPORTBACK, A3 CABRIO SEAT: ALTEA, ALTEA XL, IBIZA, LEON, TOLEDO SKODA: FABIA II, OKTAVIA II, PRAKTIK, RAPID, RAPID SPACEBACK, ROMMSTER, YETI VW: BEETLE, CADDY, CADDY MAXI, GOLF PLUS, GOLF VI, GOLF VI CABRIO, GOLF VI ESTATA, JETTA, POLO, TOURAN
FERRAMENTAS OEM	T10340(1), T10414(2), T10341(3)
CÓDIGOS DE MOTOR	CBZA, CBZB, CBZC

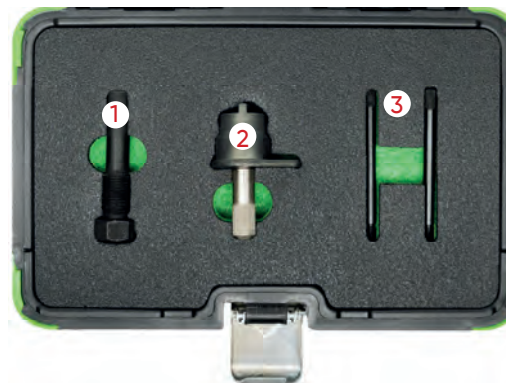

54199

94,00€

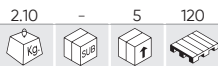

KIT DE BLOQUEIO DE DISTRIBUIÇÃO PARA VAG TFSI, FSI

MARCAS	AUDI: A1 (10-15), A1 SPORTBACK (10-15), A3 CABRIOLET (10-13), A3 (10-15), A3 SPORTBACK (03-13) SEAT: ALTEA/ALTEA XL (10-15), IBIZA (10-15), LEON (10-13), TOLEDO (12-15) SKODA: FABIA II (10-15), PRAKTIK (10-15), RAPID (12-15), RAPID SPORTBACK (12-15), OCTAVIA II (04-13), YETI (09-15), YETI OUT-DOOR (13-15) VW: BEETLE (11-15), CADDY/CADDY MAXI (10-15), EOS (07-15), GOLF V (03-13), GOLF V ESTATE (07-09), GOLF VI (10-13), GOLF VI ESTATE (10-13), GOLF VI CABRIOLET (11-15), GOLF PLUS (05-14), JETTA (05-14), PASSAT (05-15), POLO (09-14), SCIROCCO (08-14), TIGUAN (07-15), TOURAN (03-15)
FERRAMENTAS OEM	T10414 (1), VAS 6079 (2), T10170 (3), T10171/ T10171A (4), T40011 (5), T10340 (6), T10341 (7)
CÓDIGOS DE MOTOR	1.2 TFSI: CBZA, CBZB, CBZC 1.4 FSI/TFSI: BLG, BMY, BWK, CAVA, CAVB, CAVC, CAVD, CAVE, CAVF, CAXA, CAXC, CDGA, CSMA 1.6 FSI: BAG, BLF, BLP



54218

142,00€



FERRAMENTA DE MONTAGEM DE AMORTECEDOR DE VIBRAÇÃO VAG

MARCAS	AUDI, SEAT, SKODA, VOLKSWAGEN
FERRAMENTAS OEM	T10531/1 (1), T10531/2 (2), T10531/3 (3), T10531/4 (4)
CÓDIGOS DE MOTOR	1.8L TFSI: BZB, CDAA, BPU, BYT, CABA, CABB, CDHA, CDHB, CABD, DAJB, CJSA, CJSB, CJEB, CJEE, CJED, CYGA, CDAC, CJSC, CGYA, DAJA 2.0L TFSI: CAWB, CCZA, CBFA, CCTA, CDNB, CDNC, CDND, CJXA, CJXE, CJXH, CHHB, CHHA, CULA, CFKA, DEDA, CHJA, CAWA, CCZC, CCZD, CPSA, CJKA, CJKB, CESA, CETA, CFPA, CNCD, CPLA, CYRB, CYRC; CNCE, CYNB, CYPB, CULB, CULC, CNCB, CWZA, CJXF, CJXC, CJXB, CJXG, CHHC, CCZB



54407

397,00€



KIT DE FERRAMENTAS PARA O CONJUNTO DO EIXO-COMANDO DE VÁLVULAS VAG/PORSCHE

MARCAS	AUDI, PORSCHE, SEAT, SKODA, VOLKSWAGEN 1.2 - 1.6 - 2.0 - 2.7 - 3.0 - 4.0 - 4.2 COMMON RAIL
FERRAMENTAS OEM	T40094, T40094/1 (1), T40094/2 (2), T40094/3 (3), T40094/4 (4), T40094/5 (5), T40094/6 (6), T40094/7 (7), T40094/8 (8), T40094/9 (9), T40094/10 (10), T40094/11 (11), T40094/12 (12), T40095 (13), T40096 (14), T40096/1 (15)
CÓDIGOS DE MOTOR	ASB, ASE, BKN, BKS, BMK, BNG, BPP, BSG, BTR, BUG, BUN, BVN, CAAA, CAAB, CAAC, CAAD, CAAE, CAGA, CAGB, CAGC, CAHA, CAHB, CAMA, CAMB, CANA, CANB, CANC, CAND, CAPA, CARA, CASA, CASB,CASC, CASD, CATA, CAYA, CAYB, CAYC, CAYD, CAYE, CBAA, CBAB, CBAC, CBBA, CBBB, CBDA, CBDB, CBDC, CCFA, CCFC, CCHA, CCHB, CCLA, CCMA, CCWA, CCWB, CDBA, CDCA, CDSB, CDTA, CDTB, CDUC, CDUD, CDYA, CDYB, CDYC, CEGA, CEXA, CFCA, CFFA, CFFB, CFFD, CFFE, CFGB, CFGC, CFGD, CFHA, CFHB, CFHC, CFHD, CFHE, CFHF, CFJA, CFWA, CGKA, CGKB, CGLA, CGLB, CGLC, CGLD, CGLE, CGQB, CJAA, CJCA, CJCB, CJCC, CJCD, CJGA, CJGC, CJGD, CJMA, CKDA, CKTB, CKTC, CKUB, CKUC, CKVB, CKVC, CLAA, CLAB, CLCA, CLCB, CLJA, CLLA, CLNA, CLZB, CMEA, CMFA, CMFB, CMGB, CMHA, CNEA, CNFA, CNRB, CRCA,CSHA, M05/9D(CAS), M05/9E, M05/9E(CRCA), M05/9E(CRCB)

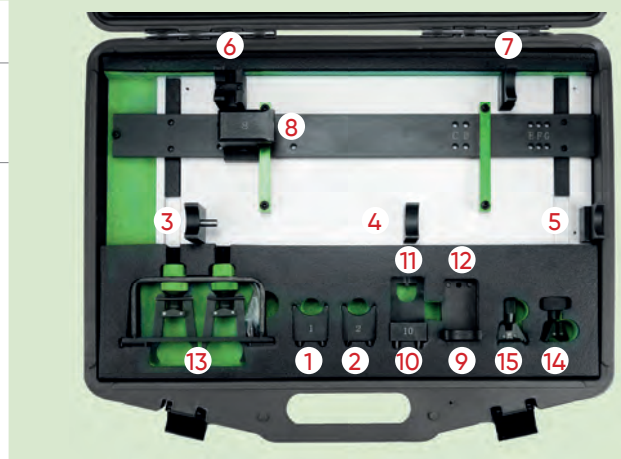

54408

46,00€



N

CONJUNTO DE FERRAMENTAS DE BLOQUEIO DO MOTOR VAG DIESEL 1.7, 1.9, SDI, TDI

MARCAS	AUDI: A3, A4, A6, CABRIOLET, SEAT: ALHAMBRA, AROSA, CORDOBA, IBIZA, INCA, LEON, TOLEDO, SKODA: FELICIA, OCTAVIA VW: BORA, CADDY, FOX, GOLF, LT, LUPO, PASSAT, POLO, SHARAN, TRANSPORTER, VENTO
FERRAMENTAS OEM	T1020 (1), 2587 (2), 2065A (3), T20044 (4), T10098 (5), T40011 (6), 2064 (7), T3359 (8), T10092 (9), M5x60M (10)
CÓDIGOS DE MOTOR	1.7TDi/SDi: AHB, AHG, AKU, AKW 1.9TDi/SDi: 1X, 1Y, 1Z, ABL, AAZ, AEF, AEY, AFF, AFN, AGD, AHF, AHH, AHU, AGP, AGR, ALE, ALH, AQM, ASV, ASY, ASX, AVG, AYQ 2.4D: 1G, 1S, DW, DV, ACL, ACT

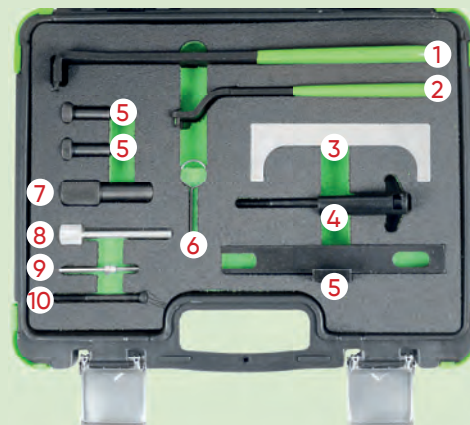

54409

32,00€



N

KIT DE BLOQUEIO VAG 1.4 TSI

MARCAS	ATECA (2016-) A3 (2012-) SUPERB (2015-) A1 SPORTBACK (2012-2018) LEON/LEON ST (2012-2020) MK5 (2012-2018) Q2 (2016-) Q3 (2015-2018)
FERRAMENTAS OEM	T10340 (1) T10504 (2) T10504/1 (3) T10504/2 (4)
CÓDIGOS DE MOTOR	1.4 TFSI (CoD)-CPTA, CZEA 1.4 TSI (ACT)-CPTA, CZEA

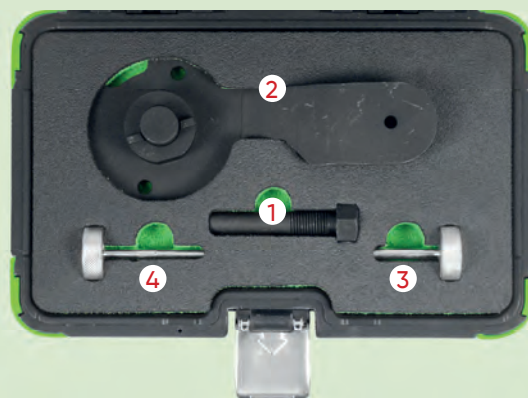

54410

33,50€



N

KIT DE BLOQUEIO VAG 2, 3.2 FSI

MARCAS	AUDI: A4, A5, A6, A7, A8, Q5, Q7, R8, RS4, RS5, RS6, S4, S5, S6, S8 VW: TOUAREG
FERRAMENTAS OEM	T40058 (1) T40069 (2) T40071 (3) T40133 (3) T40133/1 (3) T40133/1/2 (3) T40133/2 (3) 40071 (4)
CÓDIGOS DE MOTOR	2.4: BDW 3.2: AUK, BKH, BPK 4.2: BAR, BNS, BVJ, CAUA, CDRA, CFSA, BYH, CNDA 5.0: BUH 5.2: BSM, BUJ, BXA, CMPA, CTPA, CTYA

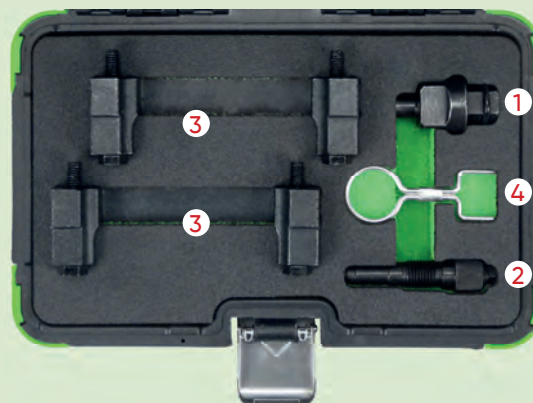

54411

36,00€



N

KIT DE BLOQUEIO VAG/PORSCHE 2.4, 2.8, 3.0 TFSI

MARCAS	AUDI: A4 (2011-2015) A5 (2007-2017) A6 (2007-2018) A7 (2010-2018) A8 (2010-2018) A8 (2010-2018) Q7 (2010-2018) S4 (2009-2017) S5 (2010-2017) S5 (2010-2017) Q5 (2008-2017) SQ5 (2013-2018) PORSCHE: CAYENNE (2010-2014) PANAMERA 2011-2013 VAG: TOUAREG (2010-2014)
FERRAMENTAS OEM	T40133/1 (1) T40133/2 (2) T40058 (3) T40069 (4) T40071 (5)
CÓDIGOS DE MOTOR	AUDI: 2,5 CLXB, CPAA 2,8 BDX, CCDA, CCEA, CHVA, CJBA, CNYA 3,0 CAJA, CAKA, CCAA, CGEA, CGWA, CGWB, CGWC, CGWD, CGXB, CGXC, CHMA, CHMB, CJTB, CJTC, CJWC, CMDA, CMUA, CNA, CREA, CREC, CRED, CTTA, CTUA, CTUD, CTVA, CTWA, CTXA 3,2 CALA, CALB PORSCHE: 3,0 M06/EC VAG: 3,0 CJTA, CGFA

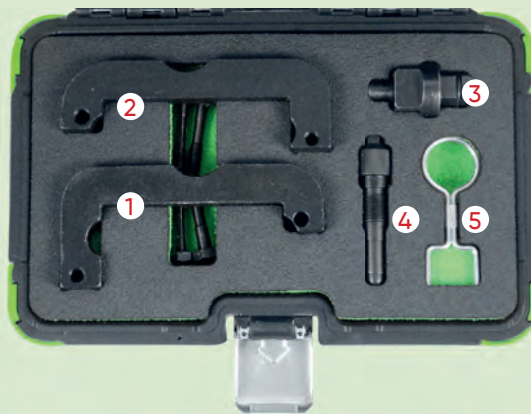

54412

57,00€



N

KIT DE BLOQUEIO AUDI 2.5 TFSI

MARCAS	AUDI: RSQ3 (2013-2015), RSQ3 (2015-2018), RS3 (2010-2013), RS3 (2015-2017), TT (2009,2014)
FERRAMENTAS OEM	T03003 (1) T40264/1/2 (2), T40264/2A (2) T40069 (3) T40011 (4) T40297 (5)
CÓDIGOS DE MOTOR	2,5 TFSI/RS CEPA, CEPB, CTSA, CZGA, CZGB

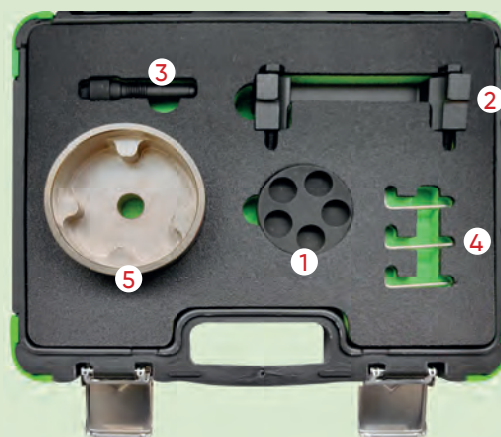

54413

115,00€



N

KIT DE BLOQUEIO AUDI 4.0 FSI, TFSI

MARCAS	AUDI: A8, RS6, RS7, S6, S7, S8 (2012-2018)
FERRAMENTAS OEM	T40071 (1) T40257 (2) T40264/1 (3) T40264/2 (4) T40264/3 (5) T40269 (6) T40272 (7)
CÓDIGOS DE MOTOR	CEUA CEUC CGTA CRDB CTFA CTGA CTGE CWUB CWUC DDTA

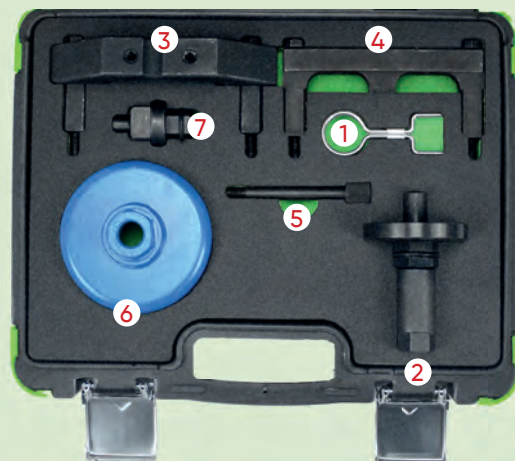

54431

184,00€

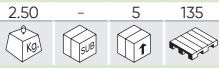

N

KIT DE BLOQUEIO ALFA ROMEO/MASERATI 2.9

MARCAS	ALFA ROMEO: GIULIA, STELVIO MASERATI: 3,8T
FERRAMENTAS OEM	1860815000 (1) 2024000090 (2) 2024100000 (3)
CÓDIGOS DE MOTOR	2.9: 670050436,670051007 ,670052721 ,670052722

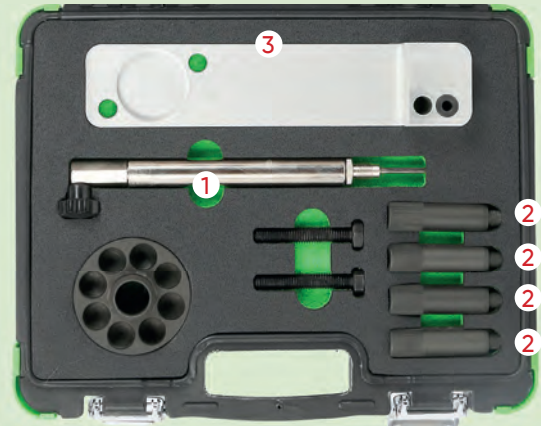

53315

285,00€

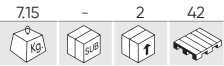

SET DE BLOQUEIO VOLVO 3.0, 3.2T6 / LAND ROVER 3.2

MARCAS	VOLVO: S60 (10-16), S80 (07-15), XC60 (08-15), XC70 (06-15), XC90 (10-14), V60 (10-15), V70 (10-15). LAND ROVER: FREELANDER II (11-14).
FERRAMENTAS OEM	VOLVO: 999-7263 (3), 999-7264 (1), 999-7272 (5), 999-7257 (2), 999-7261 (4). LAND ROVER: 303-1225 (3), 303-1226 (1), 303-1219 (2), 303-1223 (4).
CÓDIGOS DE MOTOR	3.0 TURBO: B6304T2, B6304T4. 3.2: B6324S, B6324S5. 3.2i6: B6324S.

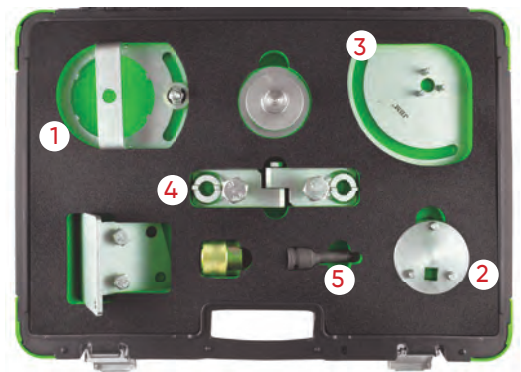

54226

71,00€

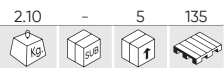

CONJUNTO DE EXTRACTOR PARA POLIA DE BOMBA DE ALTA PRESSÃO PARA HYUNDAI/KIA

MARCAS	HYUNDAI: ACCENT (11-15), ELANTRA (07-10), I20 (09-18), I20 (10-18), I20 COUPE (15-17), I30 (07-19), IX35 (10-16), I40 (11-18) KIA: CARENS (13-18), CEED (07-18), OPTIMA (11-15), PRO-CEED (08-19), RIO (09-17), CERATO (05-07), SOUL (09-14), SPORTAGE (10-18), VENGA (09-18)
FERRAMENTAS OEM	09331-2A000/2A010 (1), 09331-2A010 (1)
CÓDIGOS DE MOTOR	1.1D CRDI: D3FF 1.4D CRDI: D4FC(U1), D4FC(U2) 1.6D CRDI: D4FB(U1), D4FB(U2), D4FB-H(U1), D4FB-H(U2), D4FB-L(U1) 1.7D CRDI: D4FD(U2), D4FD-H(U2), D4FD-L, D4FD-L(U2)



54200

56,00€

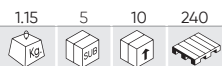

KIT DE BLOQUEIO DE DISTRIBUIÇÃO PARA PORSCHE

MARCAS	911 (2001 - 2008), BOXSTER (2002 - 2011), CAYMAN (2006 - 2009)
FERRAMENTAS OEM	9685 (1), 9686 (2), 9595 (3), 9595/1 (4)
CÓDIGOS DE MOTOR	M96/03, M96/05, M96/23, M96/25, M97/20, M96/24, M96/26, M97/01, M97/21, M97/22.

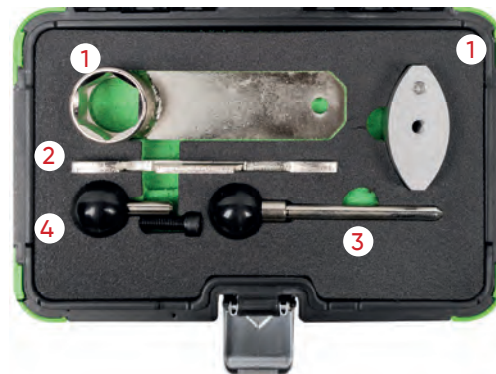

51927

25,00€



DESMONTADOR E TENSOR DE CORREIAS EN POLI-V



51340

39,30€



CHAVE UNIVERSAL PARA ÁRVORE DE CAMAS + ADAPTADORES



52616

44,00€

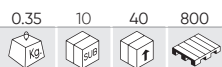

TENSIÔMETRO PARA CORREIA DE TRANSMISSÃO

- Dois escalas ajustáveis (daN) com leitura dianteira e traseira.

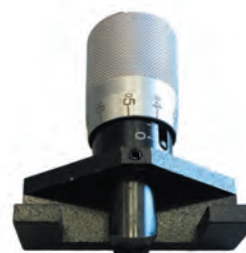

53769

178,00€

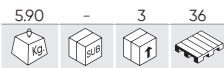

MÓDULO DE BLOQUEIO RENAULT/NISSAN/OPEL/VOLVO

MARCAS	<p>RENAULT: AVANTIME, CLIO, ESPACE, KANGOO, LAGUNA, MASTER, MEGANE, MODUS, SCENIC, TWINGO, TRAFFIC. OPEL/VAUXHALL: MOVANO, VIVARO. DACIA: DOKKER, DUSTER, LOGAN, SANDERO. NISSAN: ALMERA, INTERSTAR, KUBISTAR, MICRA, NOTE, PRIMERIA, QASHGAI. VOLVO: S40, V40</p>
FERRAMENTAS OEM	<p>MOT 1312 (1), MOT 1135-01 (2), MOT 1384 (3), MOT 1340 (4), MOT 1543 / KM-6234 / KV113 B0360 (5), MOT 1489 / KV113 B0130 (6), MOT 1536 / KM-6203 (7), MOT 1489 (8), MOT 1054 / KM-6031 / KV113 / B0280 (10), MOT 1318 (11), MOT 910 (12), MOT 910 (14), MOT 1386 (15), MOT 1534 / KM-6205 (16), MOT 1543 / KM-6234 / KV113 B0360 (17), MOT 1543 / KM-6234 / KV113 B0360 (18), MOT 1543 / KM-6234 / KV113 B0360 (19), MOT 1543 / KM-6234 / KV113 B0360 (20), MOT 1386 (22), MOT 1537 / KM-6204 (23), MOT 1348 (24), MOT 1538 (25), MOT 1337 (26), MOT 1496 / MOT 1750 (27), MOT 1490-01 (28), MOT 1200-01 (29)</p>
CÓDIGOS DE MOTOR	<p>PEROL: 2.0 16V, 2.5 20V, 1.4, 1.6 16V, 1.8, 2.0 16V, 1.2, 1.7, 1.8, 2.0 16V, 2.2 GASOIL: 1.9, 2.5, 2.8</p> <p>D4F702/706/708/712/714/716/722/728/730/740/764, D7F700/701/710/720/722/726/730/744/746/764/766, E7F700/704/706/750, E7J601/624/626/634/635/680/700/706/710/711/716/718/719/720/724/726/728/740/742/745/754/756/757/764/770/771/773/780, F3P670/682/700/704/706/708/710/712/714/720/724/755/758/760, F7P704/722, F3R611/722/723/728/729/750/751/752/791/796/797/798, F5R700/701/740, J7R732/733/734/735/768, F7R710/714, J7T600/760/761/762/766/772/780/782, N7Q704/710/711, N7U700/701, K4J700/710/711/712/713/714/715/730/732/740/750/770/780, K4M700/701/704/706/707/708/709/710/711/712/714/716/718/720/724/730/732/734/736/740/742/743/744/745/746/748/750/752/753/754/760/761/762/764/765/766/768/776/782/788/790/791/794/800/801/802/804/812/813/830, K9K700/702/704/706/710/712/714/716/718/722/724/728/729/732/734/740/750/752/760/762/764/766/768/802/804/806, F9Q610/650/664/670/674/71/716/717/718/720/722/730/731/732/733/734/736/738/740/744/748/750/752/754/758/759/760/768/762/770/772/774/780/782/784/786/788/790/796/800/803/804/808/812/816/818/820, G9T600/605/700/702/703/706/707/710/712/720/722/742/743/750, G9U720/724/726/730/750/754, F8M736/760, F8Q600/610/606/620/622/624/630/632/640/644/646/648/662/672/678/680/682/684/692/696/706/714/720/722/730/732/740/742/744/764/768/706/776/784/786/788, J8S620/621/622/758/760/776/778, G8T714/716/740/752/760/790/792/794, S8U720/722/730/731/742/748/750/752/770/772/780/782, S9U700/702/704/714/740, S9W700/702/206/208/212, E5F, E6J, K7M, F4P/F4R, FIN, F2N, F3N, F2R, F3P, F4P, F3R, J5T, J6R, J7R</p>

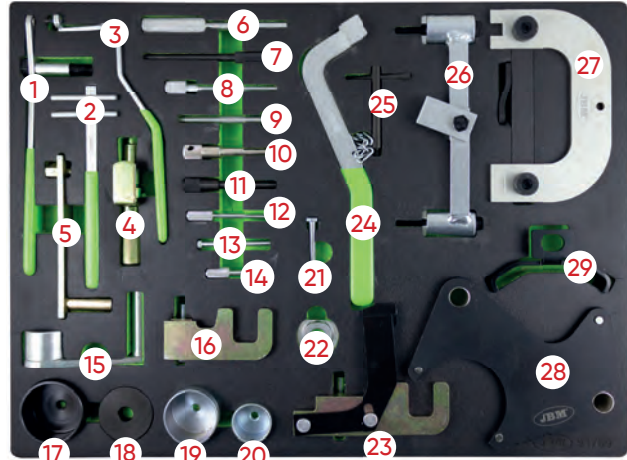

53773

298,00€



MODULO DE BLOQUEIO FIAT/ ALFA/LANCIA/OPEL/SUZUKI/FORD

MARCAS	<p>ALFA: ROMEO 145, 146, 147, 155, 156, 159, 166, SPIDER, GTV, TS, GT, CROSSWAGON Q4 FIAT: PUNTO, GRANDE PUNTO, BRAVA, BRAVO, MAREA, WEEKEND, STILO, DOBLO, CARGO, IDEA, PANDA, MULTIPLA, PALIO, STILO, 500 LANCIA: LYBRA, YPSILON, THESIS, MUSA OPEL: CORSA, AGILA, MERIVA, COMBO, VECTRA, ZARA, ASTRA, INSIGNA, SIGNUM 19 CDTI SUZUKI: IGNIS, SWIFT, WAGON R+ FORD: KA</p>
FERRAMENTAS OEM	<p>1860874000 (1), 1860874000 (2), 2000004400 / 2190754400 (3), 1860863000 (4), 1860898000 (5), 2190754500 (6), 2000004300 (7), 1870900400 (8), 1860703000 (9), 1860933000 (10), 1860845000 (11), 1870900300 (12), 1860905000 / EN-46788 (13), 1895443000 (14), 1860992000 (15), 1870896900 (16), 1860987000 (17), 1860905000 (18), 1860771000 (19), 1860161000 (20), 1860876000 (21), 1860876000 (22), 1871000900 (23), 1860985000 (24), 2000004200 / 2190754200 (25), 1860965000 (29)</p>
CÓDIGOS DE MOTOR	<p>176B9.000, 182B2.000, 188A5.000, 843A1.000, 323.02, 371.01, 182B4.000, 182B9.000, 186A6.000, 188A2.000, 188A7.000, 188B2.000, 192A1.000, 192A3.000, 937A2.000, 939A1.000, 192A5.000, 192B1.000, 198A5.000, 937A5.000, 939A2.000, 325.01, 342.02, 362.02, 185A6.000, 841C.000, 841G.000, 939A3.000, 940A3.000, 940A4.000, 940A5.000, Z19DT/DTH/DTR/DTL/DTL, 169A1.000, 955A4.000, 350A3.000, 192B4.000, 198A2.000, 350A2.000, 955A3.000, 192A8.000, 198A6.000, 198A3.000, 199B1.000, 199B2.000, 199A2.000, 199A3.000, 199A9.000, 188A3.000, 188A8.000, 188A9.000, 192A9.000, 186A8.000, 186A9.000, 199A5.000, 223A7.000, 223A9.000, 841H.000, 841P.000, 185A2.000, Z13DT, Z13DTJ, Z13DTH, 182A4.000, 182A6.000, 182B6.000, 178B3.000, 186A3.000, 186A4.000, 350A1.000, 169A4.000, 188A4.000, 199A4.000, 199A7.000</p>

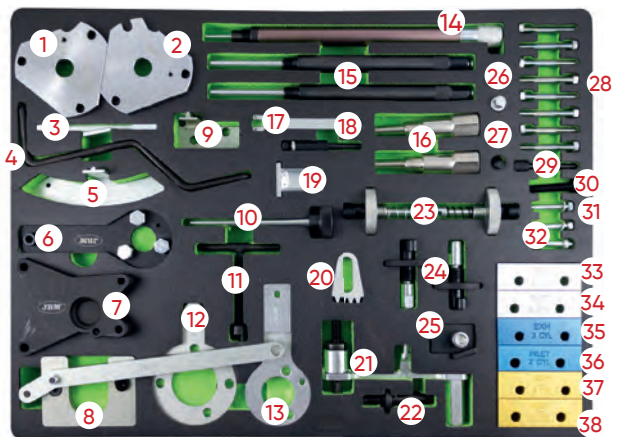

53770

198,00€

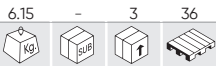

MÓDULO DE BLOQUEIO FORD/SEAT/VOLKSWAGEN/MAZDA/VOLVO

MARCAS	FORD: FIESTA, FUSION, COURIER, ESCORT, FOCUS, FOCUS C MAX, PUMA, MONDEO, SIERRA, COUGAR, GALAXY, C-MAX, ORION, TOURNEO CONNECT, TRANSIT, TRANSIT CONNECT. VW: SHARAN. SEAT: ALHAMBRA. MAZDA: 121. VOLVO: S40, V50.
FERRAMENTAS OEM	303-1061 (1), 303-1054 (2), 23-059 / 310-085 (3), 21-105 (4), 323-029 (6), 0194-B / 21-263 / 303-735 / 49 JE 02 021 (7), 0132-AB / 0178-D / 21-151 (9), 0194-C, 21-262, 303-734, 49 JE 02 020 (10), 21-238 / 303-679A / 303-1151 (11), 21-238 / 303-679A / 303-1151 (12), 303-1054 (13), 303-1151 (14), 21-238 / 303-679A (15), 303-393 / 303-393-02 (16), 303-1097 (17), 21-168 / 303-393 (18), 303-0985 (20), 2064 / 23-047 / 310-055 / U20003 (21), 303-652 (22), 21-229, 303-651 (23), 303-748 (24), 21-210 (25), 21-260, 303-732 (26), 21-163, 303-620 (27), 21-234 / 21-251 (28), 303-675 / 303-698 (29), 21-104 / 303-193 (30) / 21-162B / 303-367 / 303-376 (31), 21-162B / 303-376 / 303-376B (32), 23-019 (33), 23-058 / 310-084 (34), 0153-M / 0178-C / 0178-D (35), 0178-B / 5711-TB (36), 21-123 (37), 23-020 (38), 21-234 / 21-251 (39), 303-1059 (40), 23-019 (41), 303-1060 (42), 303-393 / 303-393-01 (43)
CÓDIGOS DE MOTOR	FUJA, FUJB, FXJA, FXJB, FYJA, FYJB, F8JA, F8JB, M7JA, M7JB, DHA, DHB, DHC, DHD, DHE, DHF, DHG, FHA, FHE, LIT, LIV, LIE, LIG, LIH, LIK, RDA, RDB, RKC, RQB, RQC, FXDA/C, FXDB/D, FYDA/C, FYDB/D, FYDH, HWDA1Z, AHU, AVG, AFN, D24, D24T, D24TIC, RFN, RTJ, RTK, RVA, RFK, RKD, B4164S3, DV4TD (8HW/8HX/8HZ), DV4TED4(8HV/8HY), DV6ATED4 (9HX/9HY/9HZ) F6JA, F6JB, F6JC, G8DA, G8DB, KKDA, SNJA, SNJB, STJA, STJB, ASDA, ASDB, FXJC, SPJA, SPJC, FYJC, HWDA, HWDB, SHDA, SHDB, SHDC, JQDA, LQDB, JTDA, JTDB, HXDA, HXJA, HXJB, IQDA/B, IQDB, PNBA, PNDA, RHBA, SIDA, F6JD, TZJA, TZJB, HHDA, HHDB, HHJA, HHJC, HHJD, HHJE, HHJF, RTA, RTB, RTC, RTD, RTE, RTF, RTH, RTJ, RTK, RFN, BHPA, HCPA, HCPB, KKDA, P7PA, P9PA, P9PB, R2PA, R3PA, RWPA, RWPC, F9DA/B, FFBA, FFWA, KHBA, QYBA, QYWA, KKDB, C9DC, RVA, 1Z, AFN, AHU, ANU, AUY, G6DA, G6DB, G6DC, G6DD, G6DE, G6DF, G6DG, UFDB, TXDB, TYDA, UKDB, QXBA, AZBA, KLBA, QXBB, LPBA, AZBC, TYBA, UKBA, UFBA, TXBA, IXDA, QXWA, QXWB, AZWA, KLWA, AZWC, TYWA, UKWA, TXWA, UFWA, UFDA, TXDA, UKDA, Q4BA, KNBA, 4BA, 4BB, 4BC, 4CC, 4FA, 4CA, 4CB, 4DA, 4EA, 4FA, 4FB, 4FC, 4FD, 4GA, 4HB, 4HC, 4EB, 4EC, 4ED, 4GA, 4GB, 4GC, 4GD, 4GE, 4GF, 4HA, 4HD, FMBA/B, D5BA, ABFA, D3FA, D6BA, HJBA/B, F3FA, D2FA, D4FA, F4FA, F1FA, DOFA, QJBA, QJBB, QJBC, QJBD, FXFA, H9FA, H9FB, N7BA, N7BB, MZ-CD 1.6, Y6

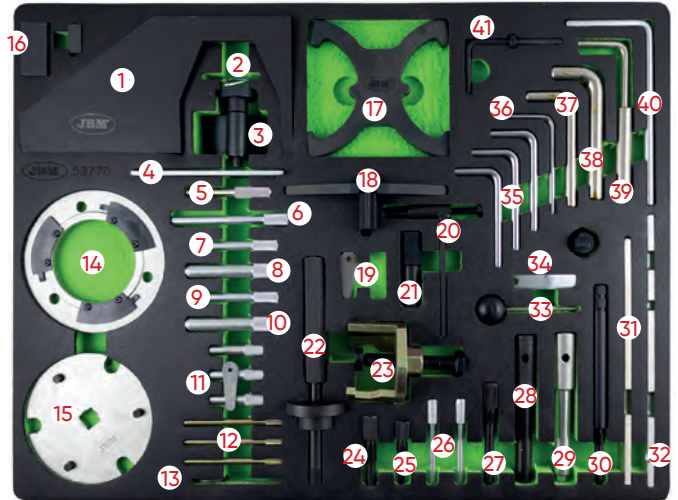

53774

190,00€

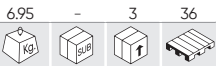

MÓDULO DE BLOQUEIO OPEL/CHEVROLET/SAAB/FIAT/LANCIA/SUZUKI/FORD

MARCAS	ALFA: 145, 146, 147, 156, 159, 166, GT, CROSSWAGON Q4 FIAT: PUNTO, GRANDE PUNTO, BRAVO, BRAVA, MAREA WEEKEND, STILO, DOBLÓ, CARGO, MULTIPLA IDEA, PANDA LANCIA: YPSILON, MUSA, LYBRA, THESIS OPEL: CORSA B/C, COMBO, TIGRA, AGILA, TIGRA B, MERIVA, ASTRA F/G/H, ASTRAVAN, SPEEDSTER VX220, ZAFIRA A/B, VECTRA B/C, SIGNUM, OMEGA B, SINTRA, FRONTERA A/B, ASTRAVAN, KADETT, ASCONA, OMEGA, MONTEREY, ANTARA, CROMA, SPEEDSTER VX220 SUZUKI: IGNIS, SWIFT, WAGON R+ FORD: KA CHEVROLET & DAEWOO: EPICA, CAPTIVA, NUBIRA, LACETTI, EVANDA SAAB: 9-3, 9-5 (98-04)
FERRAMENTAS OEM	1860905000 / 1860905010 / EN-46788 (1), KM-6148 (2), KM-6148 (3), 1870900400 / 1871000200 (4), KM-954 (5), KM-J-43651 (6), 1860905000 / 1860905010 / EN-46788 (7), KM-852 (8), KM-853 (9), 1870900300 / 303-1468 (10), EN-46785 / KM-951 (11), KM-932 (12), 1860703000 (13), KM-955 (14), KM-6130 / KM-6349 / KM-6349 (15), KM-927 (16), EN-48245 (17), KM-933 (18), EN-46785 (19), 1860985000 / 1871000900 / EN-46781 (20), 1860985000 / 1871000900 / EN-46781 (21), EN-48246 (22), KM-929 (23), 1870896900 / EN-46789 (24), KM-952 (25), 21-162B / 303-376 / 303-376B (26), KM-933 (27)
CÓDIGOS DE MOTOR	X14XE, Z14XE, X16SEJ, X16XE, X16XEL, Y16XE, Z16XE, Z16YNG, C18XEL, X18XE, X18XE1, Z18XE, Z18XEL, C20SEL, C20XE, X20XEV, Z20LEH, Z20LEL, Z20LER, Z20LET, X22SE, X22XE, Y22SE, Y22XE, Z22XE, D223L, X10XE, Z10XE, Z10XEP, X12XE, Z12XE, Z14XEP, X20DTL, X20DTH, X22DTH, Y20DTL, Y20DTH, Y22DTH, Y22DTR, 169A1.000, 955A4.000, 350A3.000, 192B4.000, 198A2.000, 350A2.000, 955A3.000, 192A8.000, 198A6.000, 198A3.000, 199B1.000, 199B2.000, 199A2.000, 199A3.000, 199A9.000, 940A3.000, 188A3.000, 939A2.000, 188B2.000, 188A8.000, 188A9.000, 323.02, 371.01, 937A2.000, 182B4.000, 182B9.000, 188A2.000, 188A7.000, 192A9.000, 186A6.000, 186A8.000, 192A1.000, 192A3.000, 192B1.000, 192A5.000, 186A9.000, 939A1.000, 199A5.000, 223A7.000, 223A9.000, 342.02, 362.02, 84TG.000, 84TH.000, 84IP.000, 939A3.000, 185A2.000, 185A6.000, Z13DT, Z13DTJ, Z13DTH, Z19DT, Z19DTH, Z19DTJ, Z19DTL, X10XE, Z10XE, Z10XEP, Z12XE, Z14XEP, X16S2R, Z16SE, 4EC1/T, 4EC1, 4EE1/T, 4EE1, X17DT, Y17DT, Y17DTI, Y17DTL, 16DA, 17D, 17DR/X, 7DTL, X17DTL, 4JX1/4, JG2T, 4FC1/T, 4FD1, X20DTL, Y20DTL, D223L Z20DMH, Z20DM, RA420, Z20S1, 194A1.000, Z22SE, Z22YH

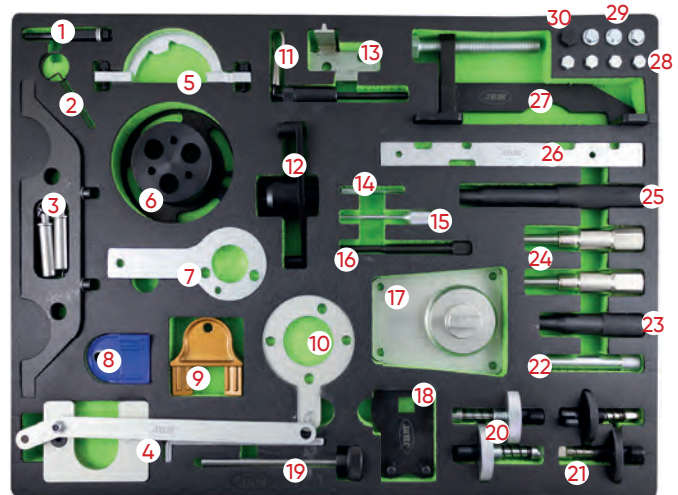

53771

158,00€



MÓDULO DE BLOQUEIO FIAT/FORD/CITROËN/PEUGEOT

MARCAS	<p>FIAT: ULYSSE, SCUDO, DUCATO LANCIA: ZETA, PHEDRA FORD: FIESTA, FUSION, FOCUS, FOCUS C-MAX CITROËN: C15, C1, C2, C3 PLURIEL, C4, C4 PICASSO, C5, C6, C8, DS3, DS4, DS5, XANTIA, XSARA, XSARA PICASSO, EVASION, BERLINGO, JUMPY, JUMPER, SAXO, ZX, XM, EVASION, AX PEUGEOT: 107, 1007, 206 CC, 207, 208, 306, 307 CC, 308, 406, 407, 508, 607, 806, 807, PARTNER, EXPERT, BOXER, 206, 106, 605, 205, 405</p>	
FERRAMENTAS OEM	<p>4200-TH (1), 0117-AR (2), 0188-X (3), 0606-A1.A2 (4), 0188-Q2 (5), 0189-S1 (6), 7017-TR (7), 0132-P / 4507-TL (8), 0189-C (9), 0188-J1 (10), 0188-J2 (11), 0178-E (12), 0189-R (13), 0132-AK / 0188-AK / 0189-K / 0153-AK / 4533-TAD / MOT 1436 (14), 0188-AH (15), 0189-S2 (16), 0153-AB / 9041-TZ (17), 0153-M / 0178-C / 0178-D / 7014-TM / 9767-94 (18), 0189-A (19), 4527-TS1 (20), 0153-AB / 9041-TZ (21), 0189-B / 21-163 (22), 0132-AJ1 / 0153-G / 0188-M / 0189-J / 4533-TAC1 / 5711-TA (24), 0189-L (25), 0188-D / 7017-TM (26), 0132-X / 0188-Q1 / 4507-TJ / 9767-89 (27), 0194-B (28), 0132-AB / 0194-A (29), 0194-C / 21-262 / 303-734 (30), 4527-TS2 (31), 0188-E (32), 0153-A / 6012-T / 9765-54 (33), 0134-AF / 0134-Q / 0188-F / 9004-T (34), 0188-P2 / 0188-P / 174 / 7015-T (35), 0153-U 7019-T (36), 0153-N / 0188-Y / 7014-TJ / 7099-TM / 9797-34 (37)</p>	
CÓDIGOS DE MOTOR	<p>F6JA, F6JB, F6JC, G8DA, G8DB, HHDA, HHDB, HHJA, HHJB CITROËN, PEUGEOT: 1.0 / 1.1 / 1.4 / 1.6 / 1.6 16V, 1.4 / 1.6HDI / 1.8 / 1.8 16V / 2.0 / 2.0 TURBO, 1.9D / 2.0HDI / 2.2HDI / 1.8 16V / 2.0 16V TU9 (CDY/CDZ), TU1 (HDY/HDZ/HFX/HFY/HFZ), TU3 (KDX/KDY/KDZ/KFX/KFZ), TU5JP4 (NFU/NFX), TU5 (BDY/BFZ/NFT/NFV/NFW/NFY/NFZ), XU7 (LFW/LFX/LFZ), EW7J4 (RLZ), XU7JP4 (LGY), XU10 (RFL/RFU/RFW/RFX/RGX/RGY), XU10JP4 (RGX/RGY), EW10A (RFJ), EW10J4S (RFK), EW10D (RLZ), EW12J4 (3FZ), ET3JE (KFU), TU3A/JP (KFV/KFW), DV4TD (8HW/8HX/8HZ), DV4TED4 (8HV/8HY), DV6ATED4 (9HX/9HY/9HZ), EW10-CVI (RLZ), EW12 (3FZ), DW8 (WJZ/WJY), DW10 (RHY/RHV/RHZ/RHS/RHM/RHW/RHT/RHR/RHX), DW12 (4HX/4HZ/4HW/4HY), EW7J4 (6FZ), EW10J4 (RFR), EW10J4D (RLZ), DW12TED4 (4HW), DW10ATED (RHT/RHV/RHW/RHX/RHZ) FORD 1.4 / 1.6 DURATORQ TDCI</p>	

53772

229,00€

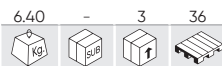

MÓDULO DE BLOQUEIO FORD/VAG/MAZDA/VOLVO

MARCAS	<p>AUDI: 80, A1, A2, A3, S3, A4, A5, A6, TT, Q5 SEAT: AROSA, IBIZA, CORDOBA, LEON, TOLEDO, ALHAMBRA, ALTEA, INCA (99-04) SKODA: FABIA, OCTAVIA, SUPERB VW: LUPO, POLO, FOX, GOLF, BORA, JETTA, GOLF PLUS, PASSAT, BEETLE, TOURAN, SHARAN, CADDY, CADDY MAXI, TRANSPORTER, GOLF VI CABRIO, TIGUAN FORD: GALAXY</p>	
FERRAMENTAS OEM	<p>T10252 (1), VAS6079 (2), T10121 (3), MP1-1312 / T10098 / T20038 / T20038 (4), T10123 (5), 23-058 / 310-084 / T10008 (6), 2065A / T10008 / U40021 (7), 3418 (8), T10171 (9), 23-059 / 23-059 / 310-085 / T10050 / T10050 (10), 3458 / T30094 (11), T10016 / T10074 / T10074 (12), T10100 (14), T10414 (15), 3366 / T20018 / T20044 (16), 3411 (17), 3369 / T30092 (18), T10341 (19), 3242 / T40069 / T30052 (20), T 40026 (21), 3359 / MP1-301 / T20102 (22), 2064 / U20003 (23), T10120 (24), MP1-1312 / T10098 / T20038 (25), T10170 (26), T00115 / T10264 / T40098 (27), T10092 (28), T00115 / T10264 / T40098 (29), 303-1054 / T10115 (30), T10060 / T10060A (31), 3359 / MP1-301 / T20102 (32), T10340 (33), 2587 (34), 3387 / U30009A (35), 3387 / T10020 (36)</p>	
CÓDIGOS DE MOTOR	<p>ARC, ATN, AUS, AVY, AZD, AFH, BCA, AJV, AKQ, AUA, AUB, AXP, AFH, AFN, AFK, AHW, AHU, APE, AQQ, AUS, AXP, AZD, BBY, BBZ, BCB, ANY, AYZ, AMF, ATL, BAY, BHC, BMS, BNM, BNV, BWB, AJM, AMG, ANU, ARL, ASZ, ATD, ATJ, AUJ, AVB, AVF, AVQ, AWX, AXB, AXC, AXR, BEW, BJB, BKC, BKE, BLS, BLT, BMT, BXP, BRB, BRM, BRR, BRU, BSU, BMT, BVK, BVK, BXE, BXF, AZV, BDJ, BDK, BGW, BHW, BKD, BKP, BLB, BMA, BMM, BMN, BMP, BMR, BNA, BPW, BRC, BRE, BRF, BRT, BUZ, BE, BVF, BVG, BVH, BWK, BTS, BMY, BLF, BWV, AZV, BKD, AWY, AZQ (55 - 64 PF), AXU, BAG, BKG, BLF, BLN, BLP, BVF, BKF, BNU, BVP, BVR, TZ, CBZA, CBZC, CBZB, CAXA, CAGA, CAGB, CAGC, CAHA, CAYA, CAYB, CAYC, CBAA, CBAB, CBAC, CBBA, CBBB, CBDA, CBDB, CBDC, CBEA, CEGA, CKUB, AZV, BDJ, BHP, BKD, BLB, BMA, BMN, BMN, BMP, BMR, BNA, BPW, BRC, BRE, BRF, BRT, BSS, BUJ, BUZ, BVA, BVE, BVF, BVG, BVH, BWV, ACV, AFB, AGX, AHD, AHY, AHY, AJT, AKE, ANJ, APA, AUF, AXG, AXG, AXL, AYC, AYM, AYY, BAU, BBE, BBF, BCZ, BDG, BDH, BFC, BJJ, BJK, BJL, BJM</p>	

FERRAMENTAS DE SINCRONISMO

CARRO COM 7 GAVETAS ESPECIAL KIT DE BLOQUEIO

53951 1.794,00€



COM FERRAMENTAS

53952 1.794,00€

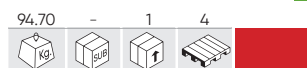

COM FERRAMENTAS

54501 1.794,00€



COM FERRAMENTAS

54502 1.794,00€

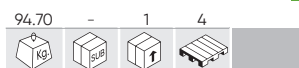

COM FERRAMENTAS

MEDIDAS INTERIOR

GAVETAS MENINHAS (X5)



GAVETAS GRANDES (X2)



CAPACIDADE DE CARGA POR GAVETA: 30KG.
CAPACIDADE TOTAL DE CARGA: 70KG.

DIMENSÕES GERAIS



COM MÓDULOS EVA:

MÓDULO DE 6 FERRAMENTAS DE SINCRONIZAÇÃO DE MOTOR

53775 1.109,00€



GASOLINA/PETROL

DIESEL/GASOIL

CONTÉM

REF.	KG	SUB	1	€
53769	5.90	-	3	178,00€
53770	6.15	-	3	198,00€
53771	4.05	-	3	158,00€
53772	6.40	-	3	229,00€
53773	6.60	-	3	298,00€
53774	6.95	-	3	190,00€

53769



RENAULT / NISSAN / OPEL / VOLVO

53770



FORD / SEAT / VOLKSWAGEN / MAZDA / VOLVO

53771



FIAT / FORD / CITROËN / PEUGEOT

53772



FORD / VAG / MAZDA / VOLVO

53773



FIAT / ALFA / LANCIA / OPEL / SUZUKI / FORD

53774



OPEL / CHEVROLET / SAAB / FIAT / LANCIA / SUZUKI / FORD

PARA MAIS INFORMAÇÕES

PÁGINA 297

ACESSÓRIOS E PEÇAS SOBRESSALENTES

PÁGINA 90

300 IVA não incluído



www.jbmcamp.com

ACESSÓRIOS DE LUBRIFICAÇÃO

- 302 BOMBAS DE ABASTECIMENTO DE COMBUSTÍVEL DIESEL
- 303 BOMBAS DE ABASTECIMENTO DE UREIA
- 304 BOMBAS DE ENCHIMENTO/EXTRAÇÃO
- 307 COLETORES DE ÓLEO
- 308 PISTOLAS DE SUCCÇÃO
- 309 BALDES DE COLEÇÃO DE ÓLEO
- 310 OUTROS



53697

398,00€

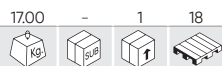

BOMBA DE COMBUSTÍVEL DIESEL COM DOSADOR E INDICADOR (200-240 V)



- Tensão nominal: 200-240V.
- Potência nominal: 550W.
- Máx. vazão: 60 l/min.
- Comprimento do cabo: 2m.
- Comprimento da mangueira de sucção: 2m.
- Comprimento da mangueira de pressão: 4m.

COM PARADA AUTOMÁTICA



REPOSIÇÕES DISPONÍVEIS

53610

294,00€



BOMBA DISPENSADORA DE DIESEL COM PISTOLA (230 V)



- Comprimento da mangueira de entrada: 2m.
- Comprimento da mangueira de saída: 4m.
- Elétrico.
- Fornecido com pistola e mangueiras.

COM PARADA AUTOMÁTICA



REPOSIÇÕES DISPONÍVEIS

53609

182,50€



BOMBA DISPENSADORA DE DIESEL COM PISTOLA (12 V)



- Comprimento da mangueira de entrada: 2m.
- Comprimento da mangueira de saída: 4m.

COM PARADA AUTOMÁTICA



REPOSIÇÕES DISPONÍVEIS

54100

265,00€



BOMBA DIESEL ELÉTRICA



- Comprimento do tubo de sucção: 850-1245mm
- Comprimento da mangueira: 2m
- Temperatura de trabalho: 5° - 40°C (41° a 104°F)
- Tensão CC: 12V
- Corrente alternada: 100-240V
- Comprimento do cabo: 4m



53645

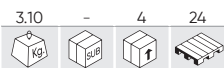

BOMBA ELÉTRICA PARA UREA AUS32



- Bomba de tambor elétrica projetada para meios à base de água, Urea AUS32 DEF e produtos químicos selecionados de tambores de metal de IBC de 205 L ou 1000-1250 L.
- Construção compacta e leve.
- Fusível incorporado para proteção contra sobrecarga e motor silencioso.
- Filtro de aço inoxidável embutido no tubo de sucção evitando que os contaminantes en-trem e causem danos.



268,00€



53644

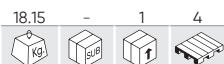

TANQUE DE UREA AUS32 (75 L)



- Uma construção autónoma e totalmente móvel de 75 L com uma bomba de 12V (permite atingir o desempenho no nível de 10 L/min com a pressão operacional de 40PSI), mangueira e válvula de fechamento automático.
- O tanque de polietileno que é resistente ao impacto, corrosão e UV.
- As rodas de grande diâmetro (200mm) permitem que sejam mano-bradas facilmente no terreno desigual.



1.238,00€



15631

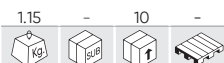

PISTOLA AUTOMÁTICA PARA UREA AUS 32 (POS. NO. 53645)

6 BAR



98,00€

52329



BOMBA MANUAL PLÁSTICA DE EXTRAÇÃO



- Para bidões de 25, 50, 200L.
- 350ml por caudal.
- Corpo e pistão de polipropileno.
- Cabo de plástico ABS.
- Aplicações: alcoóis, óleos, gasolina, diesel, queroseno, etc.
- Conducto de sucção:
 - Comp. mínimo: 320mm.
 - Comp. máximo: 900mm.



36,40€



13982

4,00€



ADAPTADOR DE ROSCA DE TAMBORES PLÁSTICOS

- Permite o ajuste e compensação de várias roscas de tanques, tambores e bombas.



ACESSÓRIOS DE LUBRIFICAÇÃO

52601

397,00€

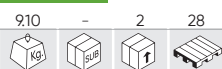

200L

BOMBA PARA TAMBOR DE ÓLEO + MANGUEIRA COM TORNEIRA

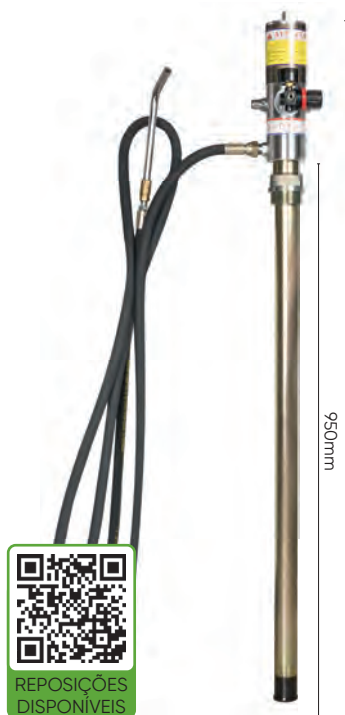

- Pressão bombagem: 5:1.
- Entrada Ar: 1/4".
- Saída Ar: 1/4".
- Pressão trabalho: 6-8 bar.
- Pressão Máx.: 8 bar.
- Consumo de Ar: 250 L/min.
- Capacidade relativa 6 bar: 18 L/min.
- Temperatura do óleo: -10~50°C.
- Viscosidade máxima: 240 SAE.
- Compr. do tubo: 950mm.

50918

341,00€



200L

BOMBA PARA TAMBOR DE ÓLEO



- Pressão Bombagem: 5: 1.
- Entrada Ar: 1/4".
- Saída Ar: 1/2".
- Pressão trabalho : 6 - 8 bar.
- Pressão Máx. : 8 bar.
- Consumo de Ar : 250 L/min.
- Capacidade relativa 6 bar: 18 L/min.
- Temperatura do óleo: -10~50°C.
- Viscosidade máxima: 240 SAE.
- Compr. do tubo: 950mm.

50935

595,00€



200L

KIT BOMBA ÓLEO PARA TAMBOR DE ÓLEO+MANGUEIRA+PISTOLA ÓLEO DIGITAL



- Viscosidade máxima: 240 SAE.
- Compr. da mangueira: 2 m.
- Compr. do Tubo: 950 mm.
- Capacidade relativa 6 bar: 18 L/min.
- Alcance de Temperatura do óleo: -10~50°C
- Consumo de ar: 250 L/min.
- Pressão Bombagem: 5: 1.
- Entrada de Ar: 1/4".
- Saída de Ar: 1/2".
- Pressão trabalho: 6-8 bar.
- Pressão Máx.: 8 bar.

53566

32,00€

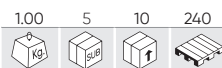

BOMBA DE ASPIRAÇÃO DE ÓLEO - 12V



- O extrator de óleo é um dispositivo ideal para trocas de óleo rápidas e limpas.
- Funciona ligando os grampos à bateria do carro de 12V.
- O óleo é simplesmente retirado do motor através do orifício do medidor de óleo.
- Use o extrator apenas para óleo de motor, óleo diesel ou óleo de aquecimento.



51253

41,00€

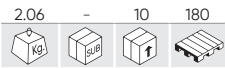

BOMBA DE ÓLEO MANUAL

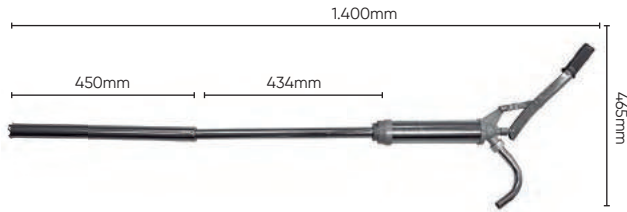

52428

40,00€

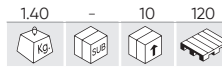

BOMBA MANUAL PARA EXTRAÇÃO

- Para bidões entre 50 e 200L.
- Caudal 400ml por impulso.
- Capacidade de caudal: 32 L x minut.
- Adaptador de boca de 2" incluído.
- Tubos de sucção de 101cm com entrada de 1 1/4" e saída de 1".
- Não permitido a: Ácidos fortes, lixívia, gasolina.
- Aplicações: óleos, lubrificantes, diesel, fluidos à base de óleo.
- Recomendado para: diluente de laca, líquido de travões, detergentes, glicerina, ácidos suaves fluidos à base de petróleo.



50917

271,00€

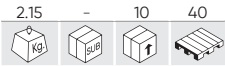

PISTOLA DE BOMBEAMENTO DE ÓLEO COM CAUDALÍMETRO DIGITAL

- Entrada de ar: 1/2" BSPF
- Taxa de fluxo: 1-35 L/min
- Pressão de trabalho: 6-8 bar
- Pressão máxima de trabalho: 100 Bar
- Alcance de Temperatura do óleo: -10-60 °C
- Viscosidade máxima: 240 SAE
- Bateria: 2x1.5V (bateria incluída)
- Precisão do caudalímetro: ±0,5%
- Repetibilidade do medidor de caudal: 0,2%
- Taxa de descarga por rotação: 25ml/R



53627

22,50€

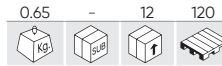

KIT DE EXTRAÇÃO DE ÓLEO E COMBUSTÍVEL

1,6L

O dispositivo é projetado e fabricado para a remoção rápida de óleo, combustível e óleo de transmissão/diferencial de tanques de geradores, lavadoras de alta pressão, compressores pneumáticos, tratores de jardim ou veículos todo-o-terreno.



REF. DESCRIÇÃO

REF.	DESCRIÇÃO	kg	L	mm	€
10000	RELÓGIO PISTOLA MEDIDORA DIGITAL P/50917	2.10	-	7,00€	

52797

198,00€

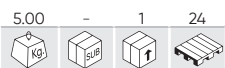

BOMBA MANUAL PARA SISTEMAS DE TRANSMISSÕES

- Capacidade: 7,5L.
- Descarga: 80cc ciclo.
- Alcance de viscosidade até SAE 140.
- Suporta enchimento e esvaziamento



REF. DESCRIÇÃO

REF.	DESCRIÇÃO	kg	L	mm	€
13234	BOMBA DE ENCHIMENTO SISTEMA TRANSMISSÃO SEM ACESSÓRIOS P/52797	3.75	24	224,50€	

12044

147,00€

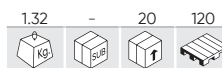

SET DE ADAPTADORES PARA O SISTEMA DE BOMBA DE TRANSMISSÃO (15 ACCESOIRES)

- ATF101: FORD 1/8 - 27 (NPT).
- ATF102: Universal BMW, Honda, Nissan, etc.
- ATF103: VW/Audi. Skoda.
- ATF104: VW/Audi. Porsche.
- ATF105: VW/Audi, Mini cooper M10x1.0
- ATF106: VW/Audi DSG M24 x 1.5
- ATF107: VW/Audi CVT M22x1.5
- ATF108: Mercedes M12 x 1.5
- ATF109: V/W. Skoda M18x1.5
- ATF110: Audi/VW, Skoda M30x1.5
- ATF111: Universal flexible 300mm. Honda. Hyundai. KIA...
- ATF112: Volvo 5/16 - 24 (UNF)
- ATF113: Toyota, Lexus M18 x 1.5
- ATF114: Nissan, Infinity M8 x 1.0
- ATF115: ATF-Adapter VW Passat



54290

4.307,00€

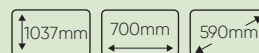

N

MÁQUINA DE TROCA DE ÓLEO DE TRANSMISSÃO AUTOMÁTICA

220V 50hz	150V	-10°C 50°C	40L	2 L/min	Error de intercambio equivalente Equivalent exchange error ±100ml
<90%	0-150 PSI	5µm	<70dB	70kg	

- Enchimento automático do fluido da transmissão
- Identificação automática da direção do líquido
- Limpeza automática
- Troca automática de líquido novo/usado
- Visualização dos níveis de pressão do líquido
- Exibição precisa da temperatura do fluido da transmissão
- Controle eletrônico inteligente
- Banco de dados atualizável
- Inclui adaptadores para diversas marcas
- Melhora o desempenho do sistema de transmissão automática



VÍDEO TUTORIAL



REPOSIÇÕES DISPONÍVEIS

54367

729,00€



N

KIT DE ADAPTADORES PARA REF. 54290 (105 PÇS)

CONTÉM



INFORMAÇÕES TÉCNICAS

54050

895,00€



MÁQUINA DE TROCA DE ÓLEO DE TRANSMISSÃO AUTOMÁTICA

- Fonte de alimentação: 12 V (bateria de carro)
- Potência da bomba: 70W
- Diâmetro do medidor de pressão de óleo: 70 mm (ambos os medidores de pressão de óleo)
- Faixa de medição do medidor de óleo: 0-10 bar (0-150 psi)
- Volume do tanque de óleo fresco: 30 l
- Capacidade do tanque de óleo residual: 30 l



VÍDEO TUTORIAL



REPOSIÇÕES DISPONÍVEIS

53874

398,00€

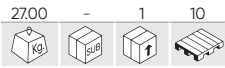

COLETOR DE ÓLEO COM SISTEMA DE ASPIRAÇÃO 90 LITROS TANQUE

90L 8-10 BAR



REPOSIÇÕES DISPONÍVEIS



PARA CAMIÕES/VEÍCULOS

- Pressão do ar de trabalho 8 ~ 10 bar
- Nível de vácuo: negativo 0 ~ 0,8 bar
- Volume do tanque: 70 l
- Volume do filtro de coleta 10 l
- Volume do copo de medição: 10 l
- Velocidade de sucção do óleo de acordo com o diâmetro da sonda: 0,8 l/min (Ø5x3,5 mm); 1 l/min (Ø6x4,5 mm); 1,6 l/min (Ø8x6,5 mm)
- Dimensões: 43x49x163 cm Meio: óleo do motor e óleo da transmissão
- Temperatura de óleo operacional recomendada: 40 ~ 60°C
- Com aspiração a vácuo.
- Sistema de medição pictórico.
- Grande tanque.
- Botão para controlar o uso.
- Rolos para fácil transporte.

53873

285,00€

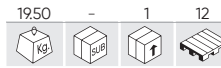

COLETOR DE ÓLEO COM 80 LITROS TANQUE

80L 1-3 BAR



REPOSIÇÕES DISPONÍVEIS



PARA CAMIÕES/VEÍCULOS

- Pressão do ar de trabalho 1-3 bar
- Volume do tanque: 70 l
- Volume do filtro de coleta 10 l
- Dimensões: 35x48x163 cm
- Meio: óleo do motor e óleo da transmissão
- Grande tanque.
- Botão para controlar o uso.
- Rolos para fácil transporte.
- Pode ser usado para óleos de alta temperatura (sem limitação).

15084

68,00€

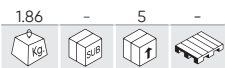

MÓDULO DE EXTRAÇÃO DE TAMPÕES DE CÁRTER

	x2 5/16", 3/8"		x7 8, 9, 10, 12, 13, 14, 17mm
	x7 7, 8, 10, 11, 12, 13, 14mm		x1 T45
	x1 10mm		x1 M16
	x1 10mm		x1 200mm
			x1 150mm



53215

19,00€

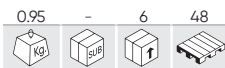

RECOLHEDOR DE ANTICONGELANTE. 18L

18L



53144

18,00€

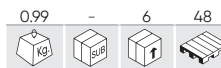

RECOLHEDOR DE ÓLEO 18L

18L



ACESSÓRIOS DE LUBRIFICAÇÃO

54051

39,00€

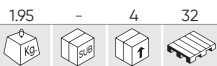

BANDEJA DE TROCA DE ÓLEO 8 L

8L

PE



51356

48,00€



BANDEJA DE AÇO PARA LÍQUIDOS

23L



52498

58,00€

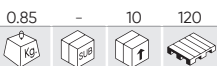

SERINGA TRANSPARENTE

1500 ml

PP

POM PVC

- Fabricada em polipropileno.
- Corpo transparente.
- Apta para usar em óleos de transmissão e diferenciais.
- Resistente a líquido de travões e anticongelantes.



TUBO FLEXÍVEL

52628

26,50€

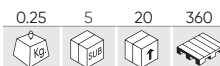

SERINGA TRANSPARENTE

200 ml

- Para fluido de freio.
- Conector rápido na ponta.



TUBO FLEXÍVEL

REF. DESCRIÇÃO

11867 DOS O-RINGS PARA REF. 52498

KG	SUB	€
0.02	100	9,00€

51928

14,00€

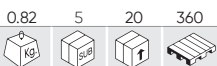

SERINGA DE SUCÇÃO DE ÓLEO

500 ml

Cr

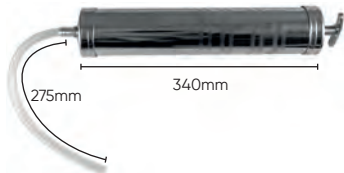

52789

15,20€



BOMBA MANUAL EXTRAÇÃO GASOIL



- Mangueira 90cm longo em cada extremidade.

50924

342,00€

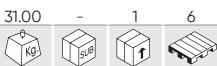

CARRO PORTA BIDÕES

200L



TANQUE DE ARMAZENAMENTO DE TAMBORES

52804
14.50 - 1 5
Kg SUP

343,00€
230L 400Kg

APROVADO DIBT
1 TAMBOR VERTICAL

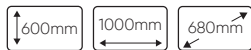

52805
13.35 - 1 6
Kg SUP

426,00€
250L 650Kg

APROVADO DIBT
2 TAMBORES VERTICAIS

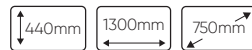

52806
17.50 - 1 5
Kg SUP

742,00€
250L 1250Kg

APROVADO DIBT
NÃO ADEQUADO PARA PORTA PALETES
4 TAMBORES VERTICAIS



53214
16.50 - 1 12
Kg SUP

285,00€



TANQUE DE ARMAZENAMENTO DE TAMBOR ESPECIAL EUROPALETE 2 BIDÕES

230L 650Kg

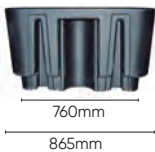

52807
30.00 - 1 7
Kg SUP

1.714,00€



TANQUE DE ARMAZENAMENTO - CONTAINER IBC 1000L

1000L 2500Kg



APROVADO DIBT



54498
221.00 - 1 -
Kg SUP

6.090,00€

CAPA DURA DO IBC

Permite o armazenamento de contentores IBC. Proporciona uma proteção máxima contra as intempéries para o contentor. Com tabuleiro de recolha de líquidos de 2 litros de capacidade, tabuleiro de retenção integrado e ranhuras de ventilação.

CAPACIDADE DO CONTENTOR DE 1000 LITROS: 1 UNIDADE

CAPACIDADE DO BIDÃO DE 200 LITROS: 4 UNIDADES

CAPACIDADE TOTAL DE CARGA: 2500KG.



CONTENTOR IBC NÃO INCLUIDO

2500Kg 2500mm 1775mm 1770mm

53612

96,00€

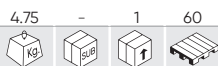

BRAÇADEIRA PARA TAMBORES (CAPACIDADE DE 500 KG.)



- Para lidar com bidão de óleo.
- Capacidade: 500kg
- Tipo de recolha vertical do bidão.
- Bidões de óleo especiais de 200L.



GALÃO DE METAL PARA COMBUSTÍVEL

REF.	L/mm				€
54181	5L - 550x260x350mm	1.45	4	72	25,10€
54182	10L - 570x350x425mm	2.55	4	48	34,70€
54184	20L - 760x370x500mm	4.10	4	24	44,00€



54183

38,20€



BIDÃO METÁLICO ANTI-TOMBOS 10L

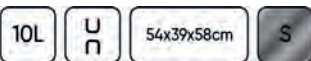

REF.	DESCRIÇÃO					€
15874	BOQUILHA FLEXÍVEL PARA BIDÃO METÁLICO (REF.54181, 54182, 54183, 54184)	0.30	-	50	800	6,50€

52452

8,00€

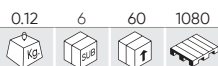

CHAVE PLÁSTICA PARA BIDÕES



- Material: Nylon.
- Anti-chispa.
- Pontas em acabamento de 3/4" e 2".
- Útil para bidões de 200L.

53078

18,00€

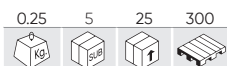

TORNEIRA PARA BIDÃO DE 200L



- Permite o esvaziamento rápido de tambores de 200 litros.
- Adequado para água, todos os tipos de óleos, álcool ou cetona, bem como ácidos fracamente concentrados e líquidos levemente alcalinos.
- Material: PE.
- Junta de EPDM.
- Mola em aço inoxidável.

53518

3,50€



TORNEIRA DE PLÁSTICO DE 3/4" PARA BIDÃO DE ÓLEO



- Adequado para todos os tipos de fluidos.
- 3/4" rosca externa.

52453

21,00€

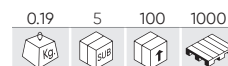

TORNEIRA DE 3/4" PARA BIDÃO DE ÓLEO DE 200L



- Torneira de segurança.
- Rosca de 3/4".
- Corpo de aleação.
- Junta de Nylon.
- Aplicações: Óleos, gasolina, diesel, queroseno.
- Válido para Urea AUS32.

52242

12,00€



GALHETAS DE ÓLEO 500ML

500ml



52243

8,50€



GALHETAS DE ÓLEO 0.25L

250ml



52991

10,50€



JARRO COM PESCOÇO FLEXÍVEL 2L

2L



52992

18,00€



JARRO COM PESCOÇO FLEXÍVEL 5L

5L



53187

39,00€

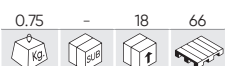

FUNIL PARA BIDÃO DE 200L COM TAMPA E FILTRO

4,5L



- Ø Interior: 245mm.
- Ø Exterior: 255mm.

53188

7,00€



JOGO DE 3 FUNILS

Ø 90,130,180mm



52391

5,00€

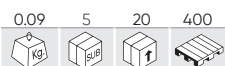

FUNIL COM FILTRO

950ml



140x15mm



53198

9,50€



FUNIL COM TUBO FLEXÍVEL

1,8L



Ø 180mm



53849



PISTOLA DE LUBRIFICAÇÃO COMPACTA



16,10€

50852

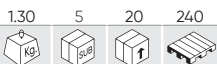

PISTOLA GRAXEIRA MANUAL COM TUBO FLEXÍVEL

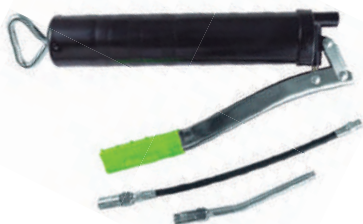

24,50€

50751

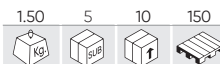

BOMBA DE MASSA PNEUMÁTICA

- Tubo rígido
- Tubo flexível
- Pressão: 30Mpa



43,00€

53592

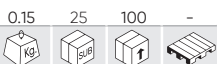

ACOPLADOR DE LUBRIFICAÇÃO DE LIBERAÇÃO RÁPIDA



25,00€

54255

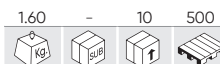

CONJUNTO COMPLETO DE ACESSÓRIOS PISTOLA DE LUBRIFICAÇÃO



68,00€

Recomenda-se usá-lo com as pistolas graxeiras JBM ref. 50751 e 50852, embora seja adequado para uso na maioria das pistolas.

60038

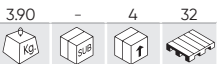

PISTOLA DE GRAXA PNEUMÁTICA ELLÉTRICA

BATERIA NÃO INCLUÍDA.

Esta ferramenta é uma pistola de graxa. Alimentada por bateria, a ferramenta é fácil de usar e transportar.

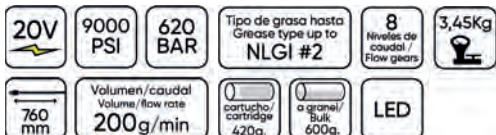

255,00€

FERRAMENTAS HIDRÁULICAS

- 314 MACACOS HIDRAULICOS DE RODAS
- 316 MACACOS TIPO GARRAFA
- 317 MACACOS DE MANIVELA
- 317 MACACO HIDRÁULICO TELESCÓPICO
- 318 CAVALETES
- 318 OUTROS
- 320 PORTA PALETES MANUAL
- 321 PRENSAS
- 322 GUINDASTES
- 323 MESAS DE ELEVAÇÃO
- 325 BASES SE ELEVAÇÃO



FERRAMENTAS HIDRÁULICAS

53725

248,00€

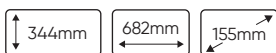
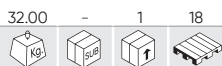

MACACO HIDRÁULICO DE RODAS 3T - SISTEMA RÁPIDO



MAX: 465mm
MIN: 133mm



REPOSIÇÕES DISPONÍVEIS

CUMPRE COM: EN 1494:2001

50818

198,00€

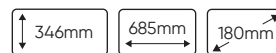

MACACO HIDRÁULICO COM RODAS 3,5T



MAX: 495mm
MIN: 133mm



REPOSIÇÕES DISPONÍVEIS

CUMPRE COM: EN 1494:2001

53422

368,00€



MACACO HIDRÁULICO 3TON COM ALAVANCA DE ELEVACÃO



MAX: 533mm
MIN: 100mm



REPOSIÇÕES DISPONÍVEIS

50815

88,00€



MACACO HIDRÁULICO DE RODAS 2T



MAX: 355mm
MIN: 130mm



REPOSIÇÕES DISPONÍVEIS

53112

298,00€

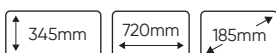

MACACO HIDRÁULICO COM PEDAL



MAX: 520mm
MIN: 140mm



REPOSIÇÕES DISPONÍVEIS

53968

49,00€



MACACO HIDRÁULICO COM RODAS 2T



MAX: 300mm
MIN: 130mm



REPOSIÇÕES DISPONÍVEIS

CUMPRE COM: EN 1494:2001

51895

99,00€

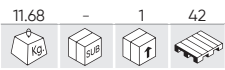

MACACO HIDRÁULICO COM RODAS 2T EM CAIXA PLÁSTICA



↑ MAX: 355mm
↓ MIN: 130mm



50816

88,00€

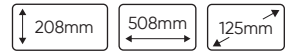
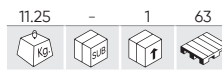

MACACO HIDRÁULICO DE RODAS 2T ESPECIAL CARROS BAIXOS



↑ MAX: 340mm
↓ MIN: 90mm



53421

298,00€

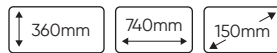
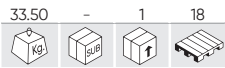

MACACO HIDRÁULICO DE RODAS 2T ESPECIAL CARROS BAIXOS



↑ MAX: 505mm
↓ MIN: 75mm



54137

288,00€

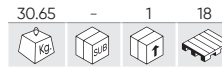

MACACO HIDRÁULICO DE RODAS 2,5T ESPECIAL CARROS BAIXOS



↑ MAX: 505mm
↓ MIN: 78mm

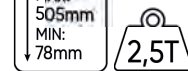

PISTÃO DUPLO

TUTORIAL DE MANUTENÇÃO



MACACOS HIDRÁULICOS PARA CARROS BAIXOS

SÃO UMA ADAPTAÇÃO IDEAL PARA VEÍCULOS DE PERFIL BAIXO, GRAÇAS À SUA ALTURA REDUZIDA E PROJETO EM CURVA.

FERRAMENTAS HIDRÁULICAS

MACACO TIPO GARRAFA

<p>50819 28,00€</p> <p>2.42 - 6 330</p> <p>↑ MAX: 345mm ↓ MIN: 181mm</p> <p>2T</p> 	<p>50820 34,50€</p> <p>3.20 - 6 300</p> <p>↑ MAX: 372mm ↓ MIN: 194mm</p> <p>3T</p> 	<p>50821 47,00€</p> <p>4.10 - 5 200</p> <p>↑ MAX: 413mm ↓ MIN: 216mm</p> <p>5T</p> 
<p>50822 59,00€</p> <p>5.60 - 4 200</p> <p>↑ MAX: 460mm ↓ MIN: 230mm</p> <p>10T</p> 	<p>52304 84,00€</p> <p>7.20 - 2 136</p> <p>↑ MAX: 365mm ↓ MIN: 225mm</p> <p>15T</p> 	<p>50823 94,00€</p> <p>10.18 - 2 96</p> <p>↑ MAX: 452mm ↓ MIN: 242mm</p> <p>20T</p> 
<p>50824 88,00€</p> <p>8.47 - 2 120</p> <p>↑ MAX: 355mm ↓ MIN: 190mm</p> <p>20T</p> <p>ESPECIAL CARROS BAIXOS</p> 	<p>50825 154,00€</p> <p>7.62 - 2 96</p> <p>↑ MAX: 465mm ↓ MIN: 285mm</p> <p>30T</p> 	

MACACO TIPO GARRAFA COM CAIXA PLÁSTICA

<p>51905 34,50€</p> <p>2.90 - 6 144</p> <p>↑ MAX: 340mm ↓ MIN: 185mm</p> <p>2T</p>  	<p>51906 39,00€</p> <p>3.53 - 4 144</p> <p>↑ MAX: 385mm ↓ MIN: 195mm</p> <p>3T</p>  	<p>51907 48,00€</p> <p>4.59 - 4 128</p> <p>↑ MAX: 450mm ↓ MIN: 215mm</p> <p>5T</p>  
---	---	---

JACK ELEVADOR 3T

REF.	Min.	Max.	mm				€
53895	130mm	330mm	510x265x140	9.15	1	42	107,00€
53896	130mm	645mm	840x265x140	11.60	1	28	127,00€
53897	130mm	1045mm	1220x265x140	13.85	1	21	140,00€
53898	130mm	1320mm	1520x265x140	15.65	1	21	148,00€



ACESSÓRIOS

REF.	DESCRIÇÃO				€
15093	SUPORTE DE MONTAGEM DE RODA	3.65	1	50	38,00€
15094	SUPORTE DO MACACO	1.35	5	140	39,50€
15095	RETENTOR DA ALÇA	0.10	50	-	13,00€
15096	DISPOSITIVO PARA ELEVAÇÃO POR RODA	2.00	10	560	40,00€



54001

285,00€

28.50	-	1	20

MACACO HIDRÁULICO DE FOSSA 0,5T

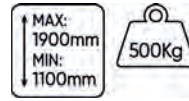

- Faixa de elevação de 116 a 197 cm.
- Apoio de posição dupla.
- Levantamento fácil e rápido com pedal.
- Válvula com mola para descida controlada.
- Permite levantar e mover caixas de velocidades, diferenciais, depósitos, etc. de forma segura e estável.



50830

560,00€

52.10	-	1	6

MACACO HIDRÁULICO DE TRANSMISSÃO 0,5 TON.



- Com empunhadura
- Rápido
- Pistão duplo



FERRAMENTAS HIDRÁULICAS

CONJUNTO DE 2 PREGUIÇAS

REF.	DESCRIÇÃO						€
53779	3T 290-430mm	5.05	-	1	72		36,00€
53845	6T 370-610mm	9.35	-	1	30		64,00€
54143	12T 500-770mm	35.50	-	1	12		249,00€



CONJUNTO DE 2 PREGUIÇAS 10 TON

REF.	DESCRIÇÃO						€
54145	10T 482-775mm	37.90	-	1	4		377,00€
54146	10T 736-1212mm	2.00	-	1	4		492,00€



54147

198,00€

18.00	-	1	40
-------	---	---	----

CAVALETE DE ELEVAÇÃO 1,8 TON (1220-2146MM)

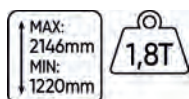

54144

298,00€

28.00	-	1	18
-------	---	---	----

CONJUNTO DE 2 SUPORTES DE MACACO 22 TON (338-500MM)

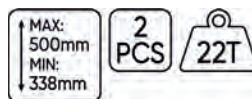

53200

69,00€

4.70	-	1	72
------	---	---	----

PREGUIÇA DE ALUMÍNIO 3T

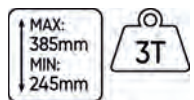

53218

26,00€

2.25	-	6	216
------	---	---	-----

MACACO DE TESOURA 1.5T

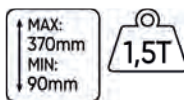

51901

999,00€

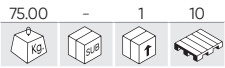

PORTA RODAS HIDRÁULICO CAP. 1T.



- Comprimento: 1040 mm
- Largura: 1090 mm
- Altura: 890 mm
- Faixa de elevação: 50-100 mm
- Máx. diâmetro da roda: 1320 mm

ESPECIAL CAMINHÕES



52241

1.690,00€



PORTA RODAS HIDRÁULICO 1.5TON



- Carga útil: 1.5 t
- Faixa de elevação: 0-770 mm
- Comprimento total: 1270 mm
- Largura total: 990 mm
- Altura total: 1340 mm
- Diâmetro máximo da roda: 2200 mm (86 ")
- Diâmetro mínimo da roda: 1000 mm (39 ")
- Largura máxima da roda: 800 mm



54257

318,00€

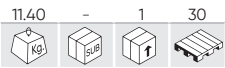

BOMBA HIDRÁULICA MANUAL

10000 PSI
3/8" NPT

PRESSÃO DE FUNCIONAMENTO:

- Etapa 1: 0-20 kg/cm³
- Etapa 2: 20-700 kg/cm³

1,8m

FLUXO:

- Etapa 1: 13cc
- Etapa 2: 2.3cc



50835

290,00€

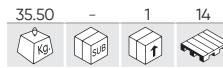

DOBRADORA DE TUBOS 12T



- Dobra tubos até 2" (50mm).
- Construção de aço.
- Barra de flexão ajustáveis.
- Pressão: 0,75 - 0,75mpa.
- Tamanho cunhas 1/2", 3/4", 1", 1-1/4", 1-1/2", 2".

FERRAMENTAS HIDRÁULICAS

53880

598,00€

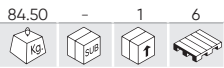

PORTA PALETES MANUAL ELEVÇÃO RÁPIDA

- Capacidade de levantamento: 2500kg
- Comprimento do empurrador: 1150mm
- Alça: Quadrado, emborrachado
- Volante (giratório): PU(200x50mm)
- Roda fixa: Duplo, PU (80x70 mm)
- Min. altura de forquilha: 85mm
- Máx. altura de foquilha: 200mm
- Número de cursos do pistão da bomba: 8

AÇÃO RÁPIDA
(AÇO FUNDIDO)



2,5T



REPOSIÇÕES
DISPONÍVEIS

54396

2.250,00€

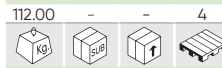

N

EMPILHADOR DE PALETES ELÉCTRICO



1,5T



REPOSIÇÕES
DISPONÍVEIS



INFORMAÇÕES
TÉCNICAS

50839

180,00€

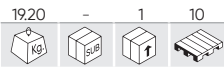

PORTA CARROS HIDRÁULICO 680KG

680Kg



REPOSIÇÕES
DISPONÍVEIS



50923

454,00€

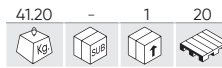

CARRO TRANSPORTADOR ESP. CHAPEIROS

340Kg



REPOSIÇÕES
DISPONÍVEIS



52514

84,00€

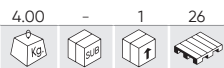

SUPORTE ELEVADOR DE MOTAS

200Kg



REPOSIÇÕES
DISPONÍVEIS



51751

99,00€

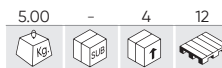

SUPORTE ELEVADOR DE MOTAS

200Kg



REPOSIÇÕES
DISPONÍVEIS



53684

1.880,00€

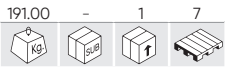

PRENSA HIDRÁULICA 30 TON

- Capacidade (T): 30.
- Curso (mm): 160.
- Faixa operacional (mm): 166-1126.
- Largura do assento (mm): 540.
- Curso lateral (mm): 200.
- Percurso: 150mm.
- Accionado manual e com pé.



53590

1.190,00€

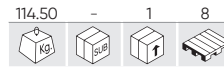

PRENSA HIDRÁULICA 20 TON

- Capacidade (T): 20.
- Curso (mm): 145.
- Faixa operacional (mm): 58-1018.
- Largura do assento (mm): 540.
- Largura interior (mm): 536.
- Curso lateral (mm): 180.



REPOSIÇÕES DISPONÍVEIS

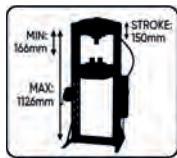

REPOSIÇÕES DISPONÍVEIS

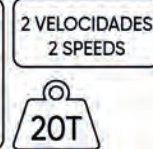
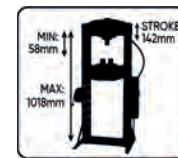

REF. DESCRIÇÃO

14616 GRADE PROTETORA PARA PRENSA HIDRÁULICA 20 T/30 T (REF. 53590/53684)



€

96,00€



52999

178,00€

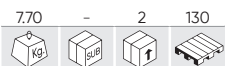

BASE DE TRABALHO PARA PRENSA

BLOCO GRANDE



BLOCO PEQUENO



50827

387,00€

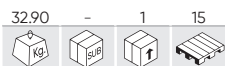

COMPRESSOR DE MOLAS PARA AMORTECEDORES

- Capacidade: 1T (2200 lbs)
- Diâmetro da mola comprimida: 200mm
- Comprimento de compressão: 200-500mm



FERRAMENTAS HIDRÁULICAS

50831

460,00€



GRUA DE 2 TON DOBRÀVEL



52985

598,00€



GRUA DE 1T DOBRÀVEL



50631

68,00€



SUPOORTE ALINHADOR DE MOTOR 750KG



50840

138,00€



SUPOORTE PARA MOTORES 500KG (1750MM)



REF.	DESCRIÇÃO	kg	BOX	UN	€
51452	ENGATE E MANIVELA PARA REF. 50840	3.43	-	1 50	69,00€

53682

98,00€

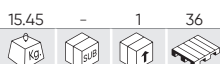

SUPOORTE PARA MOTORES 500KG (1480MM)



52055

139,00€



SUPOORTE DE MOTOR UNIVERSAL



50836

148,00€

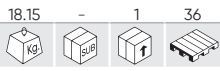

SUPORE PARA MOTORES 340KG



50838

299,00€

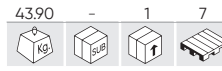

SUPORE PARA MOTORES 900KG



- Dimensão flexada:
1000x500x440mm.



GUINDASTE MANUAL

54262

88,00€

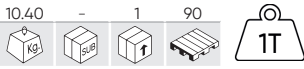

54263

130,00€

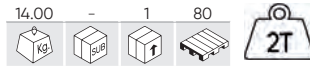

54264

240,00€

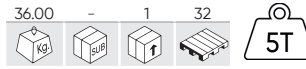

ALTURA DE ELEVACIÓN

54262

2,8m

54263

2,8m

54264

2,8m

Nº DE RAMALES

1

2

2

MEDIDAS PASO CADENA

Cadena de carga: 6x30mm

Cadena manual: 4,5x25mm

LONGITUD

Cadena de carga: 3m

Cadena manual: 2,5m

ESFUERZO PARA CARGA MÁXIMA

304N

310N

361N

MATERIAL

Cadena de carga: Acero 20Mn2

Cadena manual: Acero Q235



52845

170,00€

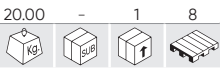

SET DE 2 RAMPA PARA ELEVAR 1 TON

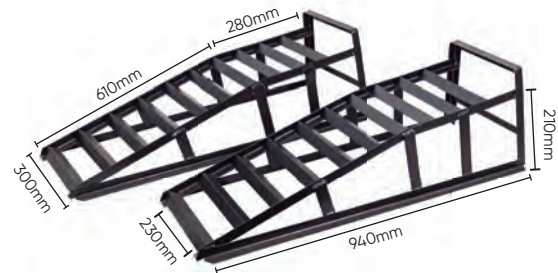

53423

199,00€

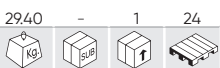

MACACO ELEVAÇÃO QUAD



REPOSIÇÕES
DISPONÍVEIS

53969

96,00€

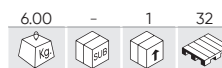

ELEVADOR DE MOTAS



54386

5.839,00€



N

ELEVADOR PARA MONTAGEM DE BATERIAS EM VEÍCULOS ELÉCTRICOS

Este veículo de tipo tesoura eléctrico possui as vantagens de elevação livre, marcha flexível, operação conveniente, estilo bonito e não poluente. Pode ser amplamente utilizado como plataforma de trabalho temporária para manuseamento de bens em oficinas, armazéns, terminais de carga e outros locais pequenos. É uma ferramenta ideal para reduzir a resistência à fadiga, melhorar a eficiência da produção e realizar carregamentos e descarregamentos de maneira segura.

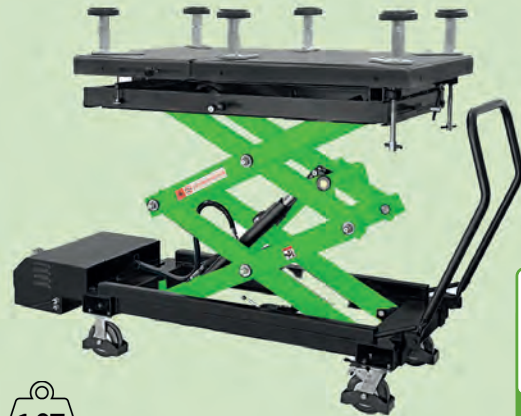

REPOSIÇÕES DISPONÍVEIS

Características de carregamento	Carga distribuída
Tempo de levantamento (sem carga)	60"
Tempo de descida (sem carga)	45"
Plataforma	1290 - 1400x768mm

MAX: 1840mm
MIN: 650mm



52692

129,00€

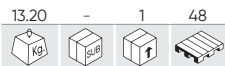

MESA PARA MOTAS



50911

788,00€



MESA HIDRÁULICA PARA MOTAS 365KG



REPOSIÇÕES DISPONÍVEIS

53246

1.144,00€

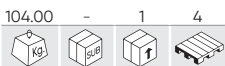

MESA HIDRÁULICA 360KG



50630

590,00€



MESA ELEVADORA PARA MOTAS 400KG



REPOSIÇÕES DISPONÍVEIS

BASE DE ELEVADOR DE GOMA PARA ELEVADOR

<p>54349 8,00€</p> <p>0.48 - 68 -</p> <p>A 160mm B 120mm C 20mm</p>	<p>54350 12,50€</p> <p>0.67 - 48 -</p> <p>A 160mm B 120mm C 30mm</p>	<p>54351 14,00€</p> <p>0.97 - 32 -</p> <p>A 160mm B 120mm C 40mm</p>	<p>54352 18,00€</p> <p>1.43 - 20 -</p> <p>A 160mm B 120mm C 60mm</p>
<p>54353 23,50€</p> <p>1.85 4 12 -</p> <p>A 160mm B 120mm C 80mm</p>	<p>54354 34,50€</p> <p>2.91 - 8 270</p> <p>A 160mm B 120mm C 120mm</p>	<p>54483 14,00€</p> <p>0.70 - 40 -</p> <p>A 160mm B 120mm C 35mm</p>	<p>54484 26,00€</p> <p>1.75 - 20 -</p> <p>A 160mm B 120mm C 70mm</p>
<p>54485 36,00€</p> <p>2.40 - 8 -</p> <p>A 160mm B 120mm C 100mm</p>	<p>54355 12,00€</p> <p>0.20 - 60 -</p> <p>RAVAGLIOLI/SIRIO/SPACE A 123mm D 108mm B 26mm E 10mm C 104mm</p>	<p>54360 14,00€</p> <p>0.19 - 72 -</p> <p>RAVAGLIOLI/SIRIO/SPACE A 130mm D 125mm B 23mm E 10mm C 121mm</p>	<p>54486 9,50€</p> <p>0.10 - 120 -</p> <p>RAVAGLIOLI/SIRIO/SPACE A 100mm D 85mm B 22mm E 8,5mm C 81mm</p>
<p>54488 15,00€</p> <p>0.25 - 40 -</p> <p>RAVAGLIOLI A 150mm D 135mm B 25mm E 10mm C 128mm</p>	<p>54493 13,50€</p> <p>0.20 - 60 -</p> <p>RAVAGLIOLI A 120mm B 110mm C 27mm</p>	<p>54494 14,00€</p> <p>0.30 - 48 1152</p> <p>RAVAGLIOLI A 145mm B 135mm C 26mm</p>	<p>54357 15,00€</p> <p>0.29 - 60 -</p> <p>TWIN BUSCH A 120mm D 105mm B 30mm E 8,5mm C 100mm F 66mm</p>
<p>54358 18,50€</p> <p>0.36 - 44 -</p> <p>TWIN BUSCH A 140mm D 125mm B 25mm E 10mm C 116mm F 66mm</p>	<p>54361 14,00€</p> <p>0.25 - 52 -</p> <p>TWIN BUSCH A 140mm D 125mm B 28mm E 8mm C 120mm</p>	<p>54363 14,00€</p> <p>0.30 - 44 -</p> <p>ISTOBAL/VELYEN A 155mm D 147mm B 24mm E 6mm C 140mm</p>	<p>54365 12,50€</p> <p>0.20 - 108 -</p> <p>ISTOBAL/VELYEN A 145mm B 10mm C 60mm</p>

BASE DE ELEVADOR DE GOMA PARA ELEVADOR

<p>54359 14,00€</p> <p>0.31 - 48 1440</p> <p>OMCN</p> <p>A 140mm B 133mm C 27mm</p>	<p>54491 17,50€</p> <p>0.30 - 44 -</p> <p>OMCN</p> <p>A 145mm B 25mm</p>	<p>54366 18,50€</p> <p>0.30 - 80 -</p> <p>NASSBAUM/AMI</p> <p>A 125mm D 120mm B 24mm C 90mm</p>	<p>54362 14,00€</p> <p>0.25 - 48 -</p> <p>CASCOS</p> <p>A 138mm D 130mm B 25mm E 9mm C 120mm</p>
--	---	--	---

<p>54487 15,00€</p> <p>0.15 - 80 -</p> <p>ROTARY</p> <p>A 123mm D 112mm B 22mm E 8mm C 90,5mm</p>	<p>54495 18,00€</p> <p>0.25 - 108 3240</p> <p>ROTARY</p> <p>A 125mm B 15mm C 90mm</p>	<p>54496 16,50€</p> <p>0.10 - 400 2400</p> <p>ROTARY</p> <p>A 104mm D 80mm B 82mm E 56mm C 8mm</p>	<p>54497 12,50€</p> <p>0.15 - 88 2700</p> <p>MAHA</p> <p>A 120mm D 113mm B 22mm E 8mm C 102mm F 83mm</p>
--	--	---	---

<p>54492 19,50€</p> <p>0.35 - 60 -</p> <p>SLIFT/IME</p> <p>A 125mm D 110mm B 25mm E 9mm C 120mm F 83mm</p>	<p>54356 19,50€</p> <p>0.44 - 48 1152</p> <p>500E/500X/ JEEP RENEGADE</p> <p>A 55mm B 100mm</p>	<p>54364 14,00€</p> <p>0.29 - 52 -</p> <p>LAUNCH/TWIN BUSCH/RP TOOLS</p> <p>A 120mm D 108mm B 32mm C 70mm</p>	<p>54489 19,50€</p> <p>0.35 - 28 -</p> <p>KONI/ROMERICO/CAR-O-LINER</p> <p>A 160mm D 153mm B 29mm E 10mm C 140mm</p>
---	--	--	---

54490 15,00€

0.20 - 88 -

ATH/HOFMANN/
HERMANN/ J.A.B. BECKER

A 120mm D 110mm
B 19mm E 4mm
C 130mm

54175 34,00€

0.80 5 20 360

CONJUNTO DE 4 BASES DE
ELEVÇÃO TESLA

NR TESLA 3/X/S/Y



FERRAMENTAS ELÉTRICAS

- 328 ARRANCADOR
- 329 MANUTENÇÃO DE BATERIAS
- 330 MEDIÇÃO DE CORRENTE
- 332 INSPEÇÃO VISUAL
- 332 SOLDADORA
- 334 EQUIPAMENTO PARA OFICINA
- 337 CLIMATIZAÇÃO
- 338 TERMÓMETROS
- 338 OUTROS



FERRAMENTAS ELÉTRICAS

CABOS DE ARRANQUE

PINÇA MACIÇA DE LATÃO

REF.	Ø CABO	LONGO	A	SECÇÃO					€
51238	17mm	5m	700	70mm ²	4.95	-	2	84	138,00€
51239	15mm	7m	700	70mm ²	5.90	-	2	72	159,00€

PINÇA DE LATÃO

REF.	Ø CABO	LONGO	A	SECÇÃO					€
52069	11mm	2,5m	250	25mm ²	1.55	-	10	240	29,50€
52070	12mm	3m	350	35mm ²	1.95	-	5	160	40,00€
52071	13mm	3m	500	50mm ²	2.35	-	5	90	47,00€

PINÇA MACIÇA DE LATÃO COM PROTETOR DE SOBRECARGA

REF.	Ø CABO	LONGO	A	SECÇÃO					€
51363	12mm	3m	350	35mm ²	2.63	-	5	120	114,00€
51365	12mm	3m	600	50mm ²	3.10	-	5	90	118,00€



REF.	DESCRIÇÃO					€
14145	PINÇA MACISSA DE COBRE	0.20	-	30	-	8,50€
14146	PINÇA MACISSA DE COBRE	0.20	-	30	1920	8,00€
14147	PINÇA MACISSA DE LATÃO	0.35	-	15	-	25,00€
14148	PINÇA MACISSA DE LATÃO	0.35	-	15	-	25,00€

53687

298,00€

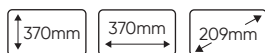
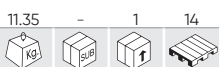

ARRANCADOR DE BATERIA 12V

- Tensão: 12V.
- Bateria: 22Ah, ácido - chumbo (1 unid.)
- Corrente de partida: 750A.
- Corrente de pico: 1500A.

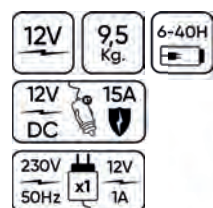

REPOSIÇÕES
DISPONÍVEIS

- A MEDIDOR DE TENSÃO DA BATERIA INTERNA
- B BOTÃO DE VERIFICAÇÃO DA TENSÃO DA BATERIA INTERNA
- C INTERRUPTOR LIGAR / DESLIGAR
- D LUZ LED INTEGRADA: AUMENTA A VISIBILIDADE DA ÁREA DE TRABALHO

53688

495,00€



ARRANCADOR DE BATERIAS 12/24V

- Tensão: 12V/24V.
- Bateria: 22Ah AGM de ácido-chumbo (2 unid.)
- Corrente de partida: 12V: 1500A/3000A.
- Corrente de pico: 24V: 750A/1500A.
- Tempo de carga da bateria: Carga total da bateria: 40 h
- Carga até 10-20%: 6 h

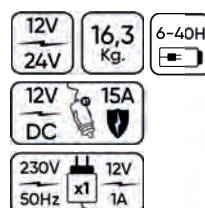

REPOSIÇÕES
DISPONÍVEIS

- A MEDIDOR DE TENSÃO DA BATERIA INTERNA
- B BOTÃO DE VERIFICAÇÃO DA TENSÃO DA BATERIA INTERNA
- C INTERRUPTOR LIGAR / DESLIGAR
- D LUZ LED INTEGRADA: AUMENTA A VISIBILIDADE DA ÁREA DE TRABALHO

51816 58,00€



COMPROVADOR DE BATERIAS DIGITAL

- Aplicável em baterias de 12v.
- Medição em SAE(CCA), EN, IEC, DIN, CA.
- Rango: 200~1200CAA (SAE).
- Medição de voltagem: 7V~15V.
- Display 4 + 3 Leds (verde, vermelho, amarelo).
- 150Ah.



51235 49,00€



COMPROVADOR DE BATERIAS

- Para baterias de 6v e 12v.
- Carga até 100Ah.
- Test de Estado de carga.
- Test de Consumo de Arranque.
- Test de Voltajem da carga.
- Test do estado de la Bateria.



52884 73,00€

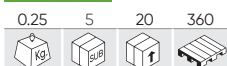

ARMAZENAMENTO DE MEMÓRIA PARA A SUBSTITUIÇÃO DAS BATERIAS

12V

- Útil para manter corrente no sistema eléctrico do veiculo durante troca de bateria.
- Conexão OBDII via cabo ou isqueiro.



53209 8,50€



DENSÍMETRO DE BATERÍAS

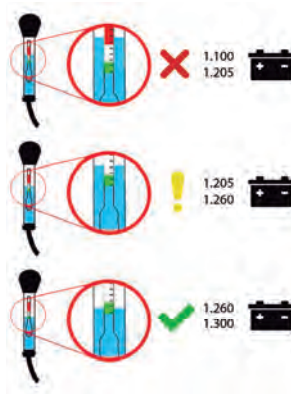

CARREGADORES DE BATERÍA

Compatível com Baterias de chumbo-ácido: líquido, hélio, MF e AGM

53927 66,00€



100V 240V	60W	50-60 HZ
72 VDC 0.9-3.6A	0°C 40°C	
6V 7.2V	12V 14.4V	NORM
6V 7.4V	12V 14.7V	COLD/AGM



53929 95,00€



100V 240V	150W	50-60 HZ
14.7 VDC 3.6-7.2A	-20°C 40°C	
12V 14.4V	24V 28.8V	NORM
12V 14.7V	24V 29.4V	COLD/AGM



FERRAMENTAS ELÉTRICAS

52233

328,00€



COMPROVADOR DE BATERIAS E ALTERNADORES COM IMPRESSORA

- Aplicável a baterias de 6V e 12V.
- Sistemas de carga encendido de 12V e 24V.
- Alcance de operação: 40 - 2000 CCA (SAE).
- Voltímetro: 1.5V - 30V.
- Jogo de cabos de 180cm.
- Inclui: 1 rolo de papel térmico.

AGM, GEL, VRLA, SLI



54040

240,00€

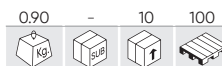

COMPROVADOR DE BATERIA COM IMPRESSORA

- Aplicável a baterias de 12 V, AGM (tapete de vidro absorvente), GEL (gel), VRLA (ácido de chumbo regulado por válvula), SLI (com eletrólito líquido).
- Faixa de operação: 100-2,000 corrente de partida a frio CCA (SAE)
- Idiomas disponíveis do sistema: Espanhol (ES), Inglês (EN), Francês (FR), Alemão (DE), Italiano (IT), Português (PT), Romeno (RO)
- Aplicável para sistemas de partida 12/24 V.
- Aplicável a baterias de 12 V, AGM (tapete de vidro absorvente), GEL (gel), VRLA (ácido de chumbo regulado por válvula), SLI (com eletrólito líquido).
- Testador de arrancadores e alternadores.
- Inclui: Uma bateria CR2032 incluída



REF. DESCRIÇÃO

51842 PAPEL TÉRMICO PARA IMPRESSORA REF. 52233-54040

0.10 6 72 € 6,90€

54256

48,00€

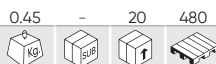

PROTETOR DE PICOS AUTOMÁTICO 12/24V



52231

49,00€

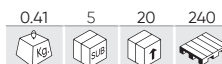

KIT DE ACESSÓRIOS PARA MULTÍMETRO

- Este kit é apto para a maioria de multimetros.

CONTÉM
2 sondas.
2 pinças pequenas.
2 pinças largas.
cabos de extensão.



54114

248,00€



MEDIDOR DE ISOLAMENTO

Categoria de instalação:	2
Categoria de medição:	CAT III
Altitude:	Até 2000 metros
Display	LCD com visor duplo
Tensão AC:	0 - 750V
Tensão DC:	0 - 1000V
Resistência:	0 - 200Ω / 200 - 2000 Ω
Resistência de isolamento:	0 - 200MΩ / 200 - 2000 MΩ
Voltagem de amostragem:	2,5 vezes por segundo
Ajuste zero:	Ajuste automático
Temperatura de funcionamento:	00 - 400C (320F - 1040F), humidade relativa inferior a 80%

Temperatura de armazenamento:	-100C - 600C (140F - 1400F), humidade relativa inferior a 70%
Fonte de potência:	DC9V (pilhas tamanho "AA" 6x1,5V)
Dimensões (comprimento x largura x altura):	200 x 92 x 50mm

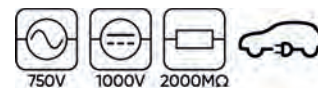

50942

28,00€

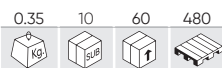

MULTÍMETRO DIGITAL

- Dígitos: 3 1/2.
- Medição: 2 000.
- Dados instantâneos.
- Autoapagado.
- Indicador de bateria.
- Baterias de 9 V.
- Sonda de temperatura.
- Temperatura de -40 °C a 1000 °C.



AC	AC
200mV, 2V, 20V, 200V, 1000V	20mA, 200mA, 20A
DC	DC
200mV, 2V, 20V, 200V, 750V	20mA, 200mA, 20A
Ω	F
200Ω, 2KΩ, 20KΩ, 200KΩ, 2MΩ, 20MΩ, 2000MΩ	2nF, 20nF, 200nF, 2μF, 20μF, 200μF

52439

227,00€

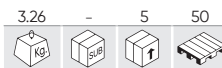

JOGO DE CABOS E ACC PARA MULTÍMETRO

- 2 medidores de resistência variável.
- 2 luzes led de comprovação.
- 2 SRS substituição e dois dispositivos de proba.
- 2 alicates de crocodilo.
- 2 tomas de engate rápido.
- 4 sondas.
- 24 conectores redondos.
- 48 conectores lisos.



52382

19,50€

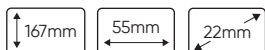
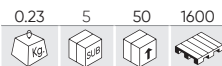

PINÇA AMPERIMÉTRICA

- Instrumento ideal para electricistas.
- Pode-se medir: voltagem AC, voltagem DC, Corrente AC, resistência, diodo, frequência.
- Entorno de funcionamento: 0°C a 40°C, α <80%RH.
- Entorno de armazenagem: -10°C a 40°C, α <85%RH.
- Alimentação: 2 pilhas tamanho AAA.
- Indicador de bateria baixa.
- Écra de 3,5" com 4 dígitos.
- Função de corrente contínua.
- Medição de voltagem AC/DC.



DCB 600V	- FUNÇÕES: Teste fio vivo.
ACB 600V	
DCA -	
ACA 20A, 200A, 600A	
OHM 2KΩ, 200KΩ, 2MΩ	

52952

74,00€

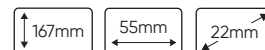
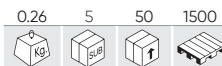

PINÇA AMPERIMÉTRICA PROFESIONAL

- Instrumento ideal para electricistas.
- Pode-se medir: voltagem AC, voltagem DC, Corrente AC, resistência, diodo, frequência.
- Entorno de funcionamento: 0°C a 40°C, α <80%RH.
- Entorno de armazenagem: -10°C a 40°C, α <85%RH.
- Alimentação: 2 pilhas tamanho AAA.
- Indicador de bateria baixa.
- Écra de 3,5" com 4 dígitos.
- Função de corrente contínua.
- Medição de voltagem AC/DC.



DCB 20V, 600V	- FUNÇÕES: Teste fio vivo. Teste de diodo. Teste de continuidade. Função ADP. Função de detecção de fase. Interruptor ZERO.
ACB 600V	
DCA 200A	
ACA 200A	
OHM 2000Ω	

53028

5,80€

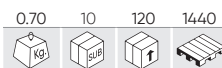

COMPROVADOR DE CIRCUITOS 1,8X190MM

6-12-24V
1,8 x 190mm



- Adequado para verificar a polaridade.

53029

6,80€

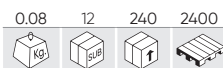

TESTER CIRCUITO AUTOMOTIVE 2X115MM

6-12-24V
2 x 115mm



53030

12,00€

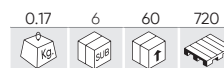

AUTOMOTIVE CIRCUITO TESTER 3X142MM

6-12-24V
3 x 142mm
LED



53724

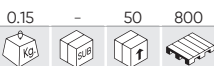

ENDOSCÓPIO COM WIFI

- Endoscópio com função de transferência de imagem Wi-Fi. Capacidade de se conectar a qualquer smartphone. Suporte para trabalhar com um tablet ou computador.

- O pacote inclui: Câmera endoscópica. Transmissor Wi-Fi. Capa de gancho. Capa de imã. Capa de espelho lateral.

CABO SEMI-RÍGIDO DE 1M



Funciona com JBM APP:



46,00€

53484

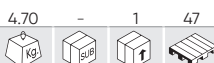

DETECTOR DE VAZAMENTO DE GÁS

- ÓLEO NÃO INCLUÍDO.



CONTÉM



REPOSIÇÕES DISPONÍVEIS

615,00€



53977

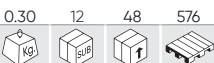

SOLDADOR 40W

- Tensão: 220-240V
- Cable: 1,3 m
- Comprimento: 240mm
- Temperatura máxima de trabalho: 450°+/-10%



17,50€



53111



MAÇARICO DE SOLDA 100W

- Tensão: 220-240V
- Cable: 1,5m.
- Comprimento: 250mm.
- Temperatura máxima de trabalho: 420°C + / - 10%.



19,00€



53145



PISTOLA DE CALOR 2000W

- 220V-240V.
- 50Hz-60HZ.
- 2000W.
- Temperatura de saída: 50-600°C.
- Fluxo de ar: 220-480L/min.
- 2 opções de temperatura: 300 i 600°C.



39,20€

53162



PISTOLA DE CALOR DIGITAL 2000W

- 220V-240V.
- 50Hz-60HZ.
- 2000W.
- Temperatura de saída: 100-600°C.
- Fluxo de ar: 280-480L/min.



60,00€

53981

143,00€

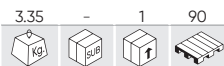

DISPOSITIVO PARA SOLDAGEM A ARCO ELÉTRICO MANUAL COM INVERSOR CC 100 A

CONTÉM

Porta-eletrodo com cabo de 2m.
Pinça de aterramento com cabo de 1,5m.
Escova de martelo.
Máscara facial manual.



- ✓ INVERSOR COM TECNOLOGIA IGBT
- ✓ SOLDAGEM MANUAL DC SOLDAGEM A ARCO
- ✓ PROTEÇÃO CONTRA QUEIMAD+HSURA
- ✓ POTÊNCIA DO ARCO
- ✓ IGNIÇÃO DE ARCO QUENTE



53982

219,00€

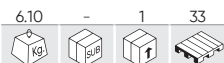

DISPOSITIVO PARA SOLDAGEM A ARCO ELÉTRICO MANUAL COM INVERSOR CC 160 A

CONTÉM

Porta-eletrodo com cabo de 2m.
Pinça de aterramento com cabo de 1,5m.
Escova de martelo.
Máscara facial manual.



- ✓ INVERSOR COM TECNOLOGIA IGBT
- ✓ SOLDAGEM MANUAL DC SOLDAGEM A ARCO
- ✓ PROTEÇÃO CONTRA QUEIMAD+HSURA
- ✓ POTÊNCIA DO ARCO
- ✓ IGNIÇÃO DE ARCO QUENTE



53414

49,00€



CAPACETE PARA SOLDAGEM COM REGULADOR MANUAL



BOTÃO ANALÓGICO PARA AJUSTAR A SENSIBILIDADE E ESCURECIMENTO

53415

188,00€



CAPACETE PARA SOLDAGEM COM REGULADOR DIGITAL



REGULADOR DIGITAL

ESQUADRO MAGNÉTICO 45°, 90°, 135°

REF.	↔	📦	📦	📦	📦	€
54111	75mm	0.35	10	40	1680	4,75€
54113	100mm	0.60	10	20	1100	7,65€



54482

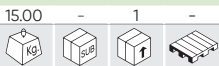

677,00€

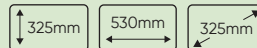

N

LIMPADOR ULTRASSÔNICO 30L

Esta máquina permite-lhe limpar peças através da emissão de ultrassons. É especialmente indicada para limpar peças com formas complexas.

POTÊNCIA DOS ULTRASSONS: 600W	ALIMENTAÇÃO: 200~240V (50HZ)
POTÊNCIA DE AQUECIMENTO: 500W	NÚMERO DE TRANSDUTORES: 10
CAPACIDADE DO DEPÓSITO: 30L	AQUECEDOR: 0~80°C
FREQUÊNCIA ULTRASSÔNICA: 40KHZ	MATERIAL: AÇO INOXIDÁVEL SUS304
TEMPORIZADOR: 1~30 MIN.	DIMENSÕES DO DEPÓSITO: 500x300x200mm



53220

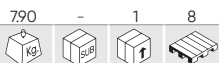

260,00€

MÁQUINA LIMPADORA DE PEÇAS PORTÁTIL

- FORMATO PORTÁTIL.
- Permite o fecho estanque para evitar perdas durante o transporte.
- Usar com solvente de base aquosa.
- Tomada de acendido lateral.
- Filtro de limpeza de líquido incluído.
- Gancho de ferramentas e de mangueira incluído.
- Compartimento de armazenamento.
- Separação de áreas de trabalho, área de limpeza e área de secagem, aceita o trabalho com varias peças a tudo de uma vez.

- Capacidade máxima: 27,5 l.
- Capacidade de bombeamento: 1.000 L/h.
- Capacidade de trabalho: 20L.
- Conexão a 220V.
- Mangueira de 1,10m de longo.



AMOLADORA DUPLA ELÉCTRICA

REF.	W	V/W	RPM	HZ	Ø I	Ø II	Ø III	Icon 1	Icon 2	Icon 3	Icon 4	€
53656	450W	230V/450W	2950RPM	50Hz	Ø 150mm	Ø 20mm	Ø 12,7mm	11.05	-	1	50	198,00€
53657	600W	230V/600W	2950RPM	50Hz	Ø 200mm	Ø 25mm	Ø 15,88mm	16.35	-	1	24	248,00€
53658	250W	230V/250W	2950RPM	50Hz	Ø 150mm	Ø 20mm	Ø 12,7mm	6.95	-	1	60	99,00€
53659	250W	230V/250W	2950RPM	50Hz	Ø 150mm Ø 200mm	Ø 20mm Ø 40mm	Ø 12,7mm Ø 20mm	9.70	-	1	15	121,00€



53656
53657



53658



53659

52195



170,00€

AMOLADORA DUPLA ELÉCTRICA 150MM

- Potência nominal entrada 250w.
- Tensão nominal 230v / 50hz.
- Velocidade sem carga 2950rpm.
- Diâmetro da roda 150 x 20 x 12,7mm



53660

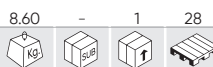

146,00€

BASE METÁLICA PARA AMOLADORA DE BANCADA

- Altura: 790mm.
- Dimensões da placa de fixação: 250x280mm.



54342 858,00€

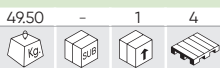

N

MÁQUINA LIMPADORA DE PEÇAS COM TERMÓSTATO



REPOSIÇÕES DISPONÍVEIS

Máquina projetada para a lavagem perfeita de peças sujas. Inclui uma pistola pneumática para limpar com solvente e também pode ser usada para secar as peças com ar comprimido. Graças à cabine fechada, o operador se mantém completamente protegido contra respingos e odores do solvente.

Termostato que permite ajustar o nível de temperatura do líquido de limpeza e da luz no interior do tanque para melhor visualização.

54341 643,00€



N

MÁQUINA DE JACTO DE AREIA 220L



REPOSIÇÕES DISPONÍVEIS

Esta máquina de jateamento de areia é fácil de operar, portátil e proporciona um ambiente seguro e prontidão para funcionamento com materiais abrasivos à sua escolha, com a capacidade de limpar as seguintes peças: peças oxidadas, manchas, etc.

52980 480,00€



150L

MÁQUINA LIMPADORA DE PEÇAS 150L

MEDIDAS TOTALES MÁQUINA



MEDIDAS INTERIORES DEPÓSITO

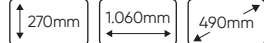

REPOSIÇÕES DISPONÍVEIS

- Caudal: 25L.
- Funciona com soluções de limpeza de motor solúveis em água.

50632 298,00€



100L

MÁQUINA LIMPADORA DE PEÇAS

MEDIDAS TOTALES MÁQUINA

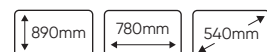

MEDIDAS INTERIORES DEPOSITO

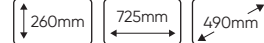

REPOSIÇÕES DISPONÍVEIS

- Caudal: 25L.
- Funciona com soluções de limpeza de motor solúveis em água.

51837

195,00€



ASPIRADOR INDUSTRIAL - SECO DE 30L

30L

Guarnizione	30
Volume de sucção por segundo (l/s)	26
Potência	1x1.200W
Tensão	230V
Frequência	50Hz
Sucção	> 17Kpa
Ø mangueira	32mm
Comprimento da mangueira	1,5m
Comprimento do cabo	4,5m
Vedação	IPx4



CONTÉM



*Esse aspirador conta com um sistema que permite a ligação automática se estiver conectado a um triturador.

REPOSIÇÕES DISPONÍVEIS

51838

667,00€



ASPIRADOR INDUSTRIAL DE 80L (SECO E HÚMIDO)

80L

Guarnizione	80
Volume de sucção por segundo (l/s)	50
Potência	3x1.000W
Tensão	230V
Frequência	50Hz
Sucção	> 20Kpa
Ø mangueira	48mm
Comprimento da mangueira	2m
Comprimento do cabo	4,5m
Vedação	IPx4



CONTÉM



REPOSIÇÕES DISPONÍVEIS

53947

145,00€

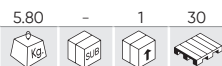

LAVADORA DE ALTA PRESSÃO 1400 W

230V	1400W	MAX 105 Bar	MAX AGUA WATER 50°C	5,0Kg
MAX 6,8L/min	5m	3m	50 Hz	IP X5

CONTÉM



REPOSIÇÕES DISPONÍVEIS

- A PISTOLA DE PULVERIZAÇÃO
- B CABO DE ALIMENTAÇÃO
- C SAÍDA DE AGUA
- D MANGUEIRA DE ALTA PRESSÃO

53948

324,00€



LAVADORA DE ALTA PRESSÃO 2400 W

230V	2400W	MAX 180 Bar	MAX AGUA WATER 50°C	10,0Kg
MAX 8L/min	5m	8m	50 Hz	IP X5

CONTÉM



REPOSIÇÕES DISPONÍVEIS

- A MANGUEIRA DE ALTA PRESSÃO
- B PISTOLA DE PULVERIZAÇÃO
- C SAÍDA DE AGUA
- D CABO DE ALIMENTAÇÃO

53189 128,00€

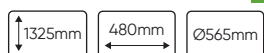

VENTILADOR DE PÉ

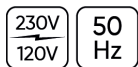

54125 152,00€

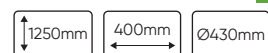

VENTILADOR DE PULVERIZAÇÃO DE ÁGUA

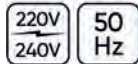

REPOSIÇÕES DISPONÍVEIS



53543 13,80€



VENTILADOR DE VEÍCULO - 12 V



X2 VELOCIDADE



53190 98,00€



VENTILADOR DE CHÃO

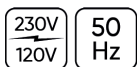

54229 48,00€



AQUECEDOR 2KW



54229
54230

54230 68,00€



AQUECEDOR 3KW



54231 138,00€



AQUECEDOR 5KW



54231
54232

54232 248,00€



AQUECEDOR 9KW



FERRAMENTAS ELÉTRICAS

52162

38,00€

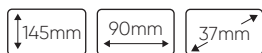
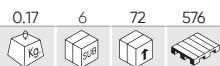

TERMÓMETRO LÁSER -50°C A 550°C

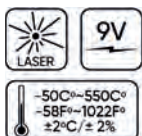

52450

105,00€

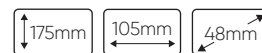
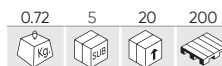

TERMÓMETRO LÁSER -50° ~1000°

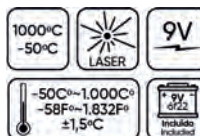

53503

12,00€

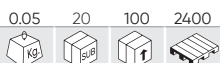

TERMÔMETRO DIGITAL DE CONTATO

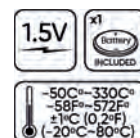

53585

168,00€



CARRETEL DE CABO ELÉCTRICO 21M - AZUL

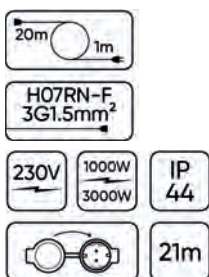

53586

168,00€



CARRETEL DE CABO ELÉCTRICO 21M - VERDE

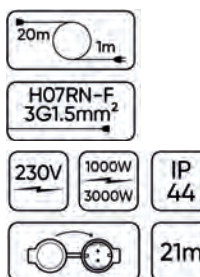

REF. DESCRIÇÃO

14771 SUPORTE DE PAREDE PARA CARRETÉIS DE MANGUEIRA REF. 53532, 53581, 53585, 53586

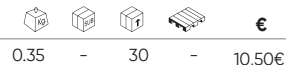

53584

119,00€

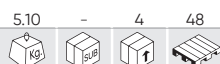

CARRETEL DE CABO ELÉCTRICO - 12M - VERDE

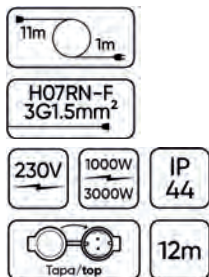

53526

119,00€



CARRETEL DE CABO ELÉCTRICO 12M - AZUL

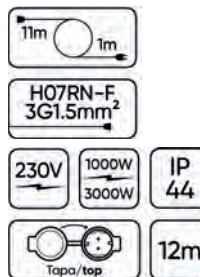

REF. DESCRIÇÃO

14774 SUPORTE DE PAREDE PARA CARRETÉIS DE MANGUEIRA REF. 53526, 53584

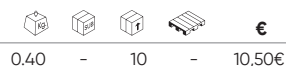

51831 24,00€

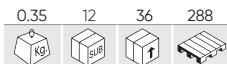

PISTOLA DE COLA TERMOFUSÍVEL

- Voltagem: 100~ 230 V.
- Temperatura: 190~230 °C.
- Consumo: 60~150 W.
- Diâm. de boca: 2.0~2.3 mm.
- Alcance: de 8 a 16g de producto / minuto.



REF.	DESCRIÇÃO					€
51859	BLISTER 10U COLA TERMOFUSÍVEL PARA REF. 51831	0.12	8	32	1520	3,80€

51033 98,00€



EXTENÇÃO MANUAL DE CABO ELÉCTRICO 25M



- Protecção de sobrecarga.
- Protecção infantil.



EXTENSÃO DE CORRENTE ELÉTRICA

REF.	m					€
53166	3m	0.45	5	30	600	10,50€
53167	5m	0.65	5	20	600	12,50€
53168	10m	1.20	-	10	300	19,00€



52643 596,00€



RISCADOR DE PNEUS

REGULÁVEL DIGITALMENTE

REF.	DESCRIÇÃO				€
11974	REPUESTO R1 PARA MÁQUINA PARA RALLAR BORRACHAS REF. 52643	0.01	20	500	1,80€
11975	REPUESTO R2 PARA MÁQUINA PARA RALLAR BORRACHAS REF. 52643	0.01	20	500	1,80€
11976	REPUESTO R3 PARA MÁQUINA PARA RALLAR BORRACHAS REF. 52643	0.01	20	500	1,80€
11977	REPUESTO R4 PARA MÁQUINA DE RALLAR BORRACHAS REF. 52643	0.01	20	500	1,80€
11978	REPUESTO R5 PARA MÁQUINA DE RALLAR BORRACHAS REF. 52643	0.04	20	100	1,80€
11979	REPUESTO W1 PARA MÁQUINA DE RALLAR BORRACHAS REF. 52643	0.04	20	500	1,80€
11980	REPUESTO W2 PARA MÁQUINA DE RALLAR BORRACHAS REF. 52643	0.04	20	500	1,80€
11981	REPUESTO W3 PARA MÁQUINA DE RALLAR BORRACHAS REF. 52643	0.01	20	500	1,80€
11982	REPUESTO W4 PARA MÁQUINA DE RALLAR BORRACHAS REF. 52643	0.01	20	200	1,80€
11983	REPUESTO W5 PARA MÁQUINA DE RALLAR BORRACHAS REF. 52643	0.04	20	500	1,80€



REPUESTOS

REF.	11974	11975	11976	11977	11978
CUTTER TIPO	R1	R2	R3	R4	R5
LÁMINA REDONDA	mm	mm	mm	mm	mm
	A 3	5	6	8	10
	B 7	7	10	12	12
	C 5	8	15	16	18
	D 21	21	23	25	24

REF.	11979	11980	11981	11982	11983
CUTTER TIPO	W1	W2	W3	W4	W5
LÁMINA QUADRADO	mm	mm	mm	mm	mm
	A 3	5	7	9	11
	B 7	7	10	12	12
	C 5	6	10	13	15
	D 21	21	22	24	23

52598

1.080,00€

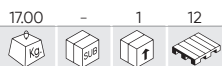

ROBÔ CORTA-RELVA



5200 mAh capacidade da bateria battery capacity	1400m ² área de corte mowing area	IP X4 proteção contra água water protection	DC 15-25,5V tensão de saída output voltage	2,5h tempo de trabalho runtime	22m/min velocidade de corte cutting speed
115,44W consumo de energia power consumption	AC 100-240V 50/60Hz tensão de entrada input voltage	7,5Kg peso weight	2h tempo de carregamento charging time	70 dB(A) nível de ruído noise level	50-35,5-24 cm altura de corte cutting height



CONEXÃO DE APP



- A MOTOR BRUSHLESS
- B BOTÃO STOP
- C ESTAÇÃO DE CARREGAMENTO
- D RODA TRASEIRA
- E TAMPA DA ALÇA

54252

199,00€



VARREDORA DE IMPULSO MANUAL

- A RECIPIENTE DE COLETA DE SUJEIRA
- B CORPO PRINCIPAL
- C ESCOVA DO DISCO ESQUERDO
- D ESCOVA DO DISCO ESQUERDO
- E TAMPA SUPERIOR
- F ALÇA SUPERIOR PARA EMPURRE
- G ALÇA INFERIOR DE EMPURRE
- H ALÇA DE TRANSPORTE

1800 m ² /h área de limpeza cleaning area	200 mm PVC largura da escova brush width	50 mm PVC altura da escova brush height
25L capacidade do recipiente container capacity	Ø 260mm diâmetro do disco disc diameter	650 x15mm tamanho da escova brush size

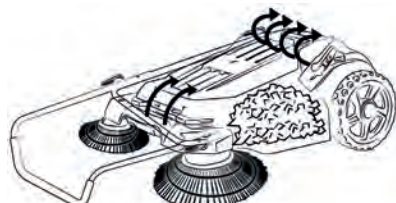

ENERGIA RENOVÁVEL E MOBILIDADE DO FUTURO

342 CABOS PARA CARREGAR DE CARROS ELÉTRICOS

342 CARREGADORES DE CARRO ELÉTRICO

343 GERADOR DE ENERGIA

344 FERRAMENTAS COM ISOLAMENTO



CABO DE CARREGAMENTO

TIPO 1-2 TYPE 1-2

REF.	DESCRIÇÃO					€
54053	CABO DE CARREGAMENTO ELÉTRICO DE CARRO, 3,6KW, 16 A, DO TIPO 1 AO TIPO 2 (SINGLE-PHASE)	2.15	-	5	-	248,00€
54054	CABO DE CARREGAMENTO ELÉTRICO DE CARRO, 7,5KW, 32 A, DO TIPO 1 AO TIPO 2 (SINGLE-PHASE)	2.90	-	5	100	268,00€

-25°
+55°

Tipo
1-2

IP66

5m



TIPO 2-2 TYPE 2-2

REF.	DESCRIÇÃO					€
54055	CABO DE CARREGAMENTO ELÉTRICO DE CARRO, 3,6KW, 16 A, DO TIPO 2 AO TIPO 2 (SINGLE-PHASE)	2.15	-	5	100	220,00€
54056	CABO DE CARREGAMENTO ELÉTRICO DE CARRO, 11KW, 16 A, DO TIPO 2 AO TIPO 2 (TRIFÁSICO)	2.85	-	5	102	260,00€
54057	CABO DE CARREGAMENTO ELÉTRICO DE CARRO, 7,5KW, 32 A, DO TIPO 2 AO TIPO 2 (SINGLE-PHASE)	2.95	-	5	102	248,00€
54058	CABO DE CARREGAMENTO DE CARRO ELÉTRICO, 22KW, 32 A, DO TIPO 2 AO TIPO 2 (TRIFÁSICO)	3.85	-	5	100	348,00€

-25°
+55°

Tipo
2-2

IP66

5m



CARREGADOR DE REDE

REF.	DESCRIÇÃO					€
52600	ESTAÇÃO DE CARREGAMENTO 3,6 KW, 16 A, PARA CARROS ELÉTRICOS (SINGLE-PHASE)	4.65	-	4	80	884,00€
52902	ESTAÇÃO DE CARREGAMENTO 7,5 KW, 32 A, PARA CARROS ELÉTRICOS (SINGLE-PHASE)	4.90	-	4	40	970,00€
52903	ESTAÇÃO DE CARREGAMENTO 11 KW, 16 A, PARA CARROS ELÉTRICOS (TRIFÁSICO)	5.25	-	1	40	1.100,00€

295mm

195mm

65mm

IP66

-25°
+55°

Tipo
2



54265

1.290,00€

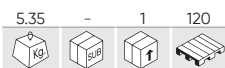

ESTAÇÃO DE CARREGAMENTO 22 KW, 32 A, PARA CARROS ELÉTRICOS (TRIFÁSICO)



Trifásico
Three-Phase



Junte-se ao futuro, com o nosso sistema de carregamento rápido para seu carro elétrico. Design moderno e minimalista. Hoje, com o carregador de parede JBM, você pode transformar a sua garagem, pátio ou estacionamento do escritório em um local fácil de carregar o seu EV / PHEV.

54059

428,00€



ESTAÇÃO DE CARREGAMENTO PORTÁTIL 16A COM CABO DE CARREGAMENTO TIPO 2



Com este carregador móvel, carregue seu veículo onde quer que esteja, com uma tomada normal, sem mais sustos na estrada. Também é uma solução rápida e econômica para carregar carros elétricos em sua oficina. Visor LCD com acesso aos parâmetros mais importantes, cabo tipo 2 integrado, design compacto, carcaça extremamente durável e um cabo de 6 mt. Uma garantia de conforto de uso e confiabilidade.

REF.	DESCRIÇÃO					€
16130	MEDIDOR DE CORRENTE ELÉTRICA PARA CARREGADOR 54265	0.40	-	15	-	290,00€
16198	CARTÃO DE IDENTIFICAÇÃO POR RADIOFREQUÊNCIA (CARTÃO RFID) - 54265	0.01	-	-	-	5,00€

REF.	DESCRIÇÃO					€
15460	CARTÃO DE IDENTIFICAÇÃO POR RADIOFREQUÊNCIA (CARTÃO RFID)	0.01	-	250	-	5,00€

53970

3.790,00€

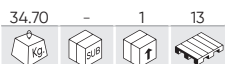

GERADOR DE ENERGIA PORTÁTIL 1920WH/48V 40AH

MPPT	CC-CA	2W(x2) LED	200VAC ±10%	Carga rápida Fast Charging 54V/10A 3-4H	Carga solar Solar Charging 54V/7.5A 4-5H
50-60 Hz	UNIVERSAL	12V 10A			
3000W	Salida nominal de CA Rated AC output	1920Wh LiFePO4			
5000W	Pico de saída de CA Peak AC output	x2000	Ciclos de carga Battery life cycles		
USB-QC 5V 9V/12V/3A	DC(x2) 12V/10A	Temperatura de descarga Discharging Temperature -10°C/60°C	Temperatura de carga Temperature 0°C/45°C		
USB-Type-C 5V/3A - 9V/2A 12V/1.5A	USB 5V 2.4A*2				

A estação de energia portátil é um poderoso gerador elétrico portátil que pode ser carregado com energia solar e, na ausência de luz solar, também pode ser carregado com qualquer fonte de energia.

CONTÉM

- CARREGADOR DE BATERIA
- CARREGADOR SOLAR POR PLACA SOLAR
- CABO DE LIGAÇÃO POR CARREGADOR DE PAREDE

COMPATÍVEL COM **54321**



54321

898,00€



PAINEL SOLAR 200 W



REF.	DESCRIÇÃO					€
15448	CONJUNTO DE 2 CONECTORES MC4 1000V 30A	0.01	-	186	-	5,50€

53940

13,20€



POSTE DE PLÁSTICO PARA CORRENTE - AMARELO / PRETO

- Material: PVC.
- Base infável.

CORRENTE NÃO INCLUÍDA.



ESPECIAL SINALIZAÇÃO DE ALTA TENSÃO



54326

7,30€



N

CORRENTE DE PVC - AMARELO/PRETO 7m



53987

9,50€

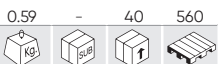

FITA DE SINAL AMARELO/PRETO - 200M

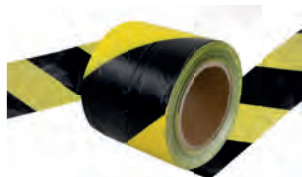

53942

0,50€

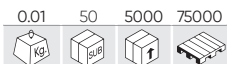

ELO DE FECHAR PRETO



54322

19,00€

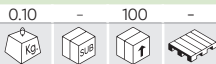

N

CONJUNTO DE 2 SINAIS DE AVISO DE ALTA TENSÃO



52382

19,50€

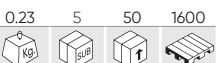

PINÇA AMPERIMÉTRICA

DCB	600V
ACB	600V
DCA	-
ACA	20A, 200A, 600A
OHM	2KΩ, 200KΩ, 2MΩ



52952

74,00€



PINÇA AMPERIMÉTRICA

DCB	20V, 600V
ACB	600V
DCA	200A
ACA	200A
OHM	2000Ω



50942

28,00€



MULTÍMETRO DIGITAL

- Dígitos: 3 1/2.
- Medição: 2 000.
- Dados instantâneos.
- Autoapagado.
- Indicador de bateria.
- Baterias de 9 V.
- Sonda de temperatura.
- Temperatura de -40 °C a 1000 °C.



54091

441,00€



MALETA DE FERREMENTA ISOLADA - 26PEÇAS

26PCS
3/8"
CrV
VDE
GS: Geprüfte Sicherheit
1000V
IEC 60900C



54093

441,00€



MÓDULO EVA DE FERRAMENTA ISOLADA

26PCS
3/8"
CrV
VDE
GS: Geprüfte Sicherheit
1000V
IEC 60900C



53154

462,00€

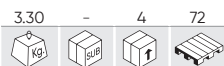

MALETA DE FERRAMENTA ISOLADA 20 PEÇAS DE 3/8"

20PCS
3/8"
CrV
VDE
GS: Geprüfte Sicherheit
1000V
IEC 60900C



15162

30,20€

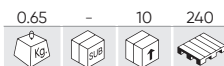

MÓDULO DE FERRAMENTAS VDE EM FIBRA DE CARBONO, BANDEJA DE EVA - 8 PEÇAS

8PCS
VDE
GS: Geprüfte Sicherheit
1000V
IEC 60900C

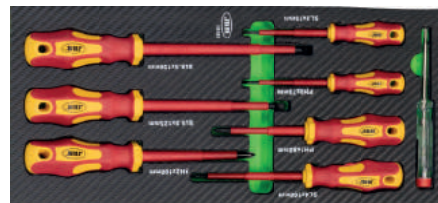

52519

25,50€



KIT DE 7 CHAVES ISOLADAS ATÉ 1.000V

7PCS
CrV
VDE
GS: Geprüfte Sicherheit
1000V
IEC 60900:2004

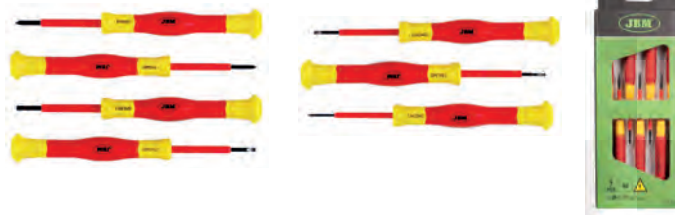

LUVAS ISOLANTES PARA TRABALHOS SOB TENSÃO

REF.	DESCRIÇÃO					€
54130	T.9	0.35	-	1	100	58,00€
54131	T.10	0.40	-	1	100	58,00€

AZC
LATEX
CAT III
CLASS 0
1000V AC / 1500V DC
IEC ELECTRICAL SAFETY
GLOVES 60903-2014 CLASS 0



FACA ISOLADA

REF.	DESCRIÇÃO					€
53164	RETA	0.10	6	36	1152	16,50€
53165	CURVADA	0.10	6	36	1152	19,60€

CrV
VDE
GS: Geprüfte Sicherheit
1000V
IEC 60900C



CARRO DE 7 GAVETAS - ESPECIAL VEÍCULOS ELÉCTRICOS

54236 1.856,00€

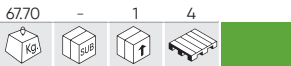

54233 1.856,00€

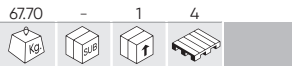

54234 1.856,00€

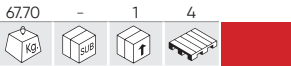

54235 1.856,00€

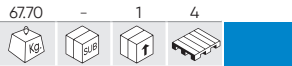

CONTÉM

REF.	UNI.	€	REF.	UNI.	€	REF.	UNI.	€			
A	52162	1	38,00€	E	54093	1	441,00€	I	54132	1	190,00€
B	53940	4	13,20€	F	54114	1	248,00€	J	54241	1	120,00€
C	54326	1	7,30€	G	54129	1	110,00€				
D	53942	8	0,50€	H	54130	1	58,00€				



54386

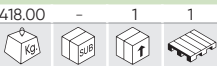

ELEVADOR PARA MONTAGEM DE BATERIAS EM VEÍCULOS ELÉCTRICOS

Características de carregamento	Carga distribuída
Tempo de levantamento (sem carga)	60"
Tempo de descida (sem carga)	45"
Plataforma	1290 - 1400x768mm

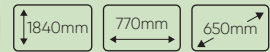

5.839,00€

N



REPOSIÇÕES DISPONÍVEIS

54241

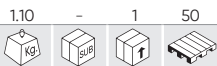

120,00€



GANCHO DE RESGATE ISOLADO - 45KV



54129



110,00€



TAPETE ISOLANTE CLASSE 0

- CLASS 0
- ENROLLABLE ROLLS
- SLIP RESISTANT
- OIL RESISTANT
- RECYCLABLE
- 1000V AC / 1500V DC
- IEC ELECTRICAL SAFETY
- MATTING 60903-2024 CLASS 0

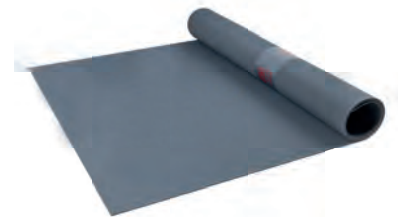

54132

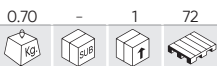

190,00€

PROTEÇÃO FACIAL ISOLANTE PARA TRABALHOS SOB TENSÃO

- ANTI-RALLADURAS / SCRACHING PROOF
- ANTI-VAHO / ANTI FOG
- EN 170:2022
- EN 166:2001
- ANSI Z87.1
- CLASS 1



54114

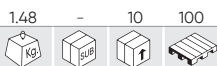

248,00€

MEDIDOR DE ISOLAMENTO

- 2000MΩ
- 1000V
- 750V
- CAT III



ACESSÓRIOS DE OFICINA

348 ENROLADOR DE MANGUEIRA

349 ESCADAS

350 CARRINHOS E PLATAFORMAS



CARRETEL DE MANGUEIRA DE AR

REF.	m					€
53582	22m	10.85	-	1	14	174,00€
53583	22m	10.75	-	1	14	174,00€
53532	13m	6.60	-	2	30	119,00€
53581	13m	6.70	-	2	30	119,00€
53881	11m	4.50	-	4	48	79,00€
53882	11m	4.50	-	4	48	79,00€

300 PSI
20 BAR

3/8"

Ø 9.5mm



COM REPARTIDOR



CARRETEL DE MANGUEIRA DE ÁGUA

REF.	m					€
53872	16,5m	7.50	-	1	21	118,00€

15m + 1,5m

120 PSI
8 BAR

3/4"

Ø 15.8mm
Ø 11.5mm

PVC



REPOSIÇÕES
DISPONÍVEIS



CARRETEL DE CABO ELÉCTRICO

REF.	m					€
53586	21m	8.35	-	2	30	168,00€
53585	21m	8.35	-	2	36	168,00€
53584	12m	5.10	-	4	48	119,00€
53526	12m	5.15	-	4	48	119,00€

230V

1000W
3000W

IP44

H07RN-F
3G1.5mm²



COM REPARTIDOR



CARRETEL DE MANGUEIRA PARA ÓLEO BOCA DE 1/2" 15M

REF.	m					€
50797	16m	26.60	-	1	14	490,00€

- À base de óleo / bobina
- Comprimento da mangueira: 15 + 1 m
- Máx. pressão de trabalho: 2.450 psi
- Entrada de ar: 1/2" BSPT (rosca cônica padrão britânico)
- Saída de ar: 1/2" (rosca cônica padrão britânico)
- Material: aço

160
BAR

ESCADA TELESCÓPICA

REF.	DESCRIÇÃO					€
51982	ESCADA TELESCÓPICA 6 DEGRAUS 2M	5.51	-	1	34	120,00€
51983	ESCADA TELESCÓPICA 10 PASOS 3.2M	9.41	-	1	34	185,00€
51984	ESCADA TELESCÓPICA 12 PASOS 3.8M	9.78	-	1	22	190,00€

CUMPRE COM: EN 131

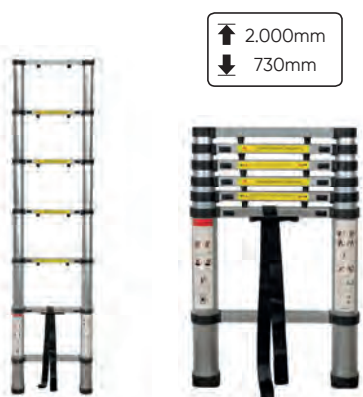

↑ 2.000mm
↓ 730mm

51982

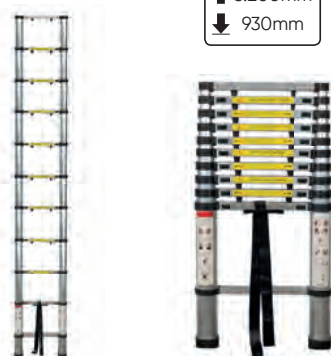

↑ 3.200mm
↓ 930mm

51983



↑ 3.800mm
↓ 1.020mm

51984

52149

14.00	-	1	14
-------	---	---	----



ESCADA TELESCÓPICA EM "V" DOBRÁVEL

- Escada dobrável e leve.
- Sistema de dobrado mediante bloqueio.
- Fabricada em alumínio e plástico.
- Altura fechada: 835mm.
- Altura aberta: 3800mm.
- Alturar dobrada: 1900mm.



230,00€

CUMPRE COM: EN 131

54176

188,00€

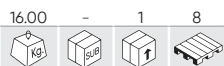

CUMPRE COM: EN 131

ESCADA MULTIFUNÇÕES

- Comprimento máximo: 3,7m
- Capacidade: 150kg
- Material: Alumínio
- Espessura do alumínio: 1,2mm
- Espaço entre dois degraus: 28cm



CONTÉM

REF. DESCRIÇÃO

15866	CONJUNTO DE 2 PLATAFORMAS PARA REF.54176	5.00	-	1	-	32,00€
-------	--	------	---	---	---	--------

50517

129,00€

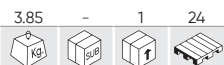

ESCADOTE DE ALUMÍNIO DE 4 DEGRAUS

- 4 DEGRAUS
- Altura total: 1,30m.
- Altura máx. trabalho: 0,79m.



50518

169,00€



ESCADOTE DE ALUMÍNIO DE 6 DEGRAUS

- 6 DEGRAUS
- Altura total: 1,91m.
- Altura máx. trabalho: 1,31m.



52230

398,00€



CUMPRE COM: EN 131

PLATAFORMA DE ALUMÍNIO TELESCÓPICA



MIN			MAX		
520mm	1090mm	300mm	900mm	1750mm	300mm

REF. DESCRIÇÃO

10964	PROTECTOR DE ESQUINAS PARA PLATAFORMA COM REF. 52230	0.01	-	1	-	9,00€
10965	TIPO DE ESCADA PARA PLATAFORMA COM REF. 52230	0.01	-	1	-	6,00€
10966	PÉ DE RECAMBIO PARA PLATAFORMA COM REF. 52230	0.06	-	1	-	13,50€

50656

290,00€

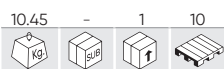

CUMPRE COM: EN 131

JOGO 2 PLATAFORMAS DE ALUMÍNIO



REF.	cm					€
11897	100x30x30cm	4.66	-	1	16	155,00€
15552	130x30x55cm	6.80	-	1	18	181,00€

50913

195,00€

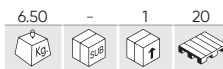

CUMPRE COM: EN 131

PLATAFORMA DE ALUMÍNIO GRANDE



52202

88,00€

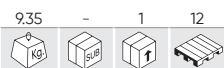

CARRINHO DE MÃO 2 RODAS BASICO DE AÇO CAP.200KG



REF.	DESCRIÇÃO					€
12055	RODA	1.11	10	160	20,00€	

50924

342,00€



CARRO PORTA BIDÕES

200L



52200

88,00€

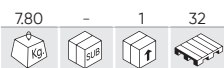

CARRINHO PLATAFORMA DE AÇO CAP. 130KG



ABERTO FEXADO



54305

232,50€



N

CARRO DOBRÁVEL PLATAFORMA ALUMÍNIO 300KG

ABERTO FEXADO



54308

89,00€



N

CARRINHO DE MÃO DOBRÁVEL ALUMINIO 90KG



ABERTO

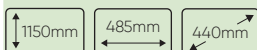

FEXADO

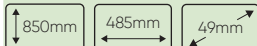

54310

57,00€



N

CARRINHO DE MÃO DOBRÁVEL ALUMINIO 75KG

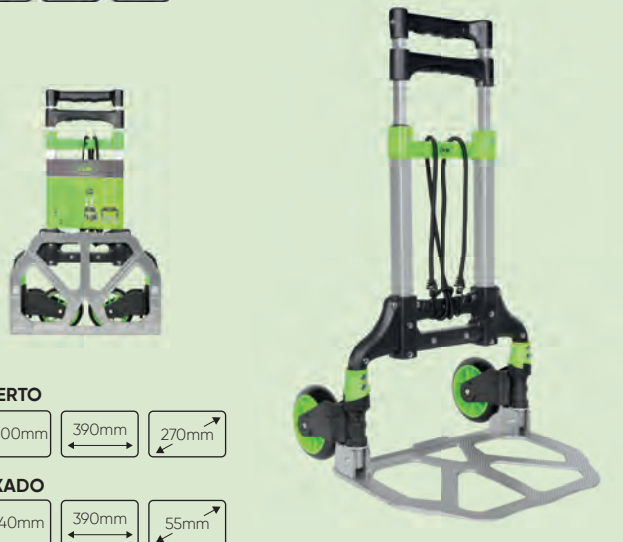

ABERTO

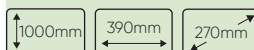

FEXADO

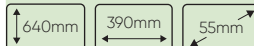

54306

219,50€

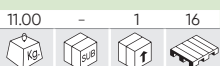

N

CARRINHO DE MÃO DOBRÁVEL ALUMINIO 250KG



ABERTO

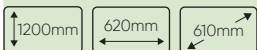

FEXADO



54309

71,00€



N

CARRINHO DE MÃO DOBRÁVEL SOBE ESCADAS

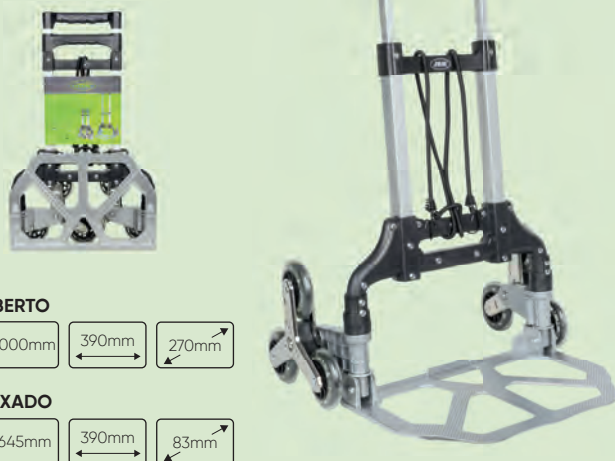

ABERTO



FEXADO



ACESSÓRIOS DO VEÍCULO

- 354 SINALIZAÇÃO
- 355 KITS DE EMERGÊNCIA
- 357 LÂMPADAS
- 358 KITS DE PRIMEIROS SOCORROS
- 359 SEGURANÇA
- 359 CONJUNTOS DE FOLES E ABRAÇADEIRAS
- 361 TAPETES
- 362 LIMPADORES DE PARA-BRISAS
- 363 BICICLETA
- 364 OUTROS
- 366 SENSORES DE ESTACIONAMENTO
- 366 TUBOS FLEXÍVEIS



ACESSÓRIOS DO VEÍCULO

53778

4,50€

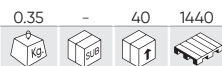

TRIÂNGULO DE SINALIZAÇÃO HOMOLOGADO 27R032736



CUMPRE COM: E4 27R-032736

52795

5,80€



TRIÂNGULO DE SINALIZAÇÃO HOMOLOGADO 27R032738



CUMPRE COM: E4 27R-032738

54298

7,50€



2 TRIÂNGULO DE SINALIZAÇÃO HOMOLOGADO 27R032736



CUMPRE COM: E4 27R-032736

N

KAMIZELKA ODBLASKOWA

CUMPRE COM: EN ISO20471:2013

+A1:2016

51817

4,50€

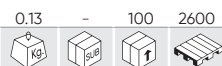

Banda marcada

50654

4,00€



50966

4,00€

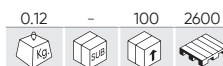

50966C

3,00€



N

FITA REFLEXIVA DE MARCAÇÃO PARA VEÍCULOS DE MERCADORIAS

REF.					€
51935		1.04	10	280	135,00€
51936		1.04	10	140	135,00€
51937		1.02	10	280	135,00€

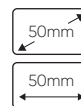
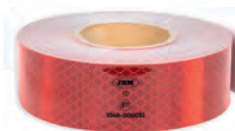
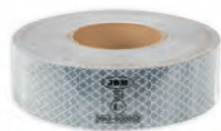

Homologação: REGLAMENTO CEPE/ONU 104R

- Aplicação a partir de 10 julho 2011 segundo modificação do Regulamento General de Vehiculos, aprovado pelo Real Decreto 2822/1998, de 23 Dez. 2010.
- Disponível em amarelo, vermelho e branco.

CHAPA DE SINALIZAÇÃO V-20 "CARGA SUPERDIMENSIONADA"

REF.					€
53636	FEITO DE POLIPROPILENO PARA UMA MAIOR FLEXIBILIDADE	0.87	25	700	22,00€
53507	FRENTE EM POLIMETILMETACRILATO (PMMA) E TRASEIRA EM ALUMÍNIO	0.75	25	800	27,00€



KIT EMERGÊNCIA

ESTOJO CON RIBETE

REF.						€
51692	550x90x130mm	0.11	-	100	1600	3,55€
51693	550x90x130mm	0.12	-	100	1200	3,55€
51694	550x90x130mm	0.14	-	100	1200	3,55€
51696	550x90x130mm	0.12	-	80	1200	3,55€



SACO PRETO COM RIBETE

REF.						€
11328	557x110x70mm	0.12	-	100	1200	4,00€



53721 18,80€

0.16	20	80	1440

BALIZA DE EMERGÊNCIA LED

x24 LED
12W
24H

x9 LED
1.8W
5H

V16

360°

EM EXPOSITOR DE 20 UDS

ESTOJO MINI

REF.						€
53621	550x150mm	0.05	-	100	3200	2,50€
53622	550x150mm	0.05	-	100	3200	2,50€
53623	550x150mm	0.05	-	100	3200	2,50€
53624	550x150mm	0.05	-	100	3200	2,50€



ESTOJO PRETO DE NYLON

REF.						€
15619	330x100x80mm	0.09	-	100	1500	4,00€



N

KIT EMERGÊNCIA

REF.						€
54534	330x100x80mm	0.37	-	10	200	24,00€

COLOQUE SEU LOGO

N

KIT EMERGÊNCIA ESTOJO PVC

REF.							€
53185	x1	0.69	-	10	200	13,20€	
53186	x2	1.04	-	10	200	13,20€	

* Duplo triângulo, obrigatório só em Espanha.

COLOQUE SEU LOGO

KIT EMERGÊNCIA

REF.		△					€	
52768	■	x2	MK H1	1.81	-	10	200	13,80€
52772	■	x2	MK H1	1.88	-	10	200	13,90€
52776	■	x2	MK H1	1.81	-	10	200	13,80€
52780	■	x2	MK H1	1.94	-	10	200	13,90€
52769	■	x2	MK H4	1.01	-	10	200	14,50€
52773	■	x2	MK H4	1.01	-	10	200	14,60€
52777	■	x2	MK H4	1.07	-	10	200	15,50€
52781	■	x2	MK H4	1.14	-	10	200	14,60€
52770	■	x2	MK H7	2.55	-	10	200	23,00€
52774	■	x2	MK H7	0.99	-	10	200	14,80€
52778	■	x2	MK H7	0.99	-	10	200	14,60€
52782	■	x2	MK H7	1.11	-	10	200	14,80€
52771	■	x2	MK H7+H1	2.75	-	10	200	23,40€
52775	■	x2	MK H7+H1	1.01	-	10	200	15,20€
52779	■	x2	MK H7+H1	1.13	-	10	200	17,10€
52783	■	x2	MK H7+H1	1.01	-	10	200	15,20€



H1 (12V)
H4 (12V)
H7 (12V)

* Duplo triângulo, obrigatório só em Espanha.

KIT EMERGÊNCIA ESTOJO BORDA

REF.		△				€	
53177	■	x1	0.63	-	10	200	11,90€
53178	■	x1	0.64	-	10	200	12,20€
53179	■	x1	0.65	-	10	200	12,20€
53180	■	x1	0.63	-	10	200	12,20€
53181	■	x2	0.98	-	10	200	11,90€
53182	■	x2	0.99	-	10	200	12,20€
53183	■	x2	0.99	-	10	200	12,70€
53184	■	x2	0.98	-	10	200	12,20€



COLOQUE SEU LOGO

* Duplo triângulo, obrigatório só em Espanha.

KIT EMERGÊNCIA ESTOJO CON RIBETE

REF.		△				€	
53087	■	x1	0.58	-	10	200	11,20€
53088	■	x1	0.59	-	10	200	11,50€
53089	■	x1	0.61	-	10	200	11,50€
53090	■	x1	0.59	-	10	200	11,50€



COLOQUE SEU LOGO

KIT EMERGÊNCIA ESTOJO MINI

REF.		△				€	
53091	■	x1	0.52	-	10	200	10,20€
53092	■	x1	0.52	-	10	200	10,20€
53093	■	x1	0.52	-	10	200	10,20€
53094	■	x1	0.52	-	10	200	10,20€



COLOQUE SEU LOGO

MINI ESTOJO DE LÂMPADA

REF.								€
51613	12V	H1	0.90	10	100	1500		2,90€
51615	12V	H9	0.09	10	100	1500		5,95€
51612	12V	H11	0.09	10	100	1500		5,95€
50523	12V	HB3	0.09	10	100	1500		4,70€
50524	12V	HB4	0.09	10	100	1500		4,70€
50915	12V	H7+H1	0.10	10	100	1800		4,20€
51614	12V	H4	0.10	10	100	1800		3,60€
50431	12V	H7	0.08	10	100	1800		3,80€
52047	24V	H4	0.09	10	100	1500		3,30€
52048	24V	H7	0.10	10	100	1500		3,95€



50551

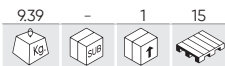

350,00€

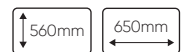

ARMÁRIO DE LÂMPADAS PARA TURISMOS

STOP DE 1 POLO
P21W 21 W BA15S 30U.
P21WA 21 W BA15S AMBAR / 10U.
PY21W 21 W BAU15S
COM DESC. / 10U.

STOP DE 2 POLOS
R21/5 W 21/5 W BAY15D 40U.
PLAFONIER
C5W 5 W SV8.5 11X38 22U.

LÂMPADAS PILOTO
R5W 5 W BA15S 30U.
R10W 10 W BA15S 30U.

LÂMPADAS INDICADORAS
T4W 4 W BA9S 22U.

LÂMPADAS HALÓGENAS
H1 55 W P14.5S 10U.
H2 55 W X511 4U.
H3 55 W PK22S 4U.
H4 60/55 W P43T 10U.
H7 55 W PX26D 10U.
HB3 65 W P20D 4U.
HB4 55 W P20D 4U.
H9 65 W PGJ19-5 4U.
H11 65 W PGJ19-2 4U.

FOCO EUROPEU
T5 1,2 W W2.1X4,6D 20U.
T10 5 W W2.1X9,6D 12U.
T10 3 W W2.1X9,6D 12U.
T13 10 W W2.1X9,6D 10U.
T15 18 W W2.1X9,6D 10U.
T20 21 W W5X16D 10U.
T20A 21 W W5X16D AMBAR 10U.
T20 21/5 W W5X16D 10U.



LÂMPADAS OBN

REF.	DESCRIÇÃO						€
52365	LÂMPADA OBN H7 55W	0.02	10	200	9000		2,46€
52364	LÂMPADA OBN H1 55W	0.02	10	200	4400		2,86€
52362	LÂMPADA OBN H1 55W	0.01	10	200	14400		1,23€
10766	LÂMPADA DE RECAMBIO PARA REF.51960, 51962	0.01	-	200	-		1,59€
52363	LÂMPADA OBN H3 12V 55W	0.02	10	200	14400		1,23€
53203	LAMPADA OBN AMBAR 12V 21W BA15S	0.01	10	200	-		0,46€
52369	LAMPADA OBN 2 POLOS 12V 21/5W	0.01	10	1000	18000		1,19€
52368	LÂMPADA OBN 12V 21W SIN CASQUILHO T20A	0.01	10	1000	18000		1,14€
53007	LÂMPADA OBN R5W 12W 5V	0.05	10	200	1500		0,42€
52862	LÂMPADAS OBN WEDGE 21W 12V T20	0.01	10	1000	1500		1,15€
52370	LÂMPADA OBN AMBAR 12V 21W SEM CASQUILHO T20	0.01	10	1000	18000		1,17€
52864	LÂMPADAS OBN WEDGE 21/5W 12V T20	0.01	10	500	1500		1,20€
52865	LÂMPADAS OBN WEDGE 10W 12V T13	0.01	10	2000	-		0,50€
52866	LÂMPADAS OBN WEDGE 18W 12V T15	0.01	10	2000	256000		0,25€



54042



13,00€

44
PCS

BOLSA DE PRIMEIROS SOCORROS DIN13164:2022

- x1 Fita adesiva DIN13019-A 5x2,5
- x4 Fitas adesivas din 13019-e 10x6
- x2 Adesivos elásticos para os dedos 4x7 cm
- x2 2 Adesivos elásticos para os dedos 12x2 cm
- x2 Tiras de fita adesiva à prova d'água 1,9x7,2 cm
- x4 Tiras de fita adesivas à prova d'água 2,5x7,2 cm
- x1 Bandagem estéril DIN 13151-K 6x8 cm
- x2 Bandagens estéreis DIN 13151-M 8x10 cm
- x1 Bandagem estéril DIN 13151-G 10x12 cm
- x1 Bandagem de primeiros socorros DIN 13152-BR 60x40 cm
- x1 Bandagem de primeiros socorros DIN 13152-A 60x80 cm
- x2 Bandagens estéreis DIN 61634FB6 6 cm x 400 cm
- x3 Bandagens estéreis DIN 61634FB6 8 cm x 400 cm
- x1 Manta de resgate 160x210 cm



- x6 Compressas estéreis para feridas 10x10 cm
- x2 Bandagens triangulares DIN 13168-D
- x1 Tesoura DIN 58279-A145 145 cm
- x4 Luvas descartáveis din em 455-1
- x2 Lenços umedecidos para limpar pele
- x1 Lista de conteúdos
- x1 Guia de primeiros socorros

51246



6,40€

11
PCS

BOLSA DE PRIMEROS SOCORROS

- x1 Folha de primeiros socorros
- x1 Tesoura
- x1 Par de luvas
- x2 Toalhetas de álcool
- x2 Pensos para cortes
- x1 25gr. De algodão
- x1 Pensos para queimaduras
- x1 Liga
- x1 Rolo adesivo



54072



38,50€

67
PCS

MALETA DE PRIMEIROS SOCORROS DIN13157

- x1 Gesso adesivo 5 x 25 - DIN13019-A
- x1 Conjunto de bandagens adesivas 10 x 6 cm (8 unid.) - DIN13019-E
- x6 Remendos de dedo 4 x 6,5 cm
- x6 Remendos de dedo 120 x 20 mm
- x6 Remendos de dedo 7,2 x 1,9 cm
- x12 Remendos de dedo 25 x 72 mm
- x1 Conjunto de bandagens de primeiros socorros 6 x 8 cm - DIN13151-K
- x3 Conjuntos de bandagens de primeiros socorros 8 x 10 cm - DIN13151-M
- x1 Conjunto de ataduras de primeiros socorros 10 x 12 cm - DIN13151-G
- x1 Compressa estéril (curativo de tratamento de queimadura) 60 x 80 cm - DIN13152-A
- x3 Curativos esterilizados (compressas) 100 x 100 mm, 2 unidades / bolsa - DIN58953-2
- x2 Tapa-olhos - 55 mm x 75 mm 1,5 g
- x1 Compressa fria para tratamento de emergência, min. 200 Cm2
- x1 Manta de primeiros socorros, 160 x 210 cm, 12 microns
- x2 Bandagens elásticas (gaze), 6 cm por 400 cm - DIN61634 FB6
- x2 2 Bandagens elásticas (gaze), 8 cm por 400 cm - DIN61634 FB8
- x2 Bandagens triangulares 96x96x136 cm - DIN13168-D
- x1 Tesoura de metal 190 mm - DIN58279-B190
- x2 Sacos de plástico para lixo, 300 x 400 mm, 45 microns
- x5 Materiais não tecidos 20 x 30 cm, min. 15 G/h9m2
- x1 Luvas descartáveis de pvc l-aql1.5 (Conjunto de 4) - DIN EN 455-1



- x1 Livro de informações
- x2 Máscaras cirúrgicas DIN EN 14683
- x4 Toalhetes de limpeza de pele saudáveis

50644 11,60€

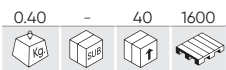

CINTO DE SEGURANÇA DE 2 PONTOS PARA AUTOCARROS

1250mm



CUMPRE COM: E4-16R-0436213

50717 21,90€

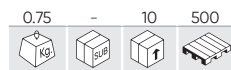

CINTO DE SEGURANÇA DE 2 PONTOS ENROLÁVEL PARA AUTOCARROS

1330mm



CUMPRE COM: E4-16R-0436232

51266 28,00€

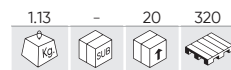

CINTO DE SEGURANÇA DE 3 PONTOS ENROLÁVEL PARA AUTOCARROS

2900mm



CUMPRE COM: E4-16R-0436232

52259 3,75€

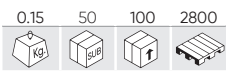

MARTELO DE JANELA DO CARRO COM SUPORTE E CORTADOR DE CINTOS DE SEGURANÇA

135mm
20mm
75mm
Ø 160mm



51861 199,00€

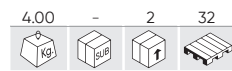

MÁQUINA PNEUMÁTICA P/MONTAR FOLES DE TRANSMISSÕES

125 PSI
9 BAR

- Material: Alumínio.
- Abertura de 20 a 100mm.



ABRAÇADEIRAS

REF.	DESCRIÇÃO					€
11890	ABRAÇADEIRA 50-125MM	0.01	100	1000	18000	0,55€
11891	ABRAÇADEIRA 15-45MM	0.01	100	5000	90000	0,50€
52633	PACK DE 2 ABRAÇADEIRAS	0.02	100	800	14400	1,00€



KIT DE FOLES DE TRANSMISSÕES

REF.	DESCRIÇÃO				€
51703	KIT DE FOLES DE TRANSMISSÕES P/CARRINHAS	0.28	20	320	10,50€
51705	KIT DE FOLES DE TRANSMISSÕES P/TURISMO	0.23	20	400	8,45€



ACESSÓRIOS DO VEÍCULO

52644

0.19 - 20 400

KIT DE FOLE DE TRANSMISSÕES UNIVERSAL



8,80€

53693

19.80 - 1 20

KIT DE 100 FOLE DE TRANSMISSÕES

521,00€



x100 **52633**

x100 **13738**

x100 **13879**

53698

19.80 - 1 24

KIT DE 100 FOLE DE TRANSMISSÃO PARA FURGONETA

717,00€



x100 **52633**

x100 **13739**

x100 **13880**

53695

11.25 - 1 24

KIT DE 80 FOLE DE TRANSMISSÃO UNIVERSAL

504,00€



x80 **52633**

x80 **13740**

x80 **13880**

SERIE124

22.15 - - 20

SÉRIE PROMOCIONAL ESPECIAL KIT FOLE

710,00€



x1 **51861**

x100 **52633**

x100 **13738**

x100 **13879**

PEÇAS DE REPOSIÇÃO

REF.	DESCRIÇÃO					€
13738	FOLE EIXO TURISMO UNIVERSAL	0.08	-	150	1800	3,50€
13739	FOLE EIXO FURGONETA UNIVERSAL	0.15	-	100	1600	5,50€
13740	FOLE EIXO DIREÇÃO UNIVERSAL	0.10	-	72	-	5,50€
13879	SAQUETA GORDURA FOLE TRANSMISSÃO	0.09	-	150	5250	1,38€
13880	SACO DE LUBRIFICAÇÃO DO SISTEMA DE DIREÇÃO	0.01	-	600	21000	1,50€

50585

14,70€

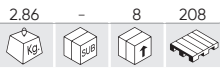

TAPETE DE BORRACHA UNIVERSAL - REVERSIBLE

- Borracha de alta qualidade.
- Muito resistente.
- Adaptável à maioria de veículos.

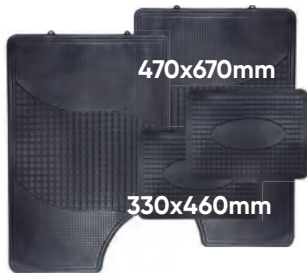

REVERSIBLE!



53241

9,00€

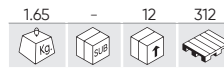

TAPETE DE BORRACHA UNIVERSAL

- Borracha de alta qualidade.
- Muito resistente.
- Adaptável à maioria de veículos.



52534

15,00€



TAPETE DE TELA UNIVERSAL COM TALONERA BORRACHA

REVERSO



- 2 frente (425x660mm) + 2 traseiras (295x425mm).
- Leve, confortável, com salto.
- Reverso com pregos de borracha.



52535

16,50€



TAPETE DE TELA UNIVERSAL + TALONERA TELA

REVERSO

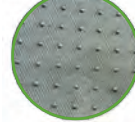

- 2 frente (425x660mm) + 2 traseiras (295x425mm).
- Leve, confortável, com salto.
- Reverso com pregos de borracha.



52530

14,00€



TAPETE DE TELA UNIVERSAL

- 2 frente (390mm) + 2 traseiras (365x480mm).
- Apresentação: Cabide.
- Leve, confortável, com salto.
- Reverso com pregos de borracha.

REVERSO

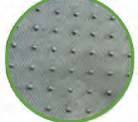

METEXP

62,00€



EXPOSITOR PARA TAPETE



ACESSÓRIOS DO VEÍCULO

LIMPADOR DE PARA-BRISA



99%

Fácil instalação do adaptador em mais de 99% dos veículos.

38dB

A ergonomia e a eliminação de peças de peso reduzem o ruído em 38db.

30%

Pressão uniforme em todo o comprimento da escova, graças à mola de aço para maior visibilidade do que os pincéis originais e desempenho superior de 30%.

100%

100% de borracha natural resistente a todas as condições climáticas extremas.

160km/h

Projeto aerodinâmico que permite o uso até 160 km/h.

45°

Ângulo de corte de 45° e precisão da limpeza transversal que elimina o maior número de quedas de gotas a mais.

REF.	"	mm					€
53745	11"	280mm	0.20	10	50	800	6,40€
53746	12"	310mm	0.20	10	50	800	6,40€
53747	13"	330mm	0.20	10	50	900	6,40€
53748	14"	350mm	0.20	10	50	800	6,60€
53749	15"	380mm	0.20	10	50	900	6,70€
53750	16"	410mm	0.20	10	50	900	6,70€
53751	17"	430mm	0.20	10	50	900	6,80€
53752	18"	460mm	0.25	10	50	800	6,95€
53753	19"	480mm	0.25	10	50	700	7,10€
53754	20"	510mm	0.25	10	50	900	7,40€
53755	21"	530mm	0.25	10	50	600	7,50€
53756	22"	560mm	0.25	10	50	600	7,90€
53757	24"	610mm	0.25	10	50	600	7,90€
53758	26"	650mm	0.30	10	50	600	8,20€
53759	28"	700mm	0.30	10	50	550	8,50€
53760	30"	750mm	0.30	10	50	500	9,60€

11 ADAPTADORES DIFERENTES: PARA VÁRIOS APLICATIVOS



JBMWBEXP

24,50€

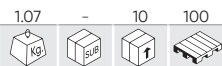

EXPOSITOR ESCOVAS DE LIMPA VIDROS OBN



53919

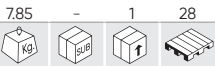

81,00€



SUPOORTE DE REPARO DE BICICLETAS

- Material: aço Q195, ABS, nylon
- Dimensões montadas: 198x104 cm
- Altura ajustável: 107-188 cm
- Comprimento do tubo transversal giratório: 37 cm
- Comprimento do suporte: 69 cm
- Diâmetro do tubo transversal giratório: 35 mm
- Diâmetro do tubo telescópico: 35 mm
- Diâmetro do tubo principal: 38 mm
- Diâmetro do tubo de suporte: 25 mm
- Capacidade máxima de levantamento: 30 kg

DE MATERIAL REFORÇADO ABS E DE NYLON PARA GIRAR A BICICLETA EM QUALQUER ÂNGULO E SEM DANIFICAR A PINTURA.

DIMENSÕES DA BANDEJA MULTIFUNCCIONAL DE FERRAMENTAS 25X13CM

DESIGN ANTIDERRAPANTE 4 PÉS



Para todos os tipos de bicicletas cidade / estrada / montanha



Haste ajustável de fixação: 50-90cm

54166

32,40€

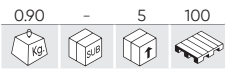

BOMBA DE PÉ PARA PNEUS DE BICICLETA



54170

16,50€

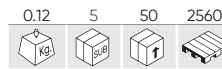

BOMBA DE MÃO PORTÁTIL PARA BICICLETA



54073

70,00€

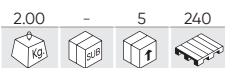

CONJUNTO DE FERRAMENTAS PARA BICICLETA - 20 PÇS



54074

18,50€



FERRAMENTA MULTIFUNCCIONAL DE REPARO DE BICICLETAS



54169

13,80€



CADEADO DE COMBINAÇÃO PARA BICICLETA



ACESSÓRIOS DO VEÍCULO

51858 15,00€

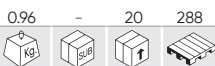

PÁ DOBRÁVEL

- Fabricado com metal resistente.
- Fexada: 240mm.
- Aberta: 580mm.



53033 21,50€

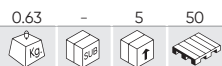

PÁ COM CABO EXTENSÍVEL

- Fabricado com plástico e alumínio.
- Fexada: 85mm.
- Aberta: 119mm.



52187 21,80€



PÁ METÁLICA COM CABO DE MADEIRA DE 215MM



52251 21,80€

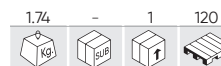

PÁ COM CABO DE MADEIRA DE 215MM



53964 9,65€

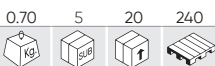

CORDA MULTIUSOS 30M 1/4"

ø 1/4"
550Kg



53965 25,80€

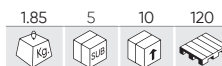

CORDA MULTIUSOS 30M 1/2"

ø 1/2"
1200Kg



51412 2,10€

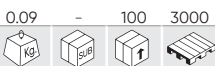

PORTA-PLACA DE MATRICULA ANÔNIMA

- Medidas : 53,20 cm x 13,70 cm.
- Área de escrita : 52 cm x 1,60 cm.

FOTOLITO E TELA NÃO INCLUI



51697 0,80€



ESPÁTULA TIRA GELO



50526 4,80€

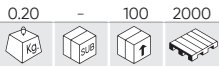

GUARDA-CHUVA DOBRÁVEL



50525 1,00€

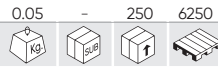

CAPA IMPERMEÁVEL



51925 1,00€

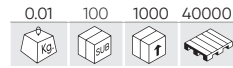

TESOURAS MINI DE 9 CM



52618 29,00€



SET ORGANIZADOR DE MALETERO MULTIFUNCIONAL

- Cofre flexível com tampa 37l (300mm x 490mm).
- Bidon circular 180mm de Ø. com tampa (230mm altura).
- Suporte porta objectos (90mm altura x 260mm amplo).
- Bandeja rígida (175mm altura x 300mm larg).



53221 4,75€

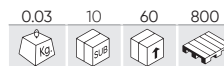

JOGO DE 3 CAMURÇAS DE MICROFIBRAS

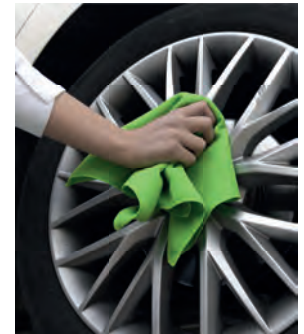

53561 28,00€

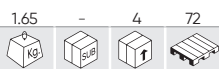

CALÇO DE RODA

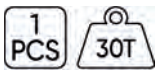

53508 14,00€

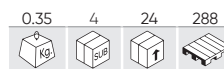

CALÇOS DE RODA



REF.	DESCRIÇÃO					€
14118	SUPOORTE DE CALÇO DE RODA	1.25	4	80		26,00€

ACESSÓRIOS DO VEÍCULO

51863

54,00€

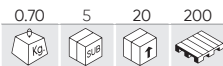

SENSOR DE ESTACIONAMENTO COM MEDIDOR DE APROXIMAÇÃO VISUAL E ACÚSTICO

- Voltagem nominal: DC 12 V.
- Potência: 3,6 W.
- Temperatura de trabalho: -20° a 70°.
- 4 sensores de DISTÂNCIA.
- Distância de detecção: 0,3-2,0 m.
- Ângulo de detecção: H>60°, V>60°.
- Rádio frequência: 315 MHz / 433 MHz.
- Inclui indicador de 2 cores do marcador de DISTÂNCIA.
- Sensores pretos. Não se podem pintar.



51973

45,00€

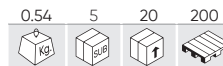

SENSOR DE ESTACIONAMENTO COM MEDIDOR DE DISTÂNCIA ACÚSTICO

- Voltagem nominal: DC 12 V.
- Potência: 3,6 W.
- Temperatura de trabalho: -20° a 70°.
- 4 sensores de DISTÂNCIA.
- Distância de detecção: 0,3-2,0m.
- Ângulo de detecção: H>60°, V>60°.
- Rádio frequência: 315 MHz/433 MHz.
- Sem indicador visual.
- Inclui buzzer de 4cm diâmetro.
- Sensores pretos. Não se podem pintar.



TUBOS FLEXÍVEL INNERBRAID



REF.	DESCRIÇÃO					€
51706	Ø 25mmL x 300mmL	0.35	-	25	1500	22,80€
51707	Ø 45mmL x 100mmL	0.27	-	25	1200	9,05€
51708	Ø 45mmL x 150mmL	0.38	-	25	-	14,20€
51709	Ø 45mmL x 200mmL	0.50	-	25	-	14,70€
51710	Ø 45mmL x 250mmL	0.65	-	25	600	17,80€
51711	Ø 45mmL x 300mmL	0.71	-	25	-	21,20€
51712	Ø 50mmL x 100mmL	0.30	-	25	-	8,65€
51713	Ø 50mmL x 150mmL	0.45	-	25	-	13,10€
51714	Ø 50mmL x 200mmL	0.56	-	25	-	15,80€
51715	Ø 50mmL x 250mmL	0.70	-	25	-	20,30€
51716	Ø 50mmL x 300mmL	0.83	-	25	450	23,60€

REF.	DESCRIÇÃO					€
51717	Ø 55mmL x 100mmL	0.35	-	25	-	11,20€
51718	Ø 55mmL x 150mmL	0.50	-	25	-	14,80€
51719	Ø 55mmL x 200mmL	0.65	-	25	-	22,00€
51720	Ø 55mmL x 250mmL	0.85	-	25	350	23,50€
51721	Ø 55mmL x 300mmL	1.00	-	25	375	25,00€
51722	Ø 60mmL x 100mmL	0.36	-	25	750	13,10€
51723	Ø 60mmL x 150mmL	0.50	-	25	450	18,70€
51724	Ø 60mmL x 200mmL	0.66	-	25	400	24,40€
51725	Ø 60mmL x 250mmL	0.83	-	25	-	28,30€
51726	Ø 60mmL x 300mmL	0.96	-	25	250	31,40€
51727	Ø 60mmL x 400mmL	1.62	-	25	200	49,00€

DISPONÍVEL EM CAIXA INDIVIDUAL

ACESSÓRIOS DE PNEUS

368 CONTRAPESOS

369 REPARAÇÃO DE FUROS

370 VÁLVULAS DE PNEUS

371 REMOÇÃO E INSTALAÇÃO

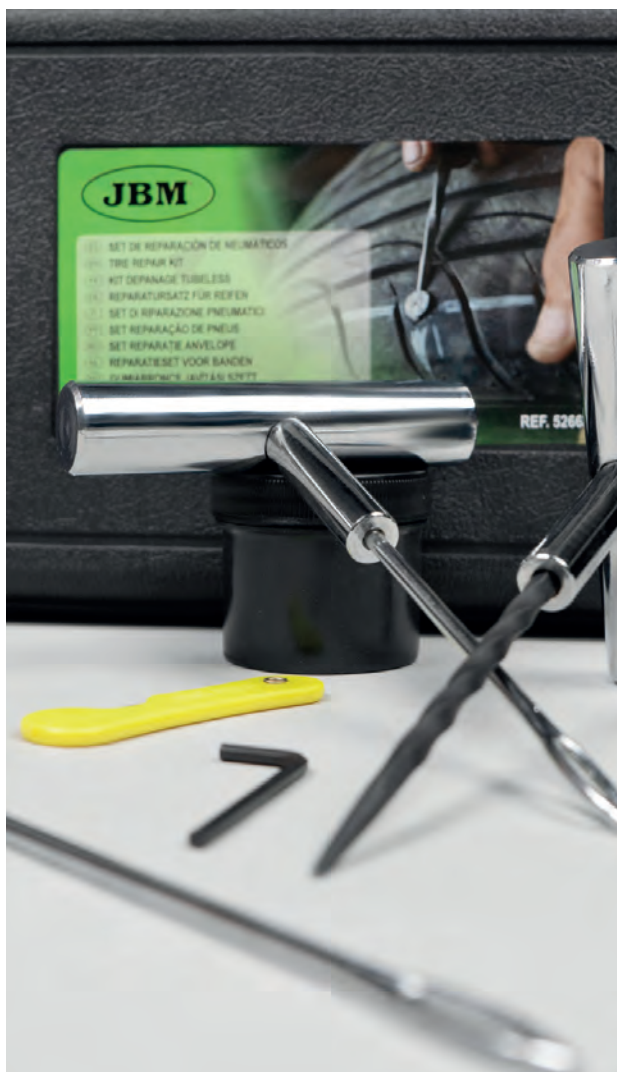

ACESSÓRIOS DE PNEUS

51908

44,00€



DISPENSADOR DE CONTRAPESOS AUTO-ADESIVOS PASTILHAS DE FERRO 5GRX1.000

- 1.000 pastilhas de 5g.
- Auto-adesivos 4mm espessura.
- Medidas do dispensador: 29,5 cm x 29,5 cm.



Com ímã de retenção dos contrapesos restantes.

53256

34,00€



DISPENSADOR DE CONTRAPESOS AUTO-ADESIVOS PASTILHAS DE FERRO 5G X 1.000

- 1.000 pastilhas de 5g.
- Auto-adesivos 4mm espessura.
- Medidas do dispensador: 29,5 cm x 29,5 cm.



CONTRAPESO DE CLIP ADESIVA

REF.	g					€
50600	45g: 3x5g/3x10g	0.05	100	400	36000	0,60€
50601	45g: 3x5g/3x10g	0.05	100	400	48000	0,29€



50600
ZINC

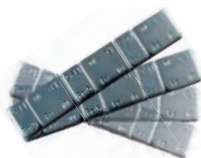

50601
FERRO

CONTRAPESO DE CLIP ADESIVA

REF.	g					€
52665	60g: 12x5g	0.06	100	400	20000	0,37€
52666	60g: 4x10g/4x5g	0.06	100	400	20000	0,36€



52665



52666

CONTRAPESO COM GRAPA DE ZINC

JANTE UNIVERSAL

REF.	g					€
50760	5g	0.01	100	1600	80000	0,10€
50761	10g	0.01	100	1600	102400	0,19€
50762	15g	0.02	100	800	76800	0,29€
50763	20g	0.02	100	800	64000	0,38€
50764	25g	0.03	100	800	48000	0,49€
50765	30g	0.03	100	600	50400	0,58€
50766	35g	0.04	100	400	32000	0,68€
50767	40g	0.04	100	400	25600	0,78€
50768	45g	0.05	100	400	32000	0,88€
51055	50g	0.05	100	400	2000	0,98€



ESPECIAL PARA JANTE ALUMÍNIO

REF.	g					€
50778	5g	0.01	100	1600	80000	0,10€
50779	10g	0.01	100	800	76800	0,19€
50780	15g	0.02	100	1200	60000	0,29€
50781	20g	0.02	100	800	80000	0,38€
50782	25g	0.03	100	600	48000	0,49€
50783	30g	0.03	100	600	30000	0,58€
50784	35g	0.04	100	400	32000	0,68€
50785	40g	0.04	100	400	32000	0,78€
50786	45g	0.05	100	400	32000	0,88€
51604	50g	0.05	100	400	25600	0,98€



CONTRAPESO UNIVERSAL CAMINHÃO

REF.	g					€
52667	50g	0.05	50	400	25600	0,76€
52668	100g	0.10	25	200	12800	1,49€
52669	150g	0.15	20	160	10240	2,22€
52670	200g	0.20	10	80	5120	2,95€
52671	250g	0.25	10	80	5120	3,70€
52672	300g	0.30	10	80	5120	4,45€



52667



52668



52669



52670



52671



52672

53864



138,00€



CAIXA DE CONTRAPESOS SURTIDO

CONTRAPESOS DE ZINC COM GRAPA

PARA JANTE UNIVERSAL

- 5g - 20 uds (ref. 50760)
- 10g - 20 uds (ref. 50761)
- 15g - 20 uds (ref. 50762)
- 20g - 20 uds (ref. 50763)
- 25g - 20 uds (ref. 50764)
- 30g - 10 uds (ref. 50765)
- 35g - 10 uds (ref. 50766)
- 40g - 10 uds (ref. 50767)

PARA JANTE ALUMÍNIO

- 5g - 20 uds (ref. 50778)
- 10g - 20 uds (ref. 50779)
- 15g - 20 uds (ref. 50780)
- 20g - 20 uds (ref. 50781)
- 25g - 20 uds (ref. 50782)
- 30g - 10 uds (ref. 50783)
- 35g - 10 uds (ref. 50784)
- 40g - 10 uds (ref. 50785)

CONTRAPESOS DE CLIP ADESIVAS EM PASTILHAS

60gr: 4x10gr 4x5gr - 70u. (ref. 52666)



51355

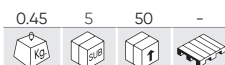

19,00€

ALICATES DE EQUILÍBRIO DE PESO



- Tira fácilmente e substitui o peso.
- Corta e dobra com facilidade.
- Feito de aço reforçado.
- Inclui cabo ergonómico.
- Com mola automática para manter a sua abertura e facilitar a operação.



53150

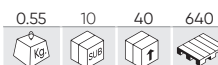

24,00€

COMPRESSOR DE AR



54013



35,00€

KIT DE REPARAÇÃO DE PNEUS - COMPRESSOR DE LÍQUIDO DE AR

REF.	DESCRIÇÃO	Kg	SUB	Q1	Q2	€
A 15317	BOLSA PARA CONJUNTO 54013 (53150)	0.10	-	220	-	4,50€
B 15300	LÍQUIDO SELANTE DE PUNÇÃO - 500ML	0.50	-	12	936	5,00€
C 11960	EXTRACTOR OBUSES	0.01	10	500	-	1,50€
D 53150	COMPRESSOR DE AR	0.55	10	40	640	24,00€

- Veda furos de até 6 mm de diâmetro.
- O material não corrói metais e borracha.
- Fluido de longa duração, não inflamável e resistente ao congelamento.



51814



8,00€

SPRAY TAPA FUROS 300ML

300ml



52653



3,00€

FERRAMENTA PARA OBUSES

- Para posicionar e desposicionar obuses.



52652



2,80€

CHAVE MULTIFUNÇÃO PARA OBUSES



ACESSÓRIOS DE PNEUS

52662

36,50€



KIT DE REPARAÇÃO DE PNEUS



- A 1 x broca
- B 1 x broca para inserir pavios
- C 1 x util para encher pneus
- D 4 x garrafas de ar 16gr
- E 1 x cutter
- F 10 x pavios
- G 1 x chave multifuncionais obuses

52663

30,00€



KIT DE REPARAÇÃO DE PNEUS



- A 1 x broca para inserir pavios
- B 1 x ponta para broca de pavios
- C 1 x broca de perfuração
- D 1 x cutter
- E 20 x pavios
- F 1 x lubrificante

REF.	DESCRIÇÃO						€
12973	PAVIO DE SUBSTITUIÇÃO PARA 52662/52663	0.01	10	500	13500		1,00€
13805	BROCA DE INSERÇÃO DE PAVIOS (REF. 52663)	0.50	10	50	-		10,50€
13806	BROCA DE PERFURAÇÃO (REF. 52663)	0.35	5	50	-		10,50€

52673

18,00€

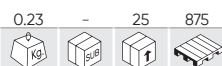

JOGO DE TAMPÃO E OBUSES PARA PNEUS



REPOSIÇÕES DISPONÍVEIS

REF.	DESCRIÇÃO					€
11903	SACO 16U. TAMPÃO ALUMÍNIO P/VÁLVULA PNEUS	0.01	1	100		5,00€
11904	SACO 50U. TAMPÃO PLÁSTICO VERDE P/VÁLVULA PNEUS	0.10	10	500		2,00€
11905	SACO 50U. TAMPÃO PLÁSTICO PRETO P/VÁLVULA PNEUS	0.01	-	10		1,50€
11906	SACO 50U. OBUSES ESTANDAR	0.04	-	100		8,50€
11907	SACO 50U. OBUSES ALTA PRESSÃO	0.05	-	100		11,00€
11960	EXTRACTOR OBUSES	0.01	10	500		1,50€

TAMBÉM DISPONÍVEIS

REF.	DESCRIÇÃO					€
11900	CONJUNTO DE TAMPAS DE ALUMÍNIO PARA VÁLVULA PNEUS	0.01	4	25	250	3,50€
11901	TAMPÃO DE PLÁSTICO VERDE P/VALVULA PNEUS	0.01	4	25	500	2,50€
11902	CONJUNTO DE 4 TAMPÕES DE PLÁSTICO PRETO P/VÁLVULA NEUM.	0.01	4	25	300	3,50€

VÁLVULAS PARA PNEUS

REF.	DESCRIÇÃO						€
51741	TR413 45mm	0.01	100	1000	48000		0,50€
51742	TR414 51mm	0.01	100	1000	48000		0,50€
51743	TR418 64mm	0.02	100	1000	48000		0,55€



FERRAMENTA PARA INSTALAR VÁLVULAS DE PNEUS

REF.	DESCRIÇÃO						€
52649	METAL	0.32	10	50	2250		5,00€
52650	PLÁSTICO	0.15	10	100	2400		5,00€



52657

37,50€



FERRAMENTA DESMONTADORA DE PNEUS



52658

39,70€



FERRAMENTA DESMONTADORA DE PNEUS



52659

39,70€



FERRAMENTA DESMONTADORA DE PNEUS



54329

37,50€



FERRAMENTA DESMONTADORA DE PNEUS



EUR - MADE IN SPAIN

52655

39,70€



AVALANCA PLASTICA DE REMOVER PNEUS



52656

39,50€



AVALANCA PLASTICA DE REMOVER PNEUS



ALAVANCA PARA PNEUMÁTICOS

REF.	"						€
51362	12" (30,48cm)	0.15	5	60	500	3,00€	
51358	16" (40,64cm)	0.47	6	24	1008	7,50€	
51359	24" (60,96cm)	0.90	6	30	1440	9,00€	



CASQUILHO CENTRADOR PARA RODAS DE PESADOS

REF.	mm						€
52645	25x22x2,5mm	0.01	50	1000	38000	0,55€	
52646	25x12x2,0mm	0.00	50	1000	80000	0,50€	
53037	23x12x2,5mm	0.01	50	1000	35000	0,50€	
53038	21x12x2,5mm	0.01	50	1000	35000	0,50€	
53039	25x19x2,5mm	0.02	50	1000	35000	0,50€	
53040	25x9x2,5mm	0.01	50	1000	35000	0,50€	



ACESSÓRIOS DE PNEUS

52664

168,00€



ALAVANCA DE MUDANÇA DE RODAS INDUSTRIAIS



53605

141,00€

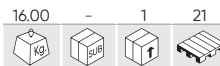

950mm

DESMONTADOR DE PNEU MANUAL

- Aplicabilidade: Todos os pneus de 8 polegadas até pneus para caminhões ligeiros (7-1/2 polegadas x 16 polegadas).
- Passabilidade: Até 12.5L 16.
- Integridade: 1 manivela para quebrar o talão do pneu de 37 polegadas de comprimento. Ferramentas montadora / desmontadora.



52660

126,00€



CARRO PORTA PNEUS, CAP. 200KG



590mm

52552

128,00€



CALÇADORA DE PNEUS PORTÁTIL



REF. DESCRIÇÃO

REF.	DESCRIÇÃO	Kg	Box	Box	Box	Box	€
13741	BOQUILHA DE REPOSIÇÃO PARA 52552	0.35	-	32	-	-	21,00€

53542

980,00€



DESTANOLADOR PNEUMATICO DE PNEUS



54198

59,00€

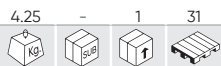

PORTA PNEUS COM RODAS

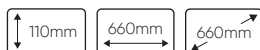

54136

107,00€

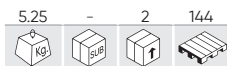

DESMONTADOR DE PNEU MANUAL



52842

11,00€

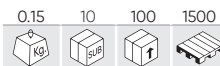

ROLO PARA REPARAÇÃO DA PNEUMÁTICO



53419

9,70€

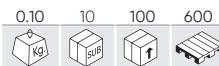

KIT DE 3 PROTETORES DE JANTES



SEGURANÇA E EPI

374 LUVAS/EPI

377 MÁSCARAS / DISPENSADORES

379 DELIMITAÇÃO

380 MEDIDOR DE OZONO

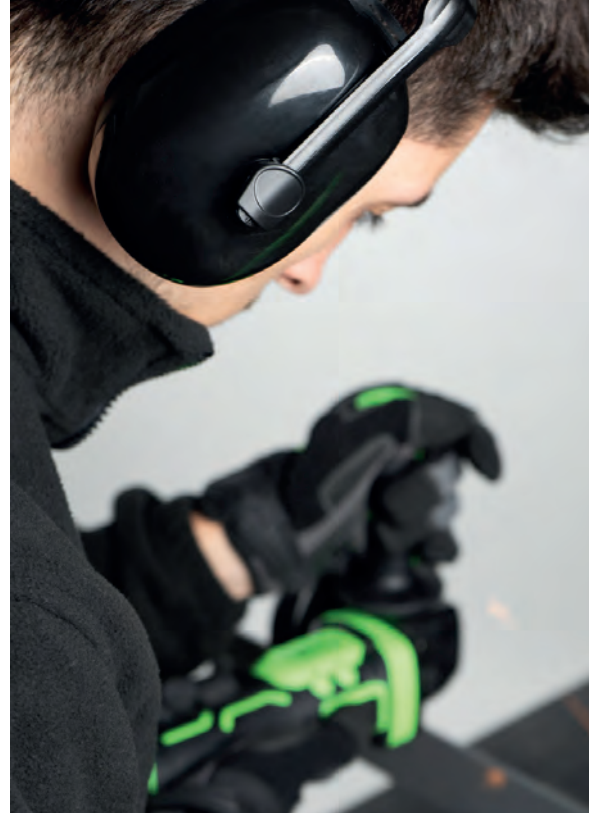



LUVAS DESCARTÁVEIS
100% NITRILO

LUVAS DESCARTÁVEIS DE NITRILO

3.5MIL
4.2g

REF.	UDS.				€
54294	S 100	0.40	10	500	8,00€
53984	M 100	0.45	10	500	8,00€
53985	L 100	0.50	10	500	8,00€
53986	XL 100	0.55	10	500	8,00€



3.5MIL
4.2g

REF.	UDS.				€
54155	M 100	0.46	10	570	8,00€
54156	L 100	0.50	10	570	8,00€
54157	XL 100	0.55	10	570	8,00€



5MIL
5.5g

REF.	UDS.				€
54151	M 100	0.60	10	500	9,00€
54152	L 100	0.60	10	500	9,00€
54153	XL 100	0.60	10	500	9,00€



LUVAS DESCARTÁVEIS DE NITRILO - TEXTURA DIAMANTE

7MIL
8.4g

REF.	UDS.				€
53551	M 100	0.90	10	300	16,00€
53552	L 100	1.00	10	300	16,00€
53553	XL 90	1.00	10	300	16,00€



7MIL
8.4g

REF.	UDS.				€
54177	M 100	0.92	10	300	16,00€
54178	L 100	0.96	10	300	16,00€
54179	XL 90	0.97	10	300	16,00€

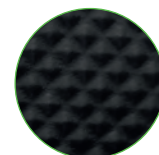

7MIL
8.4g

REF.	UDS.				€
54369	M 100	0.90	10	300	16,00€
54370	L 100	0.88	10	300	16,00€
54371	XL 100	1.05	10	300	16,00€

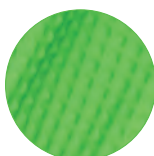

LUVAS COM PALMA REFORÇADA DE POLIURETANO

REF.						€	
51640N	T.8		0.05	12	144	3456	1,54€
51642N	T.9		0.01	12	144	3456	1,54€
51636N	T.10		0.05	12	144	3456	1,54€
51638N	T.11		0.05	12	144	3456	1,54€



LUVAS COM PALMA REFORÇADA DE NITRILO

REF.						€	
51633	T.8		0.04	12	144	3456	1,54€
51634	T.9		0.05	12	144	2592	1,54€
51632N	T.10		0.05	12	144	3456	1,54€
51398N	T.11		0.05	12	144	2592	1,54€



LUVAS TÉRMICAS DE TRABALHO

REF.						€	
54192	T.8		0.15	12	144	3456	8,90€
54193	T.9		0.10	12	144	3456	8,90€
54194	T.10		0.15	12	144	3456	8,90€
54195	T.11		0.10	12	144	3456	8,90€



LUVAS ANTI-CORTE TACTILES

REF.						€	
52570	T.8		0.03	12	144	3456	2,60€
52571	T.9		0.03	12	144	2592	2,60€
52572	T.10		0.03	12	144	2592	2,60€
52573	T.11		0.04	12	144	2592	2,60€



LUVAS DE COURO

REF.						€	
52738	T.9		0.10	12	144	2304	5,00€
52739	T.10		0.12	12	144	2304	5,00€



LUVAS COM PALMA REFORÇADA DE COURO

REF.						€
52310	0.20	12	120	1920		3,65€



SEGURANÇA E EPI

LUVAS DE ALGODÃO

REF.					€
51745	0.05	12	144	4320	0,70€



LUVAS DE ALGODÃO COM PALMA REFORÇADA DE PONTOS DE BORRACHA

REF.					€
51785	0.04	12	300	3600	1,00€



LUVAS DE TRABALHO

REF.					€
54188	T.8 0.15	12	60	2040	19,00€
54189	T.9 0.15	12	60	720	19,00€
54190	T.10 0.15	12	60	720	19,00€
54191	T.11 0.15	12	60	720	19,00€



PARA TELA DE TOQUE



52430

10,90€

0.34	6	24	288

AUSCULTADORES (PASIVO) PARA PROTECÇÃO AUDITIVA



CUMPRE COM: EN352 - 1:2003

53785

4,80€

0.05	14	112	896

ÓCULOS DE PROTEÇÃO - ANTI-NEVOEIRO



CUMPRE COM: EN166:2002-04

ÓCULOS ESPORTIVO DE PROTEÇÃO - ANTI-NEVOEIRO

REF.					€
53596	0.01	12	144	2016	3,65€
53597	0.01	12	144	2016	3,70€
53598	0.01	12	144	2016	3,95€



EM EXPOSITOR DE 12 UDS



CUMPRE COM: EN166:2002-04 / EN166:2003-01



53596



53597



53598

53794

28,00€

0.15	80	1280	

TERMÓMETRO DIGITAL PROFISSIONAL

- Mede a temperatura corporal em 1 segundo e sem contato.
- Desligamento automático após 1 minuto.

TEMPERATURA CORPORAL	32.0°C - 42.2°C (89.6°F - 108°F)
PRECISÃO	±0.2°C (35°C - 42°C)



2 PILHAS A

53862

6,00€

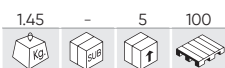

TAPETE COM TANQUE PARA LÍQUIDO DESINFECTANTE

- Medidas: 85x55x10cm
- Material: TPE
- Capacidade máxima recomendada: 3L
- Capacidade máxima: 8L

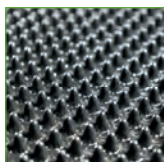

53863

3,00€



TAPETE DE SECAGEM

- Medidas: 76x48cm
- Material: Poliéster

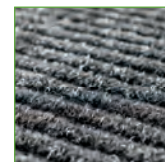

53781

18,00€



DISPENSADOR DE CAPA DE SAPATO AUTOMÁTICO



REF.	DESCRIÇÃO	Kg	Box	Units	€
14781	TAMPA DO SAPATO 100 PCS	0.25	84	336	990€



53797

0,10€

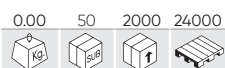

MÁSCARA DE PROTEÇÃO INDIVIDUAL HIGIÊNICA (USO ÚNICO)



Apresentação em caixa com 5 sacos de 10 cada.

USO NÃO MÉDICO

EFICÁCIA DO EFB NA FILTRAÇÃO BACTERIANA	>98%
RESISTÊNCIA À RESPIRAÇÃO	35-50 Pa

Este dispositivo não é um dispositivo médico na aceitação da Diretiva 93/42 ou do Regulamento UE / 2017/745, nem é um equipamento de proteção individual na aceitação do Regulamento UE / 2016/425. PARA USO PESSOAL, NÃO REUTILIZÁVEL.

53957

0,26€

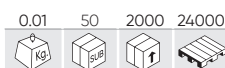

MÁSCARA PRETA DE PROTEÇÃO INDIVIDUAL HIGIÊNICA (USO ÚNICO)



Apresentação em caixa com 5 sacos de 10 cada.

USO NÃO MÉDICO

EFICÁCIA DO EFB NA FILTRAÇÃO BACTERIANA	>90%
RESISTÊNCIA À RESPIRAÇÃO	63-69 Pa

53946

0,83€

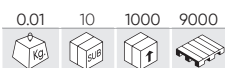

MÁSCARA DE PROTEÇÃO DE AUTO-FILTRO FFP2 - NEGRA



Está em conformidade com a norma EN149:2001+A1:2009
Aprovado de acordo com o regulamento da UE 2016/425

53826

16,00€

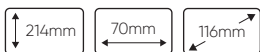
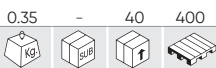

DISTRIBUIDOR AUTOMÁTICO DE GEL - 400 ML

- Compatível com sabonete líquido, álcool, gel e desinfetante para as mãos.
- Sensor de movimento infravermelho inteligente.
- Dosagem: 1ml.
- Tensão: 6V (4 pilas de 1,5V).
- Pilhas não incluídas.



14793

12,00€



BOMBA DOSEADORA PARA GARRAÃO DE 5L



53902

25,00€

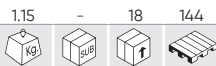

DISPENSADOR AUTOMÁTICO - 1200 ML

- Dosagem: 0,7 ml/1,4 ml
- Distância de ativação do sensor: 80-120 mm
- Tensão: 6 V, 1,5 A (4 baterias de 1,5 V, tipo C - incluídas)
- Dimensões: 160 x 120 x 295 mm
- Material: ABS



53827

32,00€



SUPORTE PARA DISPENSADOR DE GEL AUTOMÁTICO

- Peso: 4.3kg
- Material: Aço
- Cor: preta
- Medidas da bandeja: 417x67mm
- Medidas do suporte do dispensador: 480x133mm
- Diâmetro da base: 395mm



REF. DESCRIÇÃO

REF.	DESCRIÇÃO	Kg	Uds	Uds	€
15059	ADAPTADOR AC/DC 6V 1.5A	0.10	-	200	10,00€
15062	BATERIA R14 C1.5V	0.05	24	480	1,00€

EXTENSIBLE
1.25m - 1.58m

53832

1,81€

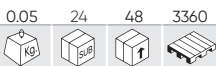

GEL DE MÃOS HIGIENIZANTE 60ML



EM EXPOSITOR DE 24 UDS

53791

4,80€

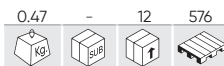

GEL DE MÃOS HIDROALCOÓLICO 500ML



52493

4,50€

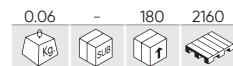

PISTOLA PLÁSTICA PARA LATA DE SPRAY



53940 13,20€



850mm

POSTE DE PLÁSTICO PARA CORRENTE - AMARELO / PRETO

- Material: PVC.
- Base inflável.

CORRENTE NÃO INCLUÍDA.



54322 19,00€



N

CONJUNTO DE 2 SINAIS DE AVISO DE ALTA TENSÃO

165mm 500mm



53987 9,50€

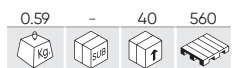

FITA DE SINAL AMARELO/PRETO - 200M

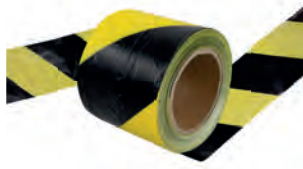

53942 0,50€

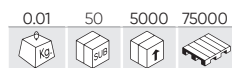

ELO DE FECHAR PRETO



54326 7,30€

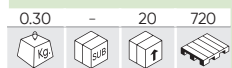

N

CORRENTE DE PVC - 7M - AMARELO/PRETO

7m



53808 16,50€

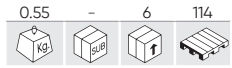

850mm

POSTE DE PLÁSTICO PARA CADEIA

- Material: PVC.
- Base inflável.



53914 75,00€

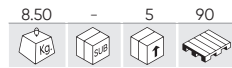

POSTE DE SEPARAÇÃO COM FITA RETRÁCTIL

- Material: aço
- Diâmetro do tubo: 63 mm
- Diâmetro da base: 320 mm
- Altura: 910 mm
- Fita de 4 lados
- Comprimento da correia: 3 m
- Largura da correia: 48 mm



53811 8,90€

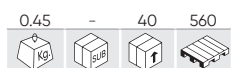

FITA DE SINALIZAÇÃO BRANCA-VERMELHA - 200M



53839 0,25€

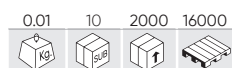

ELO DE FECHAR



53809 8,00€



CORRENTE DE PVC BRANCA/VERMELHA - 5M

- Comprimento: 5m
- Link: 6mm
- Cor: vermelho / branco



53796

76,00€

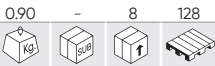

GERADOR DE OZÔNIO PORTÁTIL 600 MG/H (12V/220V)

TEMPORIZADOR
TIMER

15W

15m³/h

O₃
600mg/h

12V

220V

3x10⁶
Ions/cm³



600mg/h

Temporizador/Timer	30/30min	60min	HOLD
--------------------	----------	-------	------

53786

98,00€

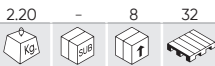

GERADOR DE OZÔNIO PORTÁTIL 5000 MG/H (220V)

67W

80 CFM

2 Amp

5x20mm

TEMPORIZADOR
TIMER

O₃
5000mg/h



5.000mg/h

50m ³	20 min
100m ³	40 min
150m ³	60 min
200m ³	80 min
300m ³	100 min

REF. DESCRIÇÃO



€

14775	PLACA DE REPOSIÇÃO PARA GERADOR PORTÁTIL DE OZÔNIO (REF. 53786)	0.02	-	1	-	30,50€
-------	---	------	---	---	---	--------

53806

250,00€

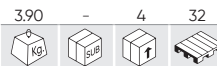

GERADOR DE OZÔNIO PORTÁTIL 20000 MG/H (220V)

TEMPORIZADOR
TIMER

190W

50 dB

O₃
L:1000mg/h
H:20000mg/h

220V

240V

120 CFM

O₃
2000mg/h



10.000mg/h

50m ³	8 min
100m ³	16 min
150m ³	24 min
200m ³	32 min
300m ³	48 min
500m ³	65 min

20.000mg/h

500m ³	30 min
600m ³	40 min
700m ³	50 min
800m ³	60 min
900m ³	70 min
1.000m ³	80 min

REF. DESCRIÇÃO



€

14803	PLACA DE REPOSIÇÃO PARA GERADOR PORTÁTIL DE OZÔNIO	0.03	-	50	-	43,00€
-------	--	------	---	----	---	--------

53838

38,00€



CAIXA DE TRATAMENTO DE OZÔNIO

12V

Amp 0.38
0.42

5V

UV 1550
µW/cm²

2W

O₃
1.5-2.0mg/h

3 MIN



- Comprimento de onda ultravioleta: 254Nm
- Tomada de alimentação: Conector micro USB
- A caixa se monta e desmonta facilmente, facilitando assim seu transporte.

ABERTO



FEXADO



53802

120,00€

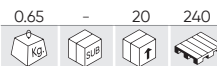

MEDIDOR DE OZÔNIO

- Precisão: ±5% F.S.
- Faixa de medição: 0-50ppm (0-98mg/m³)
- Alarme baixa : 5ppm (9.8mg/m³)
- Alarme alta: 10ppm (19.6 mg/m³)
- Tempo de resposta: <30 segundos
- Faixa de temperaturas operacionais: -10°C - 55°C
- Proteção: IP65



DOIS NÍVEIS DE ALARME CONFIGURÁVEIS PARA DIFERENTES NÍVEIS DE CONCENTRAÇÃO

TEMPO DE OPERAÇÃO: >8H
TEMPO DE CARREGAMENTO: 4H-6H

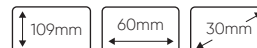

EM CONFORMIDADE COM: EN61326-1, EN61000-4-2, EN61000-4-3

CONSUMÍVEIS

- 383** CHAVETAS E ANÉIS DE RETENÇÃO
- 384** REBITES
- 384** PARAFUSOS, PORCAS, ARRUELAS
- 388** ARRUELAS PARA MOTOR E CARTER
- 391** OUTROS
- 391** JUNTAS E ANÉIS DE VEDAÇÃO
- 392** CONECTORES DE MANGUEIRAS
- 393** ELÉTRICOS
- 396** AGRAFOS E PRESILHAS DE PLÁSTICO



52044

19,00€

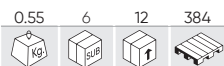

ESTOJO DE CLIPS "R" 150 PEÇAS



REF.	Image	PCS	€
10793		2,3x43	25 0,25€
10794		3,2x52	20 0,40€
10795		3,8x75	8 0,60€
10882		2x32	42 0,25€
10883		1,6x36	30 0,25€
10884		1,6x42	25 0,25€

52027

14,00€

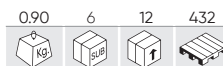

ESTOJO DE CAVILHAS DE FENDAS SORTIDAS 365 PEÇAS



REF.	Image	PCS	€
10796		1,2x25	50 0,07€
10797		1,6x32	50 0,09€
10798		2x40	50 0,12€
10799		2,5x40	50 0,13€
10800		3,2x40	50 0,15€
10801		3,2x50	50 0,17€
10802		4x50	40 0,19€
10803		5x63	10 0,05€
10804		6,3x63	15 0,22€

53348

14,00€

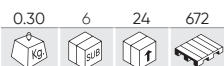

ESTOJO DE CIRCLIPS TIPO "E"



Image	PCS
M1.5 - 1/16"	15
M3 - 1/8"	15
M5 - 3/16"	20
M6 - 1/4"	25
M9 - 3/8"	25
M12 - 1/2"	20
M15 - 5/8"	10
M19 - 3/4"	10
M22 - 7/8"	10

53350

14,00€



ESTOJO DE PASSADORES ELÁSTICOS



1/16" x 3/16"	4	3/16" x 5/8"	5
1/16" x 5/16"	4	3/16" x 1"	5
1/16" x 3/4"	4	3/16" x 1-1/4"	5
5/64" x 1/4"	4	7/32" x 5/8"	4
5/64" x 1/2"	4	7/32" x 1-1/4"	4
5/64" x 1"	4	7/32" x 1-3/4"	4
3/32" x 5/8"	4	1/4" x 5/8"	4
3/32" x 1"	4	1/4" x 1-1/4"	4
3/32" x 1-1/4"	4	1/4" x 1-3/4"	4
1/8" x 5/8"	5	5/16" x 3/4"	4
1/8" x 1"	5	5/16" x 1-1/2"	4
1/8" x 1-1/4"	5	5/16" x 2"	4
5/32" x 5/8"	4	3/8" x 3/4"	2
5/32" x 1"	4	3/8" x 1-1/2"	2
5/32" x 1-1/2"	4	3/8" x 2"	2

53363

34,00€



ESTOJO DE PASSADORES CLEVIS



Image	PCS
3.5x44	6
2.5x42	20
2.5x58	7
2x3	7

Image	PCS
8x50	5
9.5x50	18
11x63	5
12.5x50	3

53364

16,00€



ESTOJO DE CHAVETAS



Image	PCS
3x3x25	4
3x3x20	4
5x5x30	5
5x5x25	5
5x5x20	5
6x6x40	5
6x6x30	5
6x6x20	5
8x8x40	5
8x8x30	5
10x10x40	5
10x10x30	5
12x12x40	2

53371

29,00€

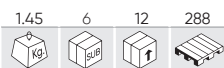

ESTOJO DE PASSADORES COM ANILHA

50 PCS



	PCS
5x36	16
6x45	18
8x45	6
11x45	10

53372

26,00€



ESTOJO DE CHAVETAS

144 PCS



	PCS
M3x50	50
M4x60	30
M5x75	20
M6x50	20
M6x75	16
M8x60	8

53373

14,50€

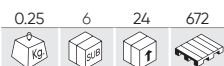

ESTOJO DE ANILHAS DENTADAS INTERIOR

260 PCS



	PCS
M3x10	30
M4x12	30
M5x14	40
M6x14	50
M8x18	50
M10x20	40
M12x25	20

53383

11,50€



ESTOJO DE ANILHAS SEEGER EXTERIORES

300 PCS



	PCS
M4	50
M6	40
M8	45
M10	30
M12	30
M14	25
M16	25
M18	25
M20	15
M22	15

53382

11,00€

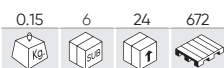

ESTOJO DE ANILHAS SEEGER INTERIORES

300 PCS



	PCS
M4	50
M6	40
M8	45
M10	30
M12	30
M14	25
M16	25
M18	25
M20	15
M22	15

52711

27,50€



ESTOJO DE REBITES PLASTICO

150 PCS



REF.		PCS	€
13674	6x19,3mm	25	0,50€
13675	6x17,8mm	25	0,50€
13676	6x25,5mm	25	0,50€
13677	6x24,5mm	25	0,50€
13678	6x24mm	50	0,50€

52703

22,00€



ESTOJO DE REBITES FÊMEA 235 PCS

235 PCS



REF.		PCS	€
13235	M3	50	0,15€
13236	M4	50	0,15€
13237	M5	50	0,15€
13238	M6	40	0,20€
13239	M8	20	0,20€
13240	M10	15	0,40€
13241	M12	10	0,55€

53360

18,00€



ESTOJO DE REBITES PORCA

150 PCS



	PCS
3x9	40
4x11	35
5x13	25
6x15	25
8x18	15
10x21	10

53361

24,00€



ESTOJO DE REBITES PORCA DE ALUMÍNIO

150 PCS



	PCS
3x9	40
4x11	35
5x13	25
6x15	25
8x18	15
10x21	10

52043

16,50€



ESTOJO DE REBITES 300 PEÇAS

300 PCS



REF.		PCS	€
10877	4,8x16,90mm	50	0,25€
10878	4,8x24,80mm	40	0,30€
10879	3,2x9,70mm	90	0,20€
10880	4,8x12,70mm	70	0,20€
10881	4,8x20mm	50	0,25€

53351

12,50€

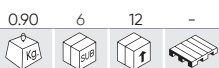

ESTOJO DE PARAFUSOS E PORCAS

240 PCS



	PCS		PCS
M4x12	10	M4	20
M4x20	10	M5	20
M5x16	10	M6	20
M5x25	10	M8	10
M6x20	10	M10	10
M6x30	10		PCS
M8x25	5	M4	20
M8x40	5	M5	20
M10x16	5	M6	20
M10x40	5	M8	10
		M10	10

53354

14,00€



ESTOJO DE PARAFUSOS AUTORROSCANTES

200 PCS



	PCS
#8x12.5	30
#8x16	30
#8x19	30
#8x25	30
#10x12.5	20
#10x16	20
#10x19	20
#10x25	20

53362

14,00€

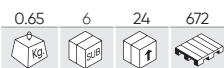

ESTOJO DE PARAFUSOS ALLEN



	PCS
4x12	25
5x12	25
5x25	20
10x40	3
6x25	10
8x40	5
10x25	3
6x12	10
8x25	5



53365

14,00€

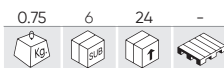

ESTOJO DE PORCAS BOLBOLETA



	PCS
M4	40
M5	40
M6	25
M8	25
M10	20



53366

14,00€

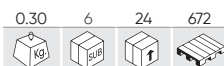

ESTOJO DE PARAFUSOS E PORCAS TIPO U



	PCS
M3.5x8	40
M4.2x16	20
M5x12	15
M6.35x19	10

	PCS
M3.5	20
M3.5 Con muesca/with notch	20
M4	20
M5	15
M6.35	10



53369

14,00€



ESTOJO DE PARAFUSOS



	PCS
2.8x13mm	65
2.8x16mm	55
3.5x10mm	60
3.5x13mm	65
3.5x16mm	60
3.5x19mm	45
4.2x13mm	50
4.2x16mm	40
4.2x25mm	30
4.2x31mm	20
4.8x19mm	25
4.8x25mm	20
4.8x32mm	15



52029

14,00€



ESTOJO DE PORCAS AUTOBLOCANTES 228U.



	PCS
M3	50
M4	50
M5	40
M6	30
M8	20
M10	15
M12	10
M14	8
M16	5



52028

15,20€



ESTOJO DE PORCAS 243 PEÇAS



REF.		PCS	€
10805	M3	50	0,10€
10779	M4	50	0,05€
10780	M5	50	0,05€
10781	M6	30	0,05€
10784	M8	20	0,05€
10785	M10	20	0,10€
10786	M12	10	0,15€
10812	M14	8	0,30€
10813	M16	5	0,30€



CONSUMÍVEIS

52032

28,00€



ESTOJO DE ANILHAS DE PRESSÃO PRETAS - 1.735U.

1735 PCS



	PCS
3mm	600
4mm	400
5mm	220
6mm	220
8mm	110
10mm	65
12mm	50
14mm	40
16mm	30



53377

20,00€

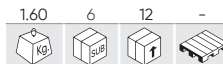

ESTOJO DE ANILHAS DE FERRO SOBRE-MEDIDAS

240 PCS



	PCS
20x6x1.5	20
20x8x1.5	20
20x10x1.5	20
25x6x1.5	20
25x8x1.5	20
25x10x1.5	20
32x2x1.5	20
32x4x1.5	20
32x6x1.5	20
32x8x1.5	20
32x10x1.5	20
32x10x1.5	20



52158

38,50€



ESTOJO DE ANILHAS DE FERRO GALVANIZADO, 475PCS

475 PCS

	PCS		PCS
5x20x1.5	50	6x30x2	25
6x20x1.5	50	7x30x2	25
7x20x1.5	50	8x30x2	25
8x20x1.5	50	4x11x0.98	50
8x25x1.75	50	12x40x3	25
10x30x2.5	25	4x20x1.5	50



51804

58,00€



ESTOJO DE PARAFUSOS, PORCAS E ANILHAS

828 PCS

REF.	DESCRIÇÃO	PCS	€
10772	PARAFUSO ZINCADO DIN 933 8.8 M4X25	25	0,05€
10773	PARAFUSO ZINCADO DIN 933 8.8 M5X50	25	0,10€
10774	PARAFUSO ZINCADO DIN 933 8.8 M6X50	25	0,10€
10775	PARAFUSO ZINCADO DIN 933 8.8 M7X50	15	0,15€
10776	PARAFUSO ZINCADO DIN 933 8.8 M8X50	15	0,20€
10777	PARAFUSO ZINCADO DIN 933 8.8 M10X50	12	0,20€
10778	PARAFUSO ZINCADO DIN 933 8.8 M12X60	20	0,35€
10779	FÊMEA ZINCADA DIN 934 M4	50	0,05€
10780	FÊMEA ZINCADA DIN 934 M5	50	0,05€
10781	FÊMEA ZINCADA DIN 934 M6	50	0,05€
10782	FÊMEA ZINCADA DIN 934 M7	50	0,05€
10783	ANILHA ZINCADA DIN 125 M12	50	0,05€
10784	FÊMEA ZINCADA DIN 934 M8	50	0,05€
10785	FÊMEA ZINCADA DIN 934 M10	50	0,10€
10786	FÊMEA ZINCADA DIN 934 M12	40	0,15€
10787	ANILHA ZINCADA DIN 125 M4	50	0,05€
10788	ANILHA ZINCADA DIN 125 M5	50	0,05€
10789	ANILHA ZINCADA DIN 125 M6	50	0,05€
10790	ANILHA ZINCADA DIN 125 M7	50	0,05€
10791	ANILHA ZINCADA DIN 125 M8	50	0,05€
10792	ANILHA ZINCADA DIN 125 M10	50	0,05€

REF.	DESCRIÇÃO	PCS	€
50959	CAIXA 20+1 COMPARTIMENTOS	1	14,00€



53464

153,00€

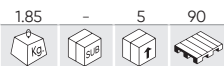

551 PCS

SORTIMENTO DE ANILHAS DE COBRE PARA INJETORES 551 PCS

REPOSIÇÕES DISPONÍVEI

REF.	DESCRIÇÃO	PCS	€
13945	Ø15.0x8.0x1.5 - UNIVERSAL	30	7,40€
13946	Ø15.0x7.0x1.5 - MERCEDES	12	6,70€
13947	Ø13.0x7.5x2.5 - RENAULT	30	5,85€
13948	Ø15.0x7.5x1.5 - IVECO, FORD, BMW, MAN	30	5,00€
13949	Ø15.0x7.5x2.0 - IVECO, FORD, BMW, MAN	30	6,50€
13950	Ø15.45x8.0x2.0 - UNIVERSAL	30	7,80€
13951	Ø13.5x10x2.0 - MAZDA (REF.. 53464)	12	5,15€
13952	Ø15.5x7.5x2.5 - FORD	30	10,90€
13953	Ø15.5x7.5x1.5 - LAND ROVER	12	8,00€
13954	Ø15.0x7.5x3.0 - RENAULT	30	12,70€
13955	Ø13.0x7.0x1.5 - DEUTZ	12	4,95€
13956	Ø13.5x7.5x1.5 - FORD	30	4,30€
13957	Ø15.0x7.5x1.5 - FIAT	12	9,70€
13958	Ø15.5x7.5x1 - MAN ROVER	12	5,45€
13959	Ø16.5x7.5x2 - MERCEDES	30	10,10€
13960	Ø13.7x7.3x3 - KIA	12	9,65€
13961	Ø13.7x7.3x2 - KIA	12	9,25€
13962	Ø10x6.0x1.0	50	1,76€
13963	Ø15.8x7.5x3.0	30	12,40€
13964	SACO DE 30 CONECTORES DE MANGUEIRA EM "T"	20	15,00€
13965	Ø8x5.8x1	30	1,50€
13966	SACO DE 30 CONECTORES DE MANGUEIRA EM "L"	30	12,90€
13967	SACO DE 30 RETENÇÃO SPRINGS	25	4,65€



52031

44,00€



SORTIMENTO DE ANILHAS ALUMÍNIO 900 PEÇAS



Ø	PCS
3x7x1.5	50
4x8x1.5	50
5x6x1.5	50
16x22x1.5	50
14x22x1.5	50
14x20x1.5	50
6x10x1.5	50
6x11x1.5	50
7x11x1.5	50
7x12x1.5	50
8x12x1.5	50
8x14x1.5	50
9x12x1.5	50
10x14x1.5	50
11x16x1.5	50
11x17x1.5	50
12x16x1.5	50
12x18x1.5	50



53353

18,00€



SORTIMENTO DE ANILHAS DE COBRE



Ø	PCS
M6	30
M8	25
M10	20
M12	15
M14	10
M16	10



52163

95,00€

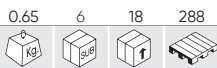

SORTIMENTO DE ANILHAS DE COBRE PARA BUJÕES DE CÁRTER



REPOSIÇÕES DISPONÍVEI

REF.	mm	PCS	€
51538	Ø 10mm	100	0,15€
51539	Ø 12mm	100	0,15€
51540	Ø 14mm	100	0,15€
51541	Ø 16mm	100	0,25€
51542	Ø 18mm	100	0,20€
51543	Ø 20mm	25	0,25€

VOCÊ PODE GOSTAR...

REF.	mm	PCS	€
51544	Ø 22mm	100	0,25€
51545	Ø 26mm	100	0,30€

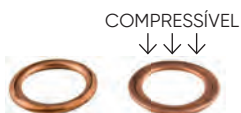

52030

98,00€



SORTIMENTO DE ANILHAS DE COBRE DE 900 PEÇAS



REPOSIÇÕES DISPONÍVEI

REF.	mm	PCS	€
10823	3x7x1,5mm	50	0,20€
10824	4x8x1,5mm	50	0,20€
10825	5x6x1,5mm	50	0,20€
10826	16x22x1,5mm	50	0,40€
10827	14x22x1,5mm	50	0,60€
10828	14x20x1,5mm	50	0,45€
10829	6x10x1,5mm	50	0,20€
10830	6x11x1,5mm	50	0,20€
10831	7x11x1,5mm	50	0,20€

REF.	mm	PCS	€
10832	7x12x1,5mm	50	0,20€
10833	8x12x1,5mm	50	0,20€
10834	8x14x1,5mm	50	0,25€
10835	9x12x1,5mm	50	0,25€
10836	10x14x1,5mm	50	0,30€
10837	11x16x1,5mm	50	0,30€
10838	11x17x1,5mm	50	0,30€
10839	12x16x1,5mm	50	0,40€
10840	12x18x1,5mm	50	0,35€



ESTOJO DE ANILHAS DE COBRE PARA INJETORES

53229

38,70€



PCS	PCS
13,8 x 7,3 x 1,4mm 10	15,0 x 7,5 x 3,0mm 10
14,6 x 7,5 x 1,3mm 10	15,5 x 7,5 x 2,0mm 10
14,6 x 7,5 x 3,0mm 10	16,0 x 7,5 x 1,5mm 10
15,0 x 7,0 x 2,0mm 10	16,0 x 7,5 x 1,7mm 10
15,0 x 7,5 x 1,0mm 10	16,0 x 7,5 x 2,0mm 10
15,0 x 7,5 x 1,5mm 10	16,4 x 7,5 x 2,0mm 10
15,0 x 7,5 x 2,0mm 10	20,0 x 9,4 x 0,9mm 10
15,0 x 7,5 x 2,5mm 10	



53340

86,00€



PCS	PCS
13,8 x 7,3 x 1,4mm 25	15,0 x 7,5 x 3,0mm 25
14,6 x 7,5 x 1,3mm 25	15,5 x 7,5 x 2,0mm 25
14,6 x 7,5 x 3,0mm 25	16,0 x 7,5 x 1,5mm 25
15,0 x 7,0 x 2,0mm 25	16,0 x 7,5 x 1,7mm 25
15,0 x 7,5 x 1,0mm 25	16,0 x 7,5 x 2,0mm 25
15,0 x 7,5 x 1,5mm 25	16,4 x 7,5 x 2,0mm 25
15,0 x 7,5 x 2,0mm 25	20,0 x 9,4 x 0,9mm 25
15,0 x 7,5 x 2,5mm 25	



53229 - 53340 REPOSIÇÕES DISPONÍVEI

REF.	mm	PCS	€
13819	13,8 x 7,3 x 1,4mm	50	6,50€
13820	14,6 x 7,5 x 1,3mm	50	7,00€
13821	14,6 x 7,5 x 3,0mm	50	14,00€
13822	15,0 x 7,0 x 2,0mm	50	11,00€

REF.	mm	PCS	€
13823	15,0 x 7,5 x 1,0mm	50	6,00€
13824	15,0 x 7,5 x 1,5mm	50	8,00€
13825	15,0 x 7,5 x 2,0mm	50	11,50€
13826	15,0 x 7,5 x 2,5mm	50	13,00€

REF.	mm	PCS	€
13827	15,0 x 7,5 x 3,0mm	50	15,00€
13828	15,5 x 7,5 x 2,0mm	50	11,50€
13829	16,0 x 7,5 x 1,5mm	50	10,50€
13830	16,0 x 7,5 x 1,7mm	50	10,50€

REF.	mm	PCS	€
13831	16,0 x 7,5 x 2,0mm	50	12,60€
13832	16,4 x 7,5 x 2,0mm	50	13,00€
13833	20,0 x 9,4 x 0,9mm	50	9,00€

54390

199,00€



N

CONJUNTO DE CONECTORES E TUBOS DE COMBUSTÍVEL (95 PÇS)

REPOSIÇÕES DISPONÍVEI

REF.	mm	PCS	€	REF.	mm	PCS	€
16462	6,3x6mm	3	36,50€	16538	7,5x200mm	3	19,50€
16463	7,89x8mm	3	36,50€	16539	12x200mm	1	18,00€
16464	9,49x8 mm	3	36,50€	16540		1	13,00€
16465	9,89x8 mm	3	39,50€	16541	6x340mm	2	13,00€
16466	11,80x10mm	3	50,00€	16542	8x340mm	6	23,50€
16467	6,3x6 mm	3	36,50€	16543	9,5x340mm	2	13,00€
16468	7,89x8 mm	3	36,50€				
16469	9,49x8 mm	3	36,50€				
16470	9,89x8 mm	3	39,50€				
16471	11,8x10mm	3	50,00€				
16472	6,3x6 mm	5	17,50€				
16473	7,89x8mm	5	17,50€				
16474	9,49x8 mm	5	17,50€				
16475	9,89x8mm	5	17,50€				
16476	11,8x10 mm	5	24,00€				
16477	6x7,5mm	3	24,50€				
16478	8x7,5mm	6	24,50€				
16479	15 - 18mm	12	7,50€				
16480	17-20mm	4	7,50€				

95 PCS



ANILHAS PARA BUJÃO DE CÁRTER FERRO-BORRACHA

REF.	DESCRIÇÃO					€
52719	ANILHAS PARA BUJAO DE CÁRTER FERRO-BORRACHA 10MM DIAM.	0.00	100	5000	150000	0,19€
51843	ANILHAS PARA BUJAO DE CÁRTER FERRO-BORRACHA 12MM DIÂM.	0.01	100	5000	200000	0,19€
51554	ANILHAS PARA BUJAO DE CÁRTER -BORRACHA (FORD) 13MM DIAM.	0.00	100	5000	180000	0,28€
51546	ANILHAS PARA BUJAO CÁRTER FERRO-BORRACHA 14MM DIAM.	0.00	100	5000	150000	0,19€
51799	ANILHAS PARA BUJAO DE CÁRTER FERRO-BORRACHA 16MM DIAM.	0.01	100	120000	120000	0,20€



53599

30,30€

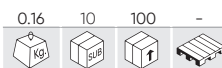

KIT DE VÁLVULAS PARA O AR CONDICIONADO

134 PCS

REPOSIÇÕES DISPONÍVEI

REF.	mm	PCS	€	REF.	mm	PCS	€
14594	5x19mm R12	50	2,00€	14599	7x20mm R134A	10	4,50€
14595	5x19mm	30	1,50€	14600	6x22mm	5	9,50€
14596	5x19mm R12	30	2,00€	14601	8x22mm	1	11,00€
14597	6x19mm	3	7,60€	14602	9x22mm	4	11,00€
14598	6x26mm	1	17,80€				



53358

11,50€

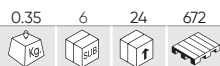

ESTOJO DE MOLAS



	PCS		PCS
	5/16x1-3/4	12	13/64x13/16
			7/32x1
			1/4x7/8
	9/32x1/2	10	5/16x1-1/8
	1/4x13/32	10	5/16x1-1/4
	7/32x11/16	10	3/16x1-3/4
	7/32x1-1/2	10	9/32x1-1/2
	3/8x5/8	6	11/32x1-7/16
	3/8x3/4	12	11/32x1-27/32
	23/64x1-3/8	8	9/32x2
	9/32x3/4	10	5/32x3-1/8



53352

12,00€

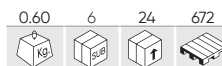

ESTOJO DE PARAFUSOS DE GANCHO



	PCS
	2.4x41
	50
	4x64
	12
	4.2x85
	5

	PCS
	2.4x25
	60
	4x45
	12
	4x50
	12



52033

43,00€

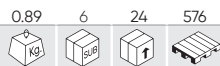

ESTOJO DE BICOS PARA ENGRASSAR - 135 PEÇAS



REF.	90°	PCS	€
10874	6x1	20	0,30€
10875	8x1	15	0,40€
10876	10x1	10	0,45€

REF.	ÂNGULO RECTO	PCS	€
10868	6x1	20	0,30€
10869	8x1	15	0,30€
10870	10x1	10	0,45€

REF.	45°	PCS	€
10871	6x1	20	0,30€
10872	8x1	15	0,40€
10873	10x1	10	0,45€



53359

16,00€

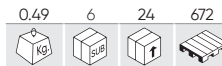

ESTOJO DE LUBRIFICADORES 110 PEÇAS



90°	PCS
6x1	60
8x1.25	10
10x1.5	10

ÂNGULO RECTO	PCS
6x1	5
8x1.25	5
10x1.5	5

45°	PCS
6x1	5
8x1.25	5
10x1.5	5



53378

13,00€

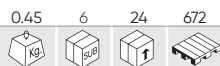

ESTOJO DE ABRAÇADEIRAS DE TUBO 20 PEÇAS



	PCS
	1"
	4
	2-1/2"
	2
	1-1/4"
	2
	3"
	2
	1-3/4"
	2
	3-1/2"
	2
	2"
	4
	4"
	2



53381

14,50€

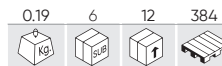

SORTIMENTO DE ANILHAS DE FIBRA 600 PEÇAS



	PCS
	10x5.5x1
	160
	16x10x1
	80
	19x12x1
	40
	22x16x1
	30
	22.5x14x1
	20
	32x22x1
	20
	12x6.5x1
	100
	16x8x1
	60
	20x12.5x1
	40
	27x20x1
	20
	25.4x17.5x1
	15
	32x24x1
	15



50651

18,00€

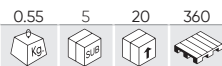

SORTIMENTO DE O'RINGS MÉTRICAS

386 PCS



	TAPA DEL ESTUCHE						BAZA TRUSEI					
POSIÇÃO NO ESTÓJO	006	007	008	009	010	011	211	212	213	214	215	216
LARG. BORRACHA (MM)	2	2	2	2	2	2	3	3	3	3	3	3
Ø INTERIOR (MM)	A 3	4	5	6	7	8	D 20	22	24	25	27	28
QUANTIDADE	16	16	16	16	16	16	12	12	12	12	12	12
POSIÇÃO NO ESTÓJO	113	112	111	110	012	221	220	219	218	217		
LARG. BORRACHA (MM)	B 2.5	2.5	2.5	2.5	2	E 3	3	3	3	3		
Ø INTERIOR (MM)	14	12	11	10	10	36	35	33	32	30		
QUANTIDADE	13	13	13	13	17	12	12	12	12	12		
POSIÇÃO NO ESTÓJO	114	115	116	210	222	325	326	327				
LARG. BORRACHA (MM)	C 2.5	2.5	2.5	3	F 3	4	4	4				
Ø INTERIOR (MM)	16	17	19	19	38	38	41	44				
QUANTIDADE	13	13	13	10	12	10	9	9				



50652

16,50€

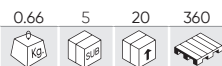

SORTIMENTO DE O'RINGS PULGADAS

382 PCS



	TAPA DEL ESTUCHE						BAZA TRUSEI					
POSIÇÃO NO ESTÓJO	006	007	008	009	010	011	211	212	213	214	215	216
LARG. BORRACHA (MM)	1/16	1/16	1/16	1/16	1/16	1/16	D 1/8	1/8	1/8	1/8	1/8	1/8
Ø INTERIOR (MM)	A 1/8	5/32	3/16	7/32	1/4	5/16	13/16	7/8	15/16	1	11/16	11/18
QUANTIDADE	20	20	20	20	20	20	10	10	10	10	10	10
POSIÇÃO NO ESTÓJO	113	112	111	110	012	221	220	219	218	217		
LARG. BORRACHA (MM)	B 3/32	3/32	3/32	3/32	1/16	E 1/8	1/8	1/8	1/8	1/8		
Ø INTERIOR (MM)	9/16	1/2	7/16	3/8	3/8	17/16	13/8	15/16	11/4	13/16		
QUANTIDADE	13	13	13	13	13	10	10	10	10	10		
POSIÇÃO NO ESTÓJO	114	115	116	210	222	325	326	327				
LARG. BORRACHA (MM)	C 3/32	3/32	3/32	1/8	F 1/8	3/16	3/16	3/16				
Ø INTERIOR (MM)	5/8	11/16	3/4	3/4	11/2	11/2	15/8	13/4				
QUANTIDADE	13	13	13	10	10	7	7	7				
QUANTIDADE												



50807

38,00€

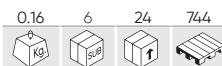

KIT DE O'RINGS PARA AACC

270 PCS



Ø	PCS	Ø	PCS	Ø	PCS
5.29x1.78	20	8.80x1.90	20	13.95x2.62	10
6.07x1.78	20	10.82x1.78	15	14.0x2.0	10
6.8x1.9	20	10.77x2.62	15	15.0x2.0	10
7.65x1.78	20	11.0x2.0	15	17.0x2.0	10
7.80x1.90	20	12.0x2.0	15	17.17x1.78	10
8.0x2.0	20	13.9x1.80	10	17.04x3.53	10



CONSUMÍVEIS

53910

19,00€

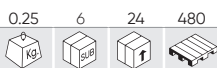

ESTOJO DE CONECTORES DE MANGUEIRA
113 PEÇAS



RETO

4.8x4.8	10		TUBO EM T	3.9x3.9x3.9	8	
6.3x6.3	8		4.8x4.8x4.8	8		
7.9x7.9	6		6.3x6.3x6.3	6		
9.5x9.5	6		9.5x9.5x9.5	3		
3.17x3.17	30		3.17x3.17x3.17	12		

REDUTOR

9.5x6.3	6	
6.3x4.8	10	



53434

18,00€

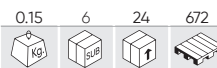

ESTOJO DE CONECTORES DE MANGUEIRA
65 PEÇAS



	PCS	
4x28.7	10	
3.9x30.8	5	
10.4x4.4	10	
5.6x4.71	5	
7.9x3.8	10	
4.7x3.8.9	5	
5.2x3.3.9	10	
7x3.0	10	



53992

18,00€

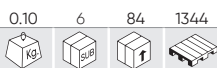

ESTOJO DE MANGAS DE SOLDA
TERMOENCOLHÍVEIS 100PCS



Ø1.7mm / 0.25-0.34mm2 / 26-24 AWG	25
Ø2.7mm / 0.5-1.0mm2 / 22-18 AWG	35
Ø4.7mm / 1.5-2.5mm2 / 16-14 AWG	30
Ø6.0mm / 4.0-6.0mm2 / 12-10 AWG	10



53349

14,00€

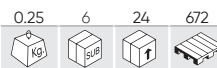

ESTOJO DE PASSA-CABOS DE BORRACHA



ABERTOS	PCS	FECHADOS	PCS
M19,5x23	2	M25	2
M16x24	3	M22	3
M13x15	3	M19	4
M11,5x19	4	M15	5
M10x20	3	M12	10
M10x12	5	M9	20
M9,8x11,5	6	M7	20
M8x14	3		
M7,5x13	7		
M6x7,5	10		
M3,5x6	15		



53374

10,00€

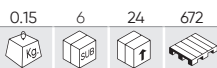

ESTOJO DE TUBOS TERMO-RETRACTÍLES



	PCS
M2x40	30
M2.5x40	25
M3.5x40	20
M5x40	20
M7x80	16
M10x80	8
M13x85	8



53376

10,50€



ESTOJO DE TUBOS TERMO-RETRACTÍLES
VERMELHOS



	PCS
M2x40	30
M2.5x40	25
M3.5x40	20
M5x40	20
M7x80	16
M10x80	8
M13x85	8



REF. DESCRIÇÃO

51920 MAÇARICO

0.14 10 100 400 € 18,00€

53370

26,00€

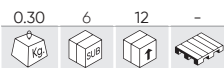

ESTOJO DE PASSA-CABOS DE BORRACHA - M2,3,4,5,6,8,10



	PCS
M2	25
M3	25
M4	30
M5	30
M6	30
M8	20
M10	20

53355

11,50€



ESTOJO DE FUSÍVEIS MINI



	PCS
5A	20
10A	20
15A	20
20A	20
25A	20
30A	20

53356

11,50€



ESTOJO DE FUSÍVEIS



REF.		PCS	€
10915	5A	20	0,25€
10917	10A	20	0,30€

REF.		PCS	€
10918	15A	20	0,30€

REF.		PCS	€
10919	20A	20	0,30€
10920	25A	20	0,25€
10921	30A	20	0,30€

53367

9,50€



ESTOJO DE FUSÍVEIS DE 48 U



	PCS
5A	8
10A	8
15A	8

	PCS
20A	8
25A	8
30A	8

53368

9,00€



ESTOJO DE FUSÍVEIS DE 50 U.



	PCS
5A	8
10A	8
15A	8
20A	8
25A	8
30A	10

53380

11,50€



ESTOJO DE FUSÍVEIS



	PCS
5A	20
10A	20
15A	20
20A	20
25A	20
30A	20

52054

17,00€

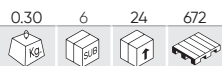

ESTOJO DE FUSÍVEIS 252 PEÇAS



REF.	Icon	PCS	€
10905	3A	20	0,25€
10906	4A	20	0,25€
10907	5A	20	0,25€

REF.	Icon	PCS	€
10908	7,5A	20	0,30€
10909	10A	20	0,30€
10910	15A	20	0,30€

REF.	Icon	PCS	€
10911	20A	20	0,30€
10912	25A	20	0,25€
10913	30A	20	0,30€

REF.	Icon	PCS	€
10914	4A	8	0,25€
10915	5A	8	0,25€
12954	3A	8	0,25€

REF.	Icon	PCS	€
10916	7,5A	8	0,30€
10917	10A	8	0,30€
10918	15A	8	0,30€

REF.	Icon	PCS	€
10919	20A	8	0,30€
10920	25A	8	0,25€
10921	30A	8	0,30€



52053

45,00€

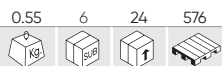

ESTOJO DE TERMINAIS 635 PEÇAS



REF.	Icon	PCS	€
10885	RV1.25-4S	50	0,20€
10886	RV2-4S	50	0,20€
10887	RV2-6S	30	0,25€
10888	RV5.5-6S	20	0,30€
10889	RV5.5-5S	20	0,30€
10893	RV2-5S	40	0,25€

REF.	Icon	PCS	€
10894	SV1-4S	50	0,20€
10895	SV2-4S	40	0,20€

REF.	Icon	PCS	€
10896	FDD1.25-250	45	0,30€
10898	FDD2-250	40	0,30€
10900	FDD5.5-250	25	0,30€

REF.	Icon	PCS	€
10890	BV5.5	15	0,35€
10891	BV2	25	0,25€
10892	BV1.25	30	0,30€

REF.	Icon	PCS	€
10897	MDD1.25-250	50	0,30€
10899	MDD2-250	50	0,30€
10901	MDD5.5-250	30	0,25€

REF.	Icon	PCS	€
10902	FDN 1.25-250	25	0,30€



ALICATE PARA TERMINAIS

PÁGINA 61



53357

7,00€



KIT DE 2 PINÇAS DE CROCODILO



53385

19,30€



ALICATE PARA EXTRAÇÃO DE GRAMPOS DE CARROCERIA



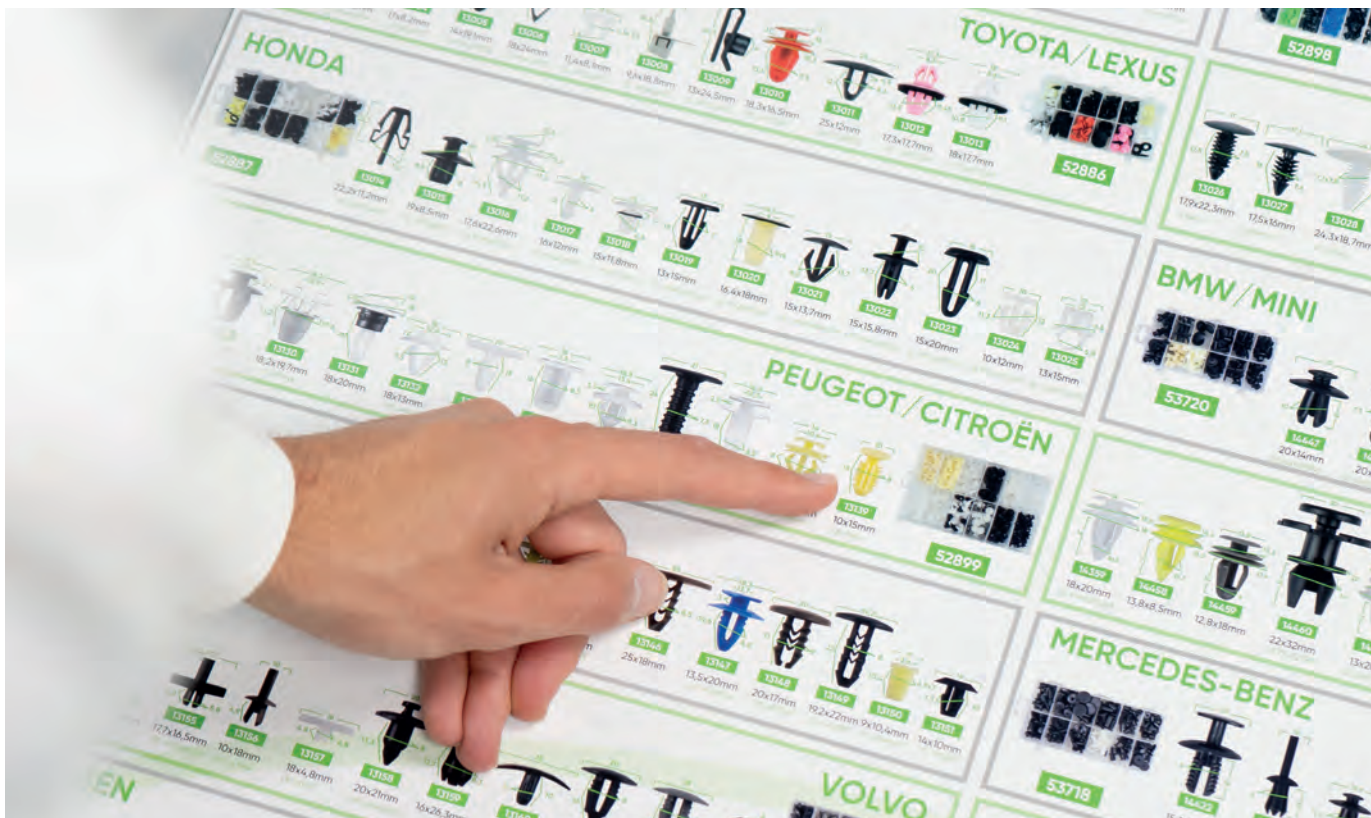

16294 14,00€

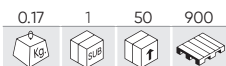

PÔSTER DE CLIPS TAMANHO REAL

ESPECIFICAÇÕES TÉCNICAS:

Tamanho do Poster: 1000x640mm
 Material: Papel de 250g plastificado
 Tem buracos para pendurar.

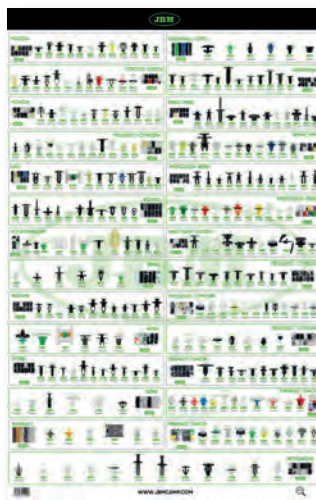

TAMAÑO REAL DE LOS CLIPS
 CLIPS REAL SIZE

52851 9,65€



JOGO DE 2 ALAVANCAS PARA EXTRAÇÃO DE GRAMPOS



53110 27,30€



KIT DE 6 ALAVANCAS



- 5"x8.5mm
- 5"x10.3mm
- 5"x4.5mm
- 15"x8.5mm
- 15"x10.3mm
- 15"x4.5mm



CONSUMÍVEIS



UNIDADES NO CASO

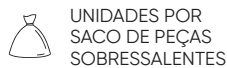

UNIDADES POR SACO DE PEÇAS SOBRESSALENTES



APRESENTAÇÃO EM UM EXPOSITOR

52896

26,00€



SORTIMENTO DE CLIPS PARA MAZDA 190PCS

REF.	DESCRIÇÃO	kg	unidades	€
13104	OE:2042301	8	8	1,90€
13105	OE:999100402	15	15	2,50€
13106	OE:B0016830200	8	8	2,00€
13107	OE:N30413356A	8	8	2,15€
13108	OE:992640543A	20	20	1,90€
13109	OE:99249051B	30	30	2,90€
13110	OE:6508197AA	15	15	1,85€
13111	OE:B1016825200	10	10	1,20€
13112	OE:B09251833	6	6	1,65€
13113	OE:992640543A	20	20	2,20€
13114	OE:B45556741	20	20	2,20€
13115	OE:G03158762	30	30	2,50€

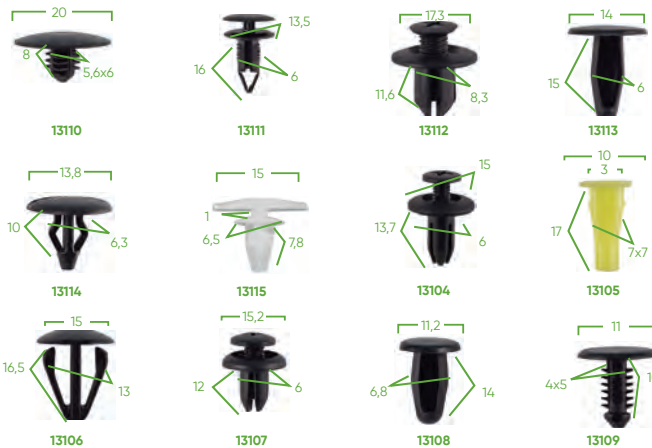

52886

18,00€



SORTIMENTO DE CLIPS PARA LEXUS / TOYOTA 89 PCS

REF.	DESCRIÇÃO	kg	unidades	€
13002	OE:9018906001	8	8	1,45€
13003	OE:9046707138	5	4	1,70€
13004	OE:9046707117	10	10	1,85€
13005	OE:9046709138	10	10	1,25€
13006	OE:9046709101	5	5	1,40€
13007	OE:75521611000	10	10	1,30€
13008	OE:7503933060	8	8	2,25€
13009	OE:9017905060	4	4	1,65€
13010	OE:677711250	8	8	1,75€
13011	OE:9046708124	5	5	1,15€
13012	OE:7539533030	8	8	1,80€
13013	OE:9046711063	8	8	1,75€



52887

22,00€

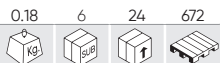

SORTIMENTO DE CLIPS PARA HONDA 150 PCS

REF.	DESCRIÇÃO	kg	unidades	€
13014	OE:75103SJ4003	12	12	1,45€
13015	OE:90675SB003	5	5	1,20€
13016	OE:91566SP0003	6	6	1,15€
13017	OE:91513SE003	25	25	2,60€
13018	OE:91530ST5003	25	25	1,45€
13019	OE:90687SA50030	15	15	1,75€
13020	OE:91620SR2003	8	8	1,70€
13021	OE:38529689A6300	8	8	1,30€
13022	OE:90683SA5003	10	10	2,10€
13023	OE:90672671003	10	10	1,50€
13024	OE:91534SEO000	18	18	2,45€
13025	OE:34355SD2003	8	8	1,50€

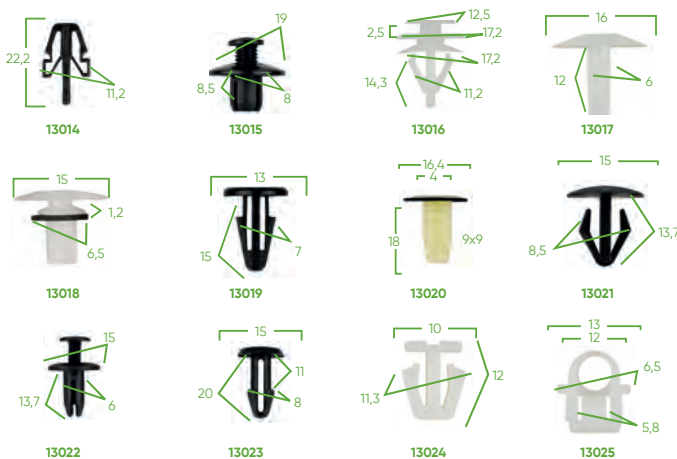

52899

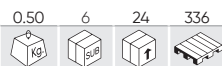

34,00€



SORTIMENTO DE CLIPS PARA PEUGOT / CITROEN 345 PCS

REF.	DESCRIÇÃO	kg	un	un	€
13128	OE:947098	50	50	1,85€	
13129	OE:856535	20	20	2,00€	
13130	OE:6991W4	20	20	3,75€	
13131	-	20	20	3,45€	
13132	OE:694143	25	25	2,65€	
13133	OE:743707	35	35	3,45€	
13134	OE:7703074022	30	30	3,95€	
13135	OE:7703077059	35	35	3,45€	
13136	OE:698317	15	15	2,60€	
13137	OE:699502	25	25	2,25€	
13138	OE:6995X3	30	30	2,85€	
13139	OE:69945	40	40	3,85€	



52900



34,00€



SORTIMENTO DE CLIPS PARA FIAT 308 PCS

REF.	DESCRIÇÃO	kg	un	un	€
13140	OE:14591784	30	30	2,65€	
13141	OE:1459487	20	10	1,80€	
13142	OE:1300433650	25	25	3,10€	
13143	OE:71717421	8	8	1,95€	
13144	OE:82456515	25	25	2,20€	
13145	OE:5757139	25	25	3,85€	
13146	-	20	8	4,50€	
13147	OE:46306526	25	25	3,10€	
13148	OE:14591687	25	25	3,30€	
13149	OE:14592387	25	25	3,10€	
13150	OE:83468473	30	30	2,25€	
13151	OE:7677865	50	30	5,35€	



52901

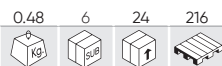

34,00€



SORTIMENTO DE CLIPS PARA VOLVO 350 PCS

REF.	DESCRIÇÃO	kg	un	un	€
13152	OE:8099905N07	25	25	3,05€	
13153	OE:4292906	30	30	3,10€	
13154	OE:12681763	20	20	3,20€	
13155	OE:51131804205	40	40	5,60€	
13156	OE:947098	40	40	3,30€	
13157	OE:591740	40	40	3,85€	
13158	OE:6384801G00	25	25	3,75€	
13159	OE:9133417	20	20	3,20€	
13160	OE:9133073	40	40	5,00€	
13161	OE:3272075327462B	30	30	3,55€	
13162	OE:327462A	20	20	2,60€	
13163	OE:3923712	20	20	2,80€	

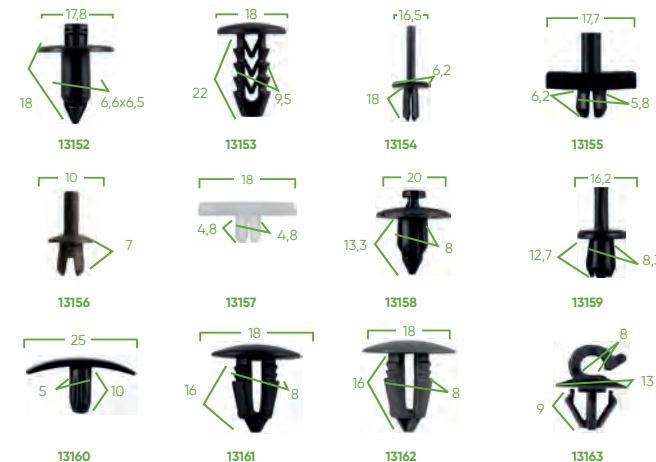

52889

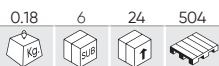

19,00€



SORTIMENTO DE CLIPS PARA VOLKSWAGEN 85 PCS

REF.	DESCRIÇÃO	0.18	6	24	504	€
13038	OE:1H0868243B	2	2			1,40€
13039	OE:N90833801	10	10			1,65€
13040	OE:3A0853575	8	8			1,80€
13041	OE:4A0853825	5	5			1,55€
13042	OE:6U085733	15	15			1,95€
13043	OE:3B0853576	3	3			1,20€
13044	OE:1H0819055B01C	6	6			1,55€
13045	OE:443853909A	5	5			1,20€
13046	OE:171885767	6	6			1,55€
13047	OE:N9020160H	5	5			1,45€
13048	OE:NO385501	10	10			2,20€
13049	OE:191941142	10	10			2,05€

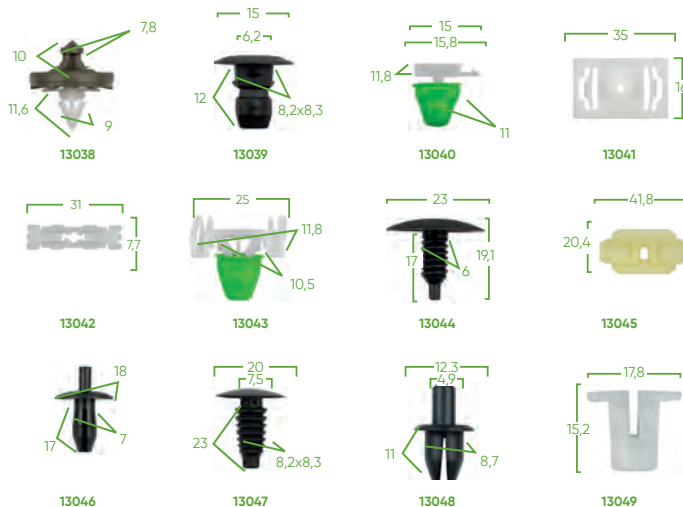

52891



28,00€



SORTIMENTO DE CLIPS PARA FORD 169 PCS

REF.	DESCRIÇÃO	0.16	6	24	672	€
13056	OE:388577S	8	8			1,55€
13057	OE:N801925S	5	5			1,50€
13058	OE:N806289S	20	20			2,20€
13059	OE:N379830S	20	20			2,35€
13060	OE:1007932	5	5			1,60€
13061	OE:16500308	20	20			2,65€
13062	OE:N803170S	20	20			2,35€
13063	OE:W706713S300	6	6			1,15€
13064	OE:N388246S	20	20			2,60€
13065	OE:F22Z16774A	15	15			2,00€
13066	OE:1673046	5	5			2,25€
13067	OE:F1CZ16674A	25	25			2,55€

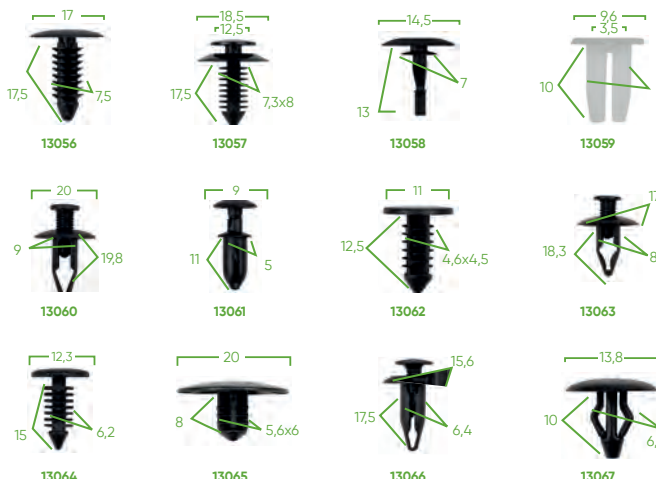

52894

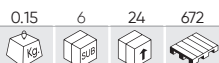

22,00€



SORTIMENTO DE CLIPS PARA NISSAN 139 PCS

REF.	DESCRIÇÃO	0.15	6	24	672	€
13080	OE:76906T300	15	15			1,75€
13081	OE:0155300172	20	20			2,30€
13082	OE:68425H5000	10	10			1,35€
13083	OE:75521611000	6	6			1,50€
13084	OE:62869N4700	20	20			2,10€
13085	OE:6384401A00	5	5			1,60€
13086	OE:7688257A00	5	5			1,25€
13087	OE:6684101G00	25	25			3,30€
13088	OE:1099830880	10	10			2,40€
13089	OE:8942798070	10	10			1,70€
13090	OE:6384801G00	8	8			1,70€
13091	OE:6385401A00	5	5			1,25€



52890

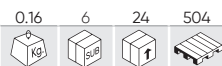

22,00€



SORTIMENTO DE CLIPS PARA AUDI 31 PCS

REF.	DESCRIÇÃO			€
13050	OE:3B0868243	5	15	1,55€
13051	OE:1H0867199A	5	20	1,50€
13052	OE:1H0868243B	3	3	1,25€
13053	OE:357853575	10	10	2,80€
13054	OE:1H0853585A	5	5	2,35€
13055	OE:3A0853575	3	3	3,00€

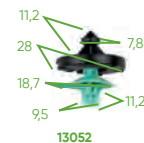

13052



13054

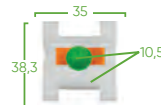

13055

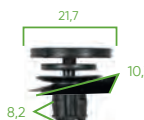

13050



13051



13053



52892

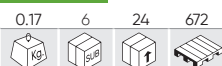

22,00€



SORTIMENTO DE CLIPS PARA BMW 95 PCS

REF.	DESCRIÇÃO			€
13068	OE:51311802258	25	25	2,85€
13069	OE:5131804205	30	30	4,55€
13070	OE:51118174185	10	10	2,15€
13071	OE:51481938725	10	10	2,05€
13072	OE:703867299	15	15	2,75€
13073	OE:51131960054	5	5	2,10€



13068



13069



13070



13071



13072



13073



52897

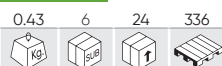

38,00€



SORTIMENTO DE CLIPS PARA RENAULT 300 PCS

REF.	DESCRIÇÃO			€
13116	OE:7703077421	50	50	5,45€
13117	-	50	50	3,65€
13118	OE:7703081184	60	60	15,90€
13119	-	15	15	5,60€
13120	OE:7703074022	60	60	5,50€
13121	OE:7703077059	65	65	8,75€



13116

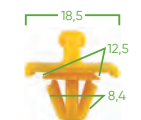

13117



13118

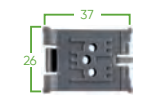

13119



13120

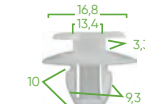

13121



52898



36,00€



SORTIMENTO DE CLIPS PARA VAUXHALL / OPEL 300 PCS

REF.	DESCRIÇÃO			€
13122	OE:90218614	20	20	1,95€
13123	OE:174864	40	40	5,35€
13124	OE:NO385501	100	100	8,20€
13125	OE:2345959	50	50	5,95€
13126	OE:2240582	50	50	1,55€
13127	OE:180942	40	40	5,60€



13122

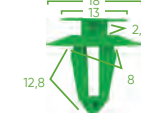

13123



13124

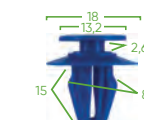

13125

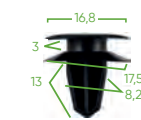

13126



13127



52893

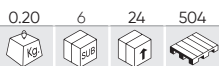

26,00€



SORTIMENTO DE CLIPS PARA BENZ 95 PCS

REF.	DESCRIÇÃO	Caixa	Paquete	€
13074	OE:A0019884481	30	30	4,65€
13075	OE:A0019882981	20	20	5,35€
13076	OE:A1249900492	15	15	3,90€
13077	OE:A0019888081	4	4	2,55€
13078	OE:A1249880492	6	6	2,55€
13079	OE:A0019880325	20	20	3,35€

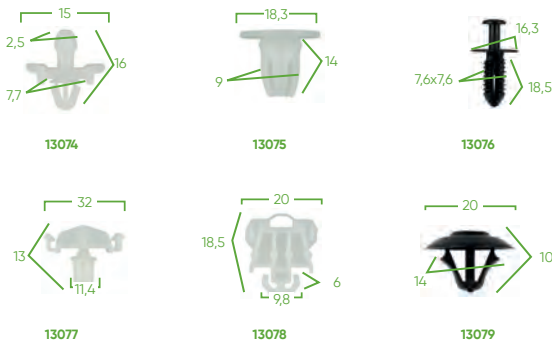

52895



22,00€



SORTIMENTO DE CLIPS PARA MITSUBISHI 134 PCS

REF.	DESCRIÇÃO	Caixa	Paquete	€
13092	OE:8942180270	15	50	1,65€
13093	OE:9018905013	30	30	2,95€
13094	OE:MU480033	10	10	1,50€
13095	OE:128100231	8	6	1,20€
13096	OE:MU480034	8	8	1,70€
13097	OE:MR138807	3	3	1,20€
13098	OE:MB253964	4	4	1,65€
13099	OE:HB121467	30	30	2,75€
13100	OE:MB271999	3	3	1,20€
13101	OE:MB696120	8	8	1,50€
13102	OE:MR200300	5	5	1,60€
13103	OE:MB846992	10	10	1,80€

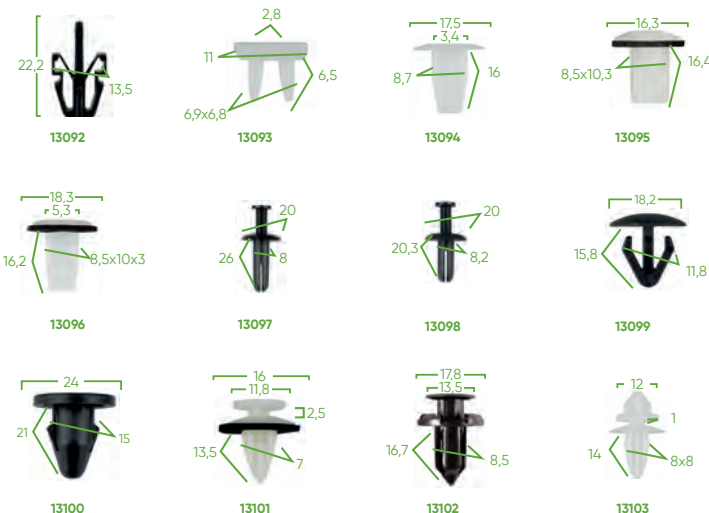

52888



24,00€



SORTIMENTO DE CLIP UNIVERSAL 128 PCS

REF.	DESCRIÇÃO	Caixa	Paquete	€
13026	OE:388577S	8	8	1,55€
13027	-	10	10	1,85€
13028	OE:6003423	6	6	1,45€
13029	OE:VW:N989022 CHRYSLER: 6003349 FORD:385661	6	6	1,65€
13030	OE:CHRYSLER: 6502328 GM:20699808	25	25	2,80€
13031	OE:N804379S	4	4	1,85€
13032	OE:FORD:F22Z16774A MAZDA:6508197AA	15	15	2,00€
13033	OE:GM:16674629 FORD:N806113S	10	10	1,60€
13034	OE:0153301781	20	20	2,65€
13035	OE:GM:10124502 BMW:52201964201 LAND ROVER:- DZM10080	6	6	1,65€
13036	OE:VW:N9020160H BMW:51471904317 OPEL:2207713	6	6	1,40€
13037	-	12	12	2,10€

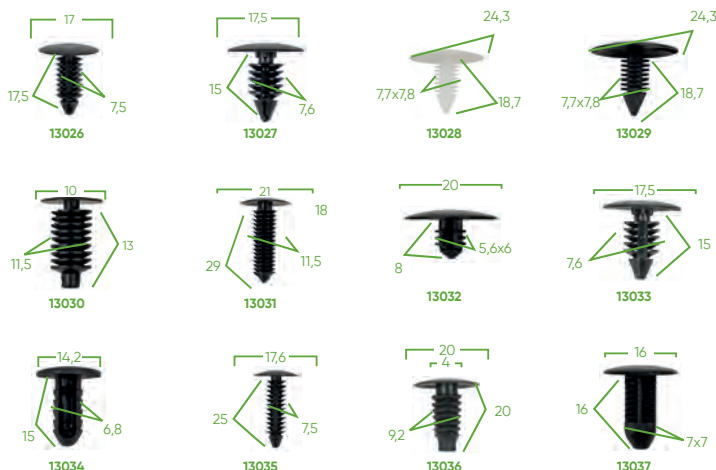

53720

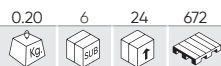

19,00€



SORTIMENTO DE 112 PÇS DE CLIPES PARA TAPEÇARIA DE BMW MINI

REF.	DESCRIÇÃO	QTD	QTD	€
14447	OE: 51471911992	7	6	1,45€
14449	OE: 51717002953	13	10	2,20€
14471	OE: 51489119216	5	5	1,90€
14472	OE: A0009905492	5	5	1,35€
14474	OE: 51118174185	8	8	1,50€
14475	OE: 2019900050	6	6	1,65€
14476	OE: 51481915964	9	9	2,05€
14477	OE: 0009881625	15	15	2,45€
14478	OE: 7146976114	15	15	4,05€
14479	OE: 91503SP0003	6	6	1,65€
14480	-	15	15	2,05€
14481	OE: 51161943122	8	8	1,70€



53719



19,00€



SORTIMENTO DE CLIPES PARA PAINÓS DE PORTA / MOLDURAS

REF.	DESCRIÇÃO	QTD	QTD	€
14359	-	8	8	1,05€
14458	-	6	6	1,70€
14459	OE: 7147122912	2	2	1,45€
14460	OE: 51411973500	8	8	1,15€
14461	-	8	8	1,35€
14462	-	8	8	1,65€
14463	OE: 611769	10	10	1,65€
14464	OE: 7147145753	10	10	1,50€
14465	-	8	8	2,00€
14466	OE: 51418224768	8	4	1,65€
14468	-	8	8	1,30€
14469	OE: 7147133419	8	8	1,45€

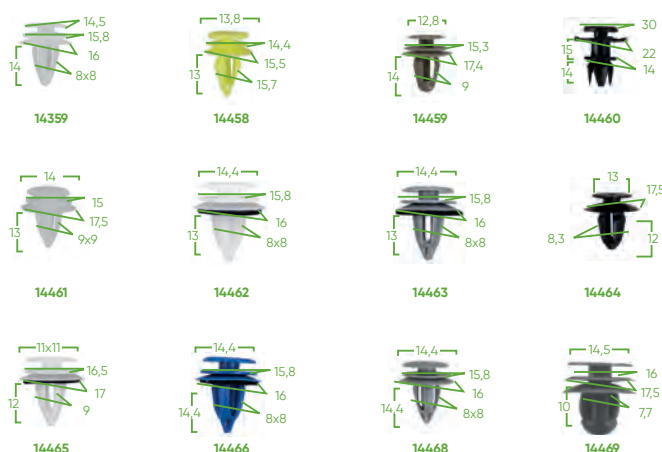

53718

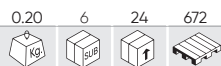

19,00€



SORTIMENTO DE 151 PÇS DE CLIPES PARA TAPEÇARIA DE MERCEDES-BENZ

REF.	DESCRIÇÃO	QTD	QTD	€
14422	OE: A0009913940	20	20	1,50€
14446	OE: 9903492	6	6	2,80€
14447	OE: 51471911992	12	12	1,45€
14448	OE: N105835019B9	10	10	2,05€
14449	OE: A0009905492	12	12	2,20€
14450	OE: N0385012	12	12	2,15€
14451	OE: A1239900092	25	25	2,15€
14452	-	20	20	2,55€
14453	-	6	6	3,05€
14455	-	12	12	2,10€
14456	-	6	6	1,35€
14457	OE: A1249900492	10	10	1,70€

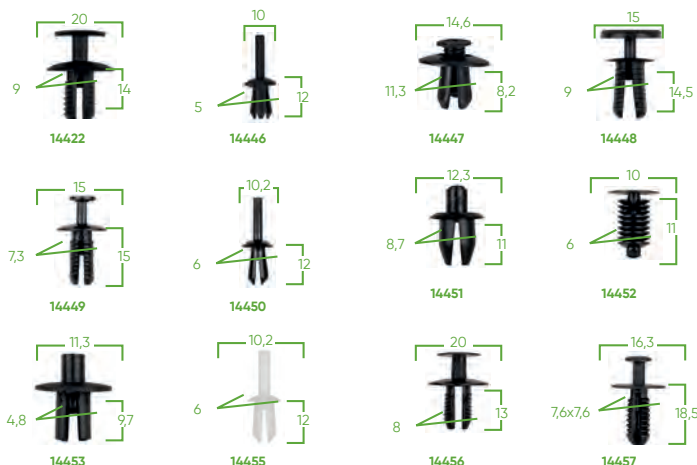

53717

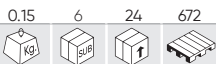

19,00€



SORTIMENTO DE 96 PÇS DE CLIPES PARA PAINÉIS DE PORTA/MOLDURAS DE MERCEDES-BENZ

REF.	DESCRIÇÃO	0.15	6	24	672	€
14434	-	8	8	1,60€		
14435	-	6	6	1,45€		
14436	OE: A0009910198	8	8	1,70€		
14437	OE: A0019912698	6	6	1,45€		
14438	OE: A0089880978	8	8	1,35€		
14439	OE: 0069884378	8	8	1,75€		
14440	-	8	8	1,75€		
14441	OE: 0019884981	10	10	1,65€		
14442	-	6	6	1,45€		
14443	-	8	8	1,45€		
14444	OE: 0019886081	10	10	1,90€		
14445	-	10	10	1,45€		

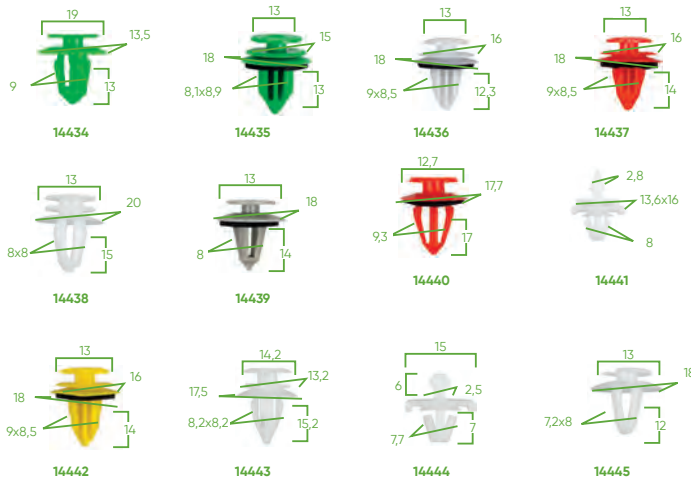

53716

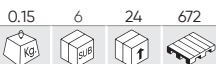

19,00€



SORTIMENTO DE 79 PÇS DE CLIPES PARA PAINÉIS DE PORTA/MOLDURAS/TAPEÇARIA DE VAG/SEAT/SKODA

REF.	DESCRIÇÃO	0.15	6	24	672	€
14422	OE: A0009913940	6	6	1,50€		
14423	OE: 6E0837732	15	15	3,55€		
14424	-	7	7	1,85€		
14425	OE: 6Q0868243	2	2	2,05€		
14426	OE: 171201969	8	8	1,90€		
14427	OE: 4D0807300	8	4	1,20€		
14428	OE: 251823717	12	12	1,40€		
14429	-	6	6	1,80€		
14430	OE: 8E0821989A	3	3	2,25€		
14431	OE: 3B0868243	2	2	1,45€		
14432	OE: 1H0823171	10	10	1,45€		

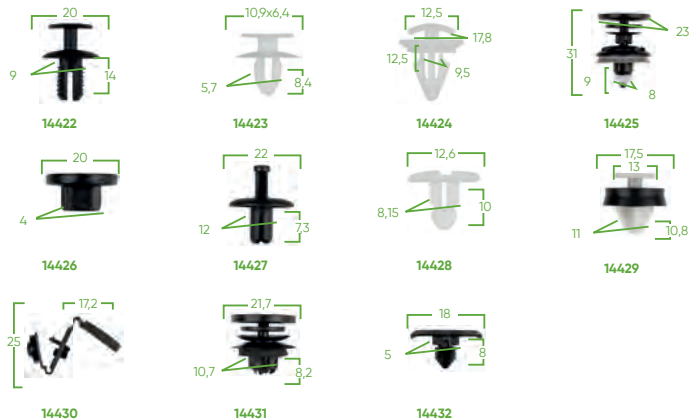

53715

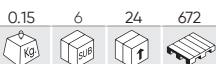

19,00€



SORTIMENTO DE 110 PÇS DE CLIPES PARA TAPEÇARIA DE PEUGEOT/CITROËN

REF.	DESCRIÇÃO	0.15	6	24	672	€
14410	-	10	10	1,85€		
14411	-	10	5	1,70€		
14412	-	10	10	1,70€		
14413	-	10	10	3,25€		
14414	OE: 2346824	10	10	1,70€		
14415	OE: A1249900492	10	10	1,70€		
14416	OE: 6992C6	10	5	1,25€		
14419	-	15	15	1,95€		
14420	-	15	15	1,50€		
14421	OE: 14093311	10	10	2,45€		



53714

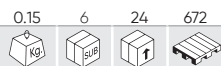

16,00€



SORTIMENTO DE 80 PÇS DE CLIPES PARA MOLDURAS DE PEUGEOT/CITROËN

REF.	DESCRIÇÃO	kg	un	€
14398	OE: 6995X3	8	8	1,30€
14399	OE: 129943	12	6	1,90€
14402	OE: 856548	8	8	1,50€
14404	OE: 71728806	8	8	2,10€
14405	OE: 968865987703	16	8	1,45€
14406	OE: 856540	10	10	1,55€
14408	OE: 856534	10	10	1,45€
14409	OE: 357853586	8	8	1,35€

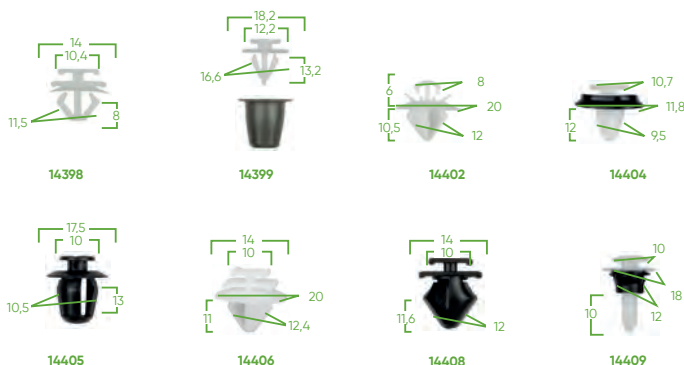

53713

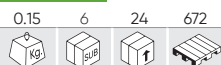

16,00€



SORTIMENTO DE 93 PÇS DE CLIPES PARA PAINÉIS DE PORTA DE PEUGEOT/H16CITROËN

REF.	DESCRIÇÃO	kg	un	€
14350	OE: 6991Y8	6	6	1,80€
14358	OE: PG 6991Y8 CT 6991Y8 FIAT 9654280780 RENAULT 703077469	10	10	1,70€
14387	-	8	8	1,45€
14388	OE: 7703077250	8	8	2,05€
14389	OE: 6995A3	6	6	1,25€
14390	-	6	6	1,35€
14391	-	15	15	2,15€
14392	-	6	6	1,35€
14393	-	8	8	1,50€
14395	-	8	8	1,65€
14396	-	6	6	1,20€
14397	-	6	6	1,45€

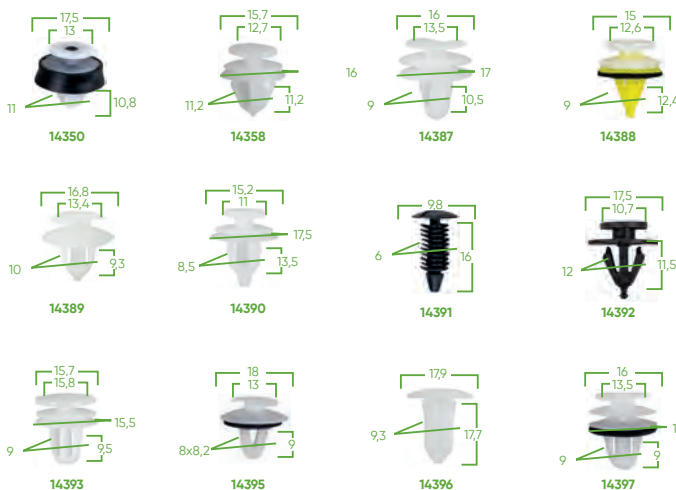

53712

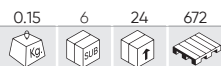

16,00€



SORTIMENTO DE 109 PÇS DE CLIPES DE ESTOFADO PARA TAPEÇARIA DE RENAULT DACIA

REF.	DESCRIÇÃO	kg	un	€
14374	OE: 7703077435	3	3	1,70€
14375	-	15	15	1,85€
14376	OE: 7L6868307	20	20	2,60€
14377	-	10	10	1,90€
14378	OE: 7703077117	12	12	1,90€
14379	-	6	6	1,45€
14381	-	10	10	1,70€
14382	OE: 7703077153	6	6	1,85€
14383	OE: 7703072360	10	10	1,35€
14384	OE: W705956S300	12	12	2,10€
14416	OE: 6992C6	5	5	1,25€



53711

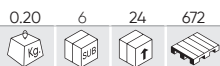

16,00€



SORTIMENTO DE 90 PÇS DE CLIPES PARA MOLDURAS+H13 DE RENAULT DACIA

REF.	DESCRIÇÃO	Qtd	Qtd	€
14356	OE: RENAULT 7703077368 OPEL 4430858	10	10	1,90€
14358	OE: PG 6991Y8 CT 6991Y8 FIAT 9654280780 RENAULT 703077469	12	10	1,70€
14364	OE: OP 7701470779 NI 7703077421 RENUALT 7703077421 IV 500326896	10	10	1,90€
14365	OE: OP 7701470779 NI 7703077421 RENUALT 7703077421 IV 500326896	10	10	1,90€
14366	OE: PG 6991Y8 CT 6991Y8 FIAT 9654280780 RENAULT 703077469	8	8	1,45€
14367	-	3	3	1,30€
14368	OE: 7L5853994	8	8	1,45€
14369	OE: 7701061797	15	15	4,95€
14370	-	3	3	3,00€
14371	-	3	3	3,00€
14372	-	4	4	1,20€
14373	-	4	4	1,35€

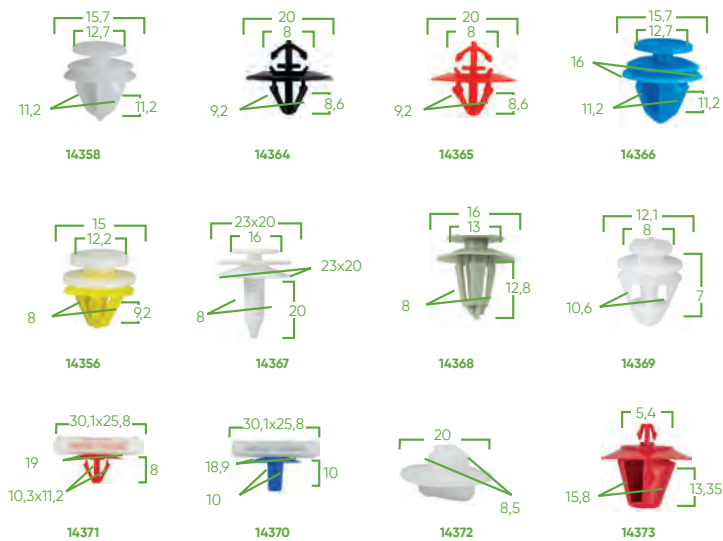

53710



16,00€



SORTIMENTO DE 85 PÇS DE CLIPES PARA PAINÉIS DE PORTA DE RENAULT DACIA

REF.	DESCRIÇÃO	Qtd	Qtd	€
14350	OE: 6991Y8	12	6	1,80€
14351	-	8	15	1,65€
14352	OE: 51447780135	7	7	1,30€
14353	OE: 7703077476	8	2	2,10€
14355	OE: 7703077354	8	8	1,70€
14356	OE: RENAULT 703077368 OPEL 4430858	10	4	1,90€
14357	OE: 7703077430	10	12	1,90€
14358	OE: PG 6991Y8 CT 6991Y8 FIAT 9654280780 RENAULT 703077469	10	6	1,70€
14359	OE: 51418224768	4	3	1,05€
14361	-	8	15	1,70€

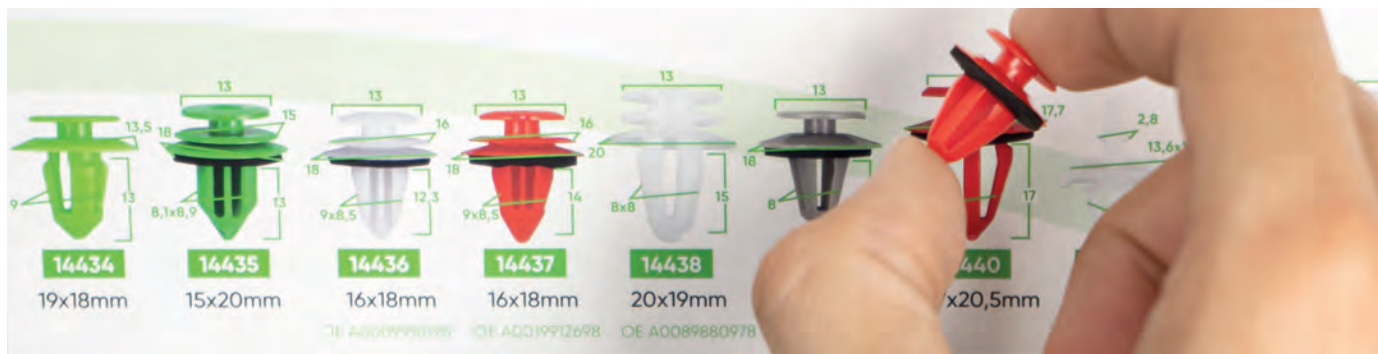
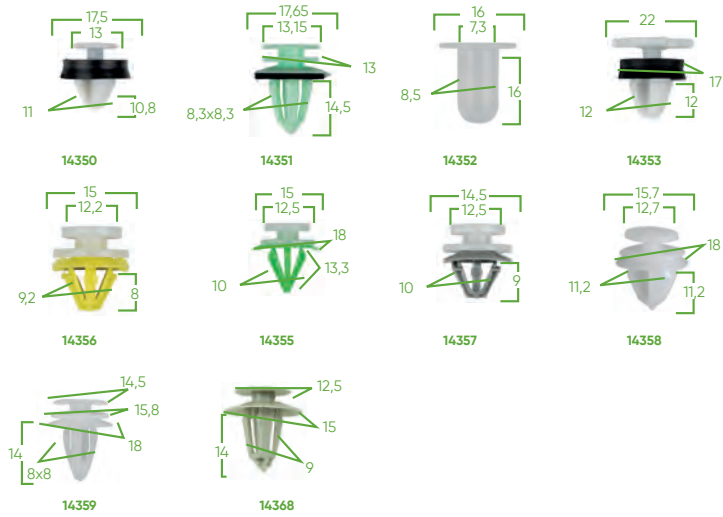

ROUPAS DE TRABALHO

406 COLETES

406 CASACOS

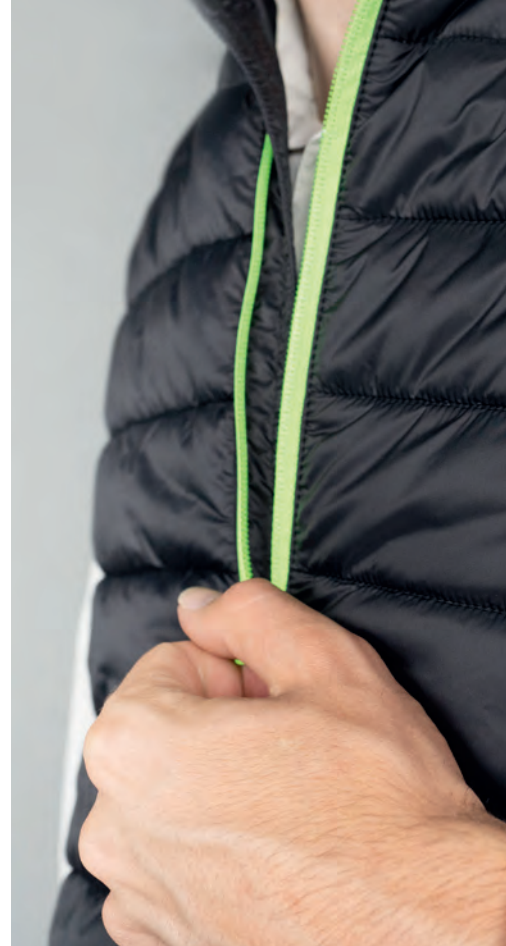



COLETE JBM



REF.		■	■	■	📦	📦	📦	🚚	€
70001	M	●			0.30	-	5	200	35,00€
70002	L	●			0.40	-	5	200	35,00€
70003	XL	●			0.40	-	5	200	35,00€
70009	XL		●		0.40	-	5	180	35,00€
70013	S		●		0.30	-	10	240	44,00€
70014	M		●		0.30	-	10	240	44,00€
70015	L		●		0.30	-	10	240	44,00€
70016	XL		●		0.35	-	10	240	44,00€
70017	XXL		●		0.35	-	10	200	44,00€

JAQUETA JBM



REF.		■	■	■	📦	📦	📦	🚚	€
70004	M	●			0.60	-	5	140	42,00€
70005	L	●			0.70	-	5	140	42,00€
70006	XL	●			0.70	-	5	140	42,00€
70011	L		●		0.60	-	5	120	42,00€
70012	XL		●		0.70	-	5	120	42,00€

13929 3,45€



GANCHO DE VESTUÁRIO 49 CM



METEXP 62,00€



EXPOSITOR



PROMOCIONAL

408 PRODUTOS PROMOCIONAIS

410 ECRÃS / ACESSÓRIOS

412 EMBALAGEMS



PROMOTIONALS

53956

353,00€

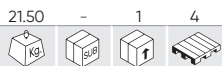

CADEIRA GIRATÓRIA

DIMENSÕES: 70x55x126-136cm

ALTURA AJUSTÁVEL

ALMOFADA LOMBAR

ALMOFADA DE ENCOSTO DE CABEÇA



Material: PU
 Espessura da estrutura de aço: 1,2cm
 Assento: espuma moldada
 Encosto: espuma de poliuretano
 Apoio de braço: 2D
 Elevador a gás: Classe 3
 Base de nylon: 350mm



54043

48,00€

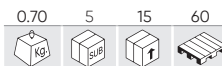

MOCHILA JBM

Espaço de arrumação e bolsos: Com um total de dois compartimentos tem capacidade para NoteBook com menos de 17,3 polegadas e tablets, entre outros.

Material: Poliuretano, é uma mochila impermeável, sólida e resistente.

Leve e confortável: design confortável e respirável em malha de esponja nas costas e nas alças.



53973

284,00€



TENDA FOLDABLE JBM 3X3M

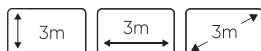

REF.	DESCRIÇÃO	KG	BOX	UN	PAL	€
14347	COBERTURA PROTETORA DO SUPORTE JBM	0.60	-	5	-	36,50€

15152

160,00€

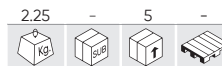

LATERAL P/CARPA STAND JBM 3X3M REF. 53973

Consiste em duas partes:
 - Parte lateral que cobre 3/4 partes da barraca.
 - Parte frontal que cobre 1/4 parte da barraca. Com zíper vertical como porta



54325 22,50€

2.30 - 10 120

Kg SUB f

TAPETE 100X65CM

N



54278 4,50€

0.10 5 200 1800

Kg SUB f

TAMPA JBM

N



54480 1,00€

0.00 500 2000 40000

Kg SUB f

CHAVE DE IGNIÇÃO JBM

N



53949 4,50€

0.10 - 15 540

Kg SUB f

BOLSA REFRIGERADA JBM PRETA

350mm 675mm 675mm



53950 4,50€

0.10 - 15 630

Kg SUB f

BOLSA REFRIGERADA JBM VERDE

350mm 675mm 675mm



13968 1,35€

0.01 50 200 2400

Kg SUB f

SACO JBM PUBLICIDADE



53533 1,50€

0.01 50 1000 12000

Kg SUB f

PEN 4 CORES PROMOCIONAL JBM



54076 9,00€

0.50 - 50 700

Kg SUB f

CANECA JBM

95mm Ø80mm

340ml



PROMOTIONALS

53504

38,00€



TROTINETE DE 2 RODAS - SCOOTER



14975

64,00€

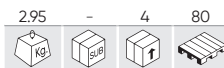

SUPORE DE PRESUNTO



GANCHO

REF. PARA	KG	SUB	UN	PAQ	€
14034 FERRAMENTAS PNEUMÁTICAS	0.20	20	80	1920	9,00€
14623 REF. 60046, 60044, 60048, 60005, 60006	0.10	-	10	800	8,00€
14626 REF. 60023	0.10	-	10	-	7,00€
11318 GANCHO PONTA COMPRIDA	0.04	20	600	-	2,50€
16364 CABIDE PONTA COMPRIDA 280MM	0.20	-	200	-	3,50€
51315 GANCHO PONTA DECHADA	0.02	20	320	44800	2,50€

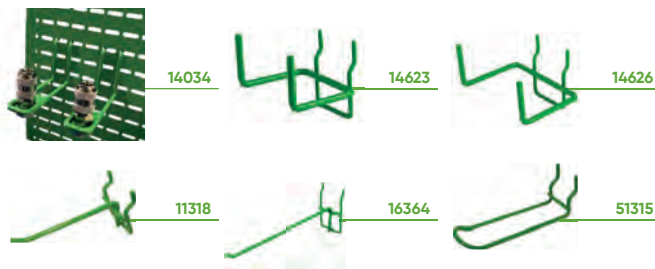

BANDEJA

REF. PARA	KG	SUB	UN	PAQ	€
14622 REF. 60001, 60003, 60004, 60020	0.95	-	10	360	17,00€
14624 REF. 60007, 60010, 60011	0.65	-	10	300	17,00€
14625 REF. 60028, 60009	0.50	-	10	700	14,00€



53492

380,00€



EXPOSITOR DE FERRAMENTA PNEUMÁTICA



EXPOSITOR SEM FERRAMENTAS



METEXP

62,00€



EXPOSITOR



REF.	DESCRIÇÃO	KG	SUB	UN	PAQ	€
13929	GANCHO DE VESTUÁRIO 49 CM	0.10	-	-	280	3,45€



53877

430,50€

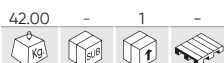

EXPOSITOR DE FERRAMENTAS

53878

574,00€



FERRAMENTA EXPOSITOR + CABEÇA COM ILUMINAÇÃO

53879

838,50€



FERRAMENTA EXPOSITOR + CABEÇA COM ILUMINAÇÃO E PORTA



CONTÉM

14945	x1
14346	x1
14380	x1
11318	x20

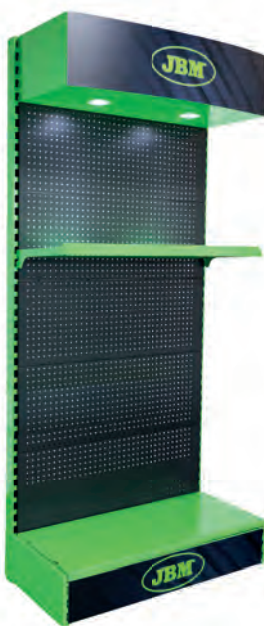

CONTÉM

14945	x1
14947	x1
14380	x1
11318	x20



CONTÉM

14945	x1
14947	x1
14948	x1
14996	x1
11318	x20



PEÇAS DE EXPOSITOR

REF.	DESCRIÇÃO					€
14945	ESTANTE DE FERRAMENTAS-BASE	37.80	-	1	15	303,50€
14946	CABEÇAL PARA EXPOSITOR DE FERRAMENTAS	3.40	-	1	51	58,00€
14947	SUPORTE LEVE DE ESTANTE DE FERRAMENTAS	8.55	-	1	6	201,50€
14948	CONJUNTO DE 2 PORTAS PARA CREMALHEIRA DE FERRAMENTAS	31.10	-	1	40	251,50€
14380	BANDEJA DE SUPORTE DE FERRAMENTAS 53877	5.00	-	1	34	51,00€
14996	BANDEJA DE SUPORTE DE FERRAMENTAS COM PORTA	5.00	-	1	33	65,00€



PROMOTIONALS

53914

75,00€

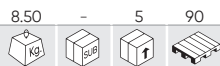

POSTE DE SEPARAÇÃO COM FITA RETRÁCTIL

- Material: aço
- Diâmetro do tubo: 63 mm
- Diâmetro da base: 320 mm
- Altura: 910 mm
- Fita de 4 lados
- Comprimento da correia: 3 m
- Largura da correia: 48 mm



14807

11,00€

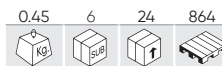

SELO DE GARANTIA JBM



TODOS OS IDIOMAS NO MESMO SELO

- 75mm de lar. x 125m de comp.
- Feito de polipropileno
- Adesivo solvente
- Espessura: 28 microns

CAIXA DE PAPELÃO JBM

CAIXA DE FERRAMENTAS MANUAIS DE REPOSIÇÃO

REF. DESCRIÇÃO				€
14922 CAIXA DE FERRAMENTAS DE MÃO PARA PEÇAS 14,5X9X10CM	0.10	100	-	0,84€
14923 CAIXA DE FERRAMENTAS MANUAIS DE REPOSIÇÃO 17,5 X 9 X 7 CM	0.10	100	-	0,84€
14924 CAIXA DE FERRAMENTAS DE MÃO PARA PEÇAS 24X11X7CM	0.10	100	-	0,84€
14925 CAIXA DE FERRAMENTAS DE MÃO PARA PEÇAS 31,5X13X4CM	0.10	100	-	0,84€
14926 CAIXA DE FERRAMENTAS DE MÃO PARA PEÇAS 32X8,5X7CM	0.10	100	-	1,05€



CAIXA PROMOCIONAL

REF. DESCRIÇÃO				€
13717 CAIXA PARA PRESUNTO 76X14X29CM	0.90	1	200	7,65€
14083 CAIXA DE CARTÃO VERDE PROMO JBM 80X28X49CM	1.80	1	100	13,20€
14976 CAIXA DE CARTÃO DE PUBLICIDADE 80X31X61 CM	2.20	1	80	18,84€
15056 CAIXA DE CARTÃO DE PUBLICIDADE, 40X30X61 CM	1.60	1	70	11,70€









CAIXA JBM

REF. DESCRIÇÃO				€
11330 PEQUENA CAIXA DE CARTÃO JBM 19X10X11CM (FOLES)	0.05	50	4200	0,57€
12950 CAIXA DE CARTÃO JBM 60X40X30CM	0.80	15	75	3,45€
12952 CAIXA DE CARTÃO JBM 40X30X20CM	0.40	20	240	1,92€
13217 CAIXA DE CARTÃO JBM 57X30X25CM (KITS DE EMERGÊNCIA)	0.55	15	150	1,31€
14974 CAIXA DE CARTÃO JBM 54X24X40CM (20 KITS DE FOLES)	0.65	20	240	2,28€
15051 CAIXA DE CARTÃO 40X32X30 CM	0.40	20	160	1,92€
14189 CONTAINER DE PALLET AMERICANO DE TRIPLO CANAL	10.00	1	40	52,00€
14507 CONTAINER DE PALLET EUROPEU	8.00	1	40	50,00€



















LEGENDA











LOGÍSTICA

 PESO EM QUILOGRAMAS	 QUANTIDADE PARA A CAIXA INTERNA	 QUANTIDADE POR CAIXA	 QUANTIDADE POR PALETE
 QUANTIDADE POR SACO	 QUANTIDADE POR KIT	 APRESENTAÇÃO EM EXPOSITOR	

GERAL

 NÚMERO DE PEÇAS	 APRESENTAÇÃO EM BLISTER	 MAGNÉTICO	 TÁTIL
 CAPACIDADE DE CARGA DA BATERIA	 DURAÇÃO DA CARGA	 CABO ERGONÔMICO	 NÃO PODE SER LAVADO
 PROTEGER CONTRA A CHUVA E UMIDADE	 PRODUTO RECICLÁVEL	 INFORMAÇÕES	 SEM FIO
 CARRO ELÉTRICO	 PLACAS DE ALTA TENSÃO	 EURO REGULAMENTO EUROPEU	 US REGULAMENTO AMERICANO
 UNIVERSAL REGULAMENTO UNIVERSAL			



















UNIDADES DE MEDIÇÃO

 COMPRIMENTO	 MASSA	 DIÂMETRO	 OUTROS
 CAPACIDADE	 POLEGADAS	 MÁXIMO - MÍNIMO	 GRAUS
 ÁREA	 GRAUS CELSIUS	 SOM	

UNIDADES DE MEDIÇÃO PARA ITENS ESPECÍFICOS

 DIÂMETRO DO DISCO	 DIÂMETRO DO ORIFÍCIO DO DISCO EM "	 DIÂMETRO DO TUBO	 DIÂMETRO INTERNO E EXTERNO DO TUBO
 COMPRIMENTO DA MANGUEIRA	 COMPRIMENTO DO PLUGUE		

MATERIAL

 MADEIRA	 AÇO	 AÇO S2	 ALUMÍNIO
 COBRE	 CROMADO	 CROMO VANÁDIO	 CROMO-MOLIBDÊNIO
 NEODÍMIO	 ZINCO	 POLICLORETO DE VINILA	 POLIPROPILENO
 POLIETILENO	 POLIETILENO DE ALTA DENSIDADE	 AÇO LAMINADO	 LATÃO
 LÁTEX	 NYLON	 BORRACHA DE ACRILONITRILO HIDROGENADO	















VOCE TAMBÉM PODE ENCONTRAR

 ALVENARIA	 MADEIRA	 AÇO
--	---	---

ESPECIFICAÇÕES TÉCNICAS

FERRAMENTAS MANUAIS

PONTAS

	PONTAS COM RANHURA		PONTAS PHILIPS		PONTAS POZIDRIV		PONTAS DE TORQUE
	PONTAS NERVURADAS		BROCA DE QUATRO PONTAS		BROCA DE TRÊS PONTAS		PONTA ALLEN
	PONTA DE TORQUE		BROCA DE 12 PONTAS		PONTA QUADRADA		BROCA DE TORQUE DE CINCO PONTAS
	PONTO DE RANHURA		PONTA BORBOLETA		PONTA ALLEN INVIOLÁVEL		PONTA DE TORQUE INVIOLÁVEL
	BROCA DE 12 PONTAS INVIOLÁVEL		PONTA QUADRADA INVIOLÁVEL		BROCA DE TORQUE DE CINCO PONTAS INVIOLÁVEL		PONTO DE RANHURA INVIOLÁVEL
	PONTA DE TRAÇÃO						

SOQUETES

	SOQUETE SEXTAVADO		SOQUETE DE TORQUE		SOQUETE DE 12 PONTAS		SOQUETE QUADRADO
	SOQUETE DE 5 PONTAS		SOQUETE ESTRIADO		SOQUETE SEXTAVADO INVIOLÁVEL		SOQUETE DE TORQUE INVIOLÁVEL
	SOQUETE DE 12 PONTAS INVIOLÁVEL		SOQUETE QUADRADO INVIOLÁVEL		SOQUETE DE CINCO PONTAS INVIOLÁVEL		SOQUETE ESTRIADO INVIOLÁVEL

CHAVES

	CHAVE SEXTAVADA		CHAVES DE TORQUE		CHAVE DODECAGONAL		CHAVE QUADRADA
	CHAVE DE CINCO PONTAS						



















CATRACA

	24 DENTES		72 DENTES		90 DENTES
---	-----------	---	-----------	---	-----------

FERRAMENTAS ELÉTRICAS

	WATTS		VÁTIOS		HERTZ		KILOVATIO
	AMPERES		CORRENTE ALTERNADA		CORRENTE CONTÍNUA		RESISTÊNCIA ELÉTRICA
	BATERIA DE ION DE LÍTIO		MICRO USB		PLUGUE DO ACENDEADOR		

FERRAMENTAS PNEUMÁTICAS

	LIBRAS POR POLEGADAS QUADRADAS (PRESSÃO)		UNIDADE DE PRESSÃO		PÉS CÚBICOS POR MINUTO (VAZÃO)		CAVALO-FORÇA (POTÊNCIA)
	REVOLUÇÕES GERAIS POR MINUTO		REVOLUÇÕES INVERSAS POR MINUTO		REVOLUÇÕES À FRENTE POR MINUTO		NEWTON POR METRO MÁXIMO
	NEWTON POR METRO		PULSOS POR MINUTO		QUILOPASCAL		MEGAPASCAL
	ALTO VOLUME DE AR E BAIXA PRESSÃO		SAÍDA TRASEIRA		CONECTÁVEL À MANGUEIRA		ENTRADA DE AR
	CAPACIDADE DE VELOCIDADE		MECANISMO DE IMPACTO TIPO JUMBO HAMMER		MECANISMO DOUBLE HAMMER		

INDICE NUMERICO

REF.	PÁGINA	PREÇO
10000	305	7,00 €
10054	232	2,90 €
10055	232	3,90 €
10264	53	2,00 €
10485	231	8,10 €
10486	231	8,00 €
10494	231	6,50 €
10495	231	3,00 €
10496	231	3,00 €
10497	231	3,00 €
10498	231	3,00 €
10499	231	3,00 €
10500	231	3,00 €
10501	231	8,10 €
10502	231	3,50 €
10526	57	10,00 €
10531	41	3,00 €
10532	41	2,70 €
10533	41	3,00 €
10534	41	3,25 €
10535	41	3,50 €
10536	41	3,65 €
10537	41	3,90 €
10538	41	4,30 €
10539	41	4,75 €
10540	41	5,25 €
10541	41	5,55 €
10542	41	5,85 €
10543	41	7,00 €
10544	41	8,10 €
10545	41	9,75 €
10546	41	11,60 €
10547	41	13,50 €
10548	41	1,75 €
10549	41	2,00 €
10550	41	2,15 €
10551	41	2,15 €
10552	38	7,10 €
10553	38	7,35 €
10554	38	7,50 €
10555	38	7,80 €
10556	38	8,10 €
10557	38	8,10 €
10558	38	9,35 €
10559	38	9,50 €
10560	38	10,60 €
10561	38	11,00 €
10562	38	12,30 €
10563	38	12,50 €
10564	42	2,50 €
10565	42	3,50 €
10566	42	3,50 €
10567	42	3,50 €

REF.	PÁGINA	PREÇO
10568	42	4,00 €
10569	42	4,50 €
10570	42	4,50 €
10571	42	5,00 €
10579	42	3,00 €
10580	42	3,10 €
10581	42	3,40 €
10582	42	4,00 €
10583	42	4,15 €
10584	42	5,05 €
10585	42	6,75 €
10586	42	7,60 €
10587	42	9,80 €
10588	42	10,50 €
10589	42	2,00 €
10590	42	2,40 €
10591	44	2,50 €
10592	44	2,55 €
10593	44	3,15 €
10594	44	3,20 €
10595	44	3,35 €
10596	44	4,25 €
10597	44	4,50 €
10598	44	4,60 €
10599	44	6,00 €
10600	44	6,25 €
10601	44	6,50 €
10602	44	7,05 €
10603	44	2,10 €
10604	44	2,25 €
10617	46	14,10 €
10618	46	15,10 €
10619	46	15,70 €
10620	46	16,20 €
10621	46	9,50 €
10622	46	10,00 €
10623	46	12,60 €
10624	46	13,50 €
10625	46	15,70 €
10626	46	17,80 €
10627	44	2,80 €
10628	44	3,10 €
10629	44	3,65 €
10630	44	3,90 €
10631	44	4,20 €
10632	44	5,30 €
10633	44	6,60 €
10634	44	7,80 €
10635	44	8,15 €
10636	44	8,80 €
10637	44	12,10 €
10638	44	12,70 €
10642	57	10,00 €

REF.	PÁGINA	PREÇO
10643	57	10,00 €
10644	57	10,00 €
10672	242	9,50 €
10673	242	9,50 €
10674	242	9,50 €
10675	242	9,50 €
10732	89	18,70 €
10735	89	20,30 €
10750	139	13,00 €
10751	139	15,00 €
10766	139, 357	1,59 €
10772	386	0,05 €
10773	386	0,10 €
10774	386	0,10 €
10775	386	0,15 €
10776	386	0,20 €
10777	386	0,20 €
10778	386	0,35 €
10779	385, 386	0,05 €
10780	385, 386	0,05 €
10781	385, 386	0,05 €
10782	386	0,05 €
10783	386	0,05 €
10784	385, 386	0,05 €
10785	385, 386	0,10 €
10786	385, 386	0,15 €
10787	386	0,05 €
10788	386	0,05 €
10789	386	0,05 €
10790	386	0,05 €
10791	386	0,05 €
10792	386	0,05 €
10793	382	0,25 €
10794	382	0,40 €
10795	382	0,60 €
10796	382	0,07 €
10797	382	0,09 €
10798	382	0,12 €
10799	382	0,13 €
10800	382	0,15 €
10801	382	0,17 €
10802	382	0,19 €
10803	382	0,05 €
10804	382	0,22 €
10805	385	0,10 €
10812	385	0,30 €
10813	385	0,30 €
10823	388	0,20 €
10824	388	0,20 €
10825	388	0,20 €
10826	388	0,40 €
10827	388	0,60 €
10828	388	0,45 €

REF.	PÁGINA	PREÇO
10829	388	0,20 €
10830	388	0,20 €
10831	388	0,20 €
10832	388	0,20 €
10833	388	0,20 €
10834	388	0,25 €
10835	388	0,25 €
10836	388	0,30 €
10837	388	0,30 €
10838	388	0,30 €
10839	388	0,40 €
10840	388	0,35 €
10868	390	0,30 €
10869	390	0,30 €
10870	390	0,45 €
10871	390	0,30 €
10872	390	0,40 €
10873	390	0,45 €
10874	390	0,30 €
10875	390	0,40 €
10876	390	0,45 €
10877	384	0,25 €
10878	384	0,30 €
10879	384	0,20 €
10880	384	0,20 €
10881	384	0,25 €
10882	382	0,25 €
10883	382	0,25 €
10884	382	0,25 €
10885	394	0,20 €
10886	394	0,20 €
10887	394	0,25 €
10888	394	0,30 €
10889	394	0,30 €
10890	394	0,35 €
10891	394	0,25 €
10892	394	0,30 €
10893	394	0,25 €
10894	394	0,20 €
10895	394	0,20 €
10896	394	0,30 €
10897	394	0,30 €
10898	394	0,30 €
10899	394	0,30 €
10900	394	0,30 €
10901	394	0,25 €
10902	394	0,30 €
10905	394	0,25 €
10906	394	0,25 €
10907	394	0,25 €
10908	394	0,30 €
10909	394	0,30 €
10910	394	0,30 €

REF.	PÁGINA	PREÇO
10911	394	0,30 €
10912	394	0,25 €
10913	394	0,30 €
10914	394	0,25 €
10915	393, 394	0,25 €
10916	394	0,30 €
10917	393, 394	0,30 €
10918	393, 394	0,30 €
10919	393, 394	0,30 €
10920	393, 394	0,25 €
10921	393, 394	0,30 €
10923	134	1,10 €
10953	229	12,50 €
10955	200	11,00 €
10961	144	13,00 €
10964	190, 350	9,00 €
10965	190, 350	6,00 €
10966	190, 350	13,50 €
11103	139	6,00 €
11106	202	3,00 €
11107	144	4,50 €
11121	168, 169, 176	4,10 €
11122	168, 169, 176	5,45 €
11123	168, 176	6,50 €
11124	176	7,65 €
11125	176	8,50 €
11126	176	11,20 €
11127	176	13,80 €
11128	176	14,10 €
11129	176	14,10 €
11130	176	13,10 €
11131	176	14,10 €
11132	176	13,70 €
11133	176	12,00 €
11134	176	15,00 €
11135	176	17,20 €
11136	176	15,30 €
11137	176	18,20 €
11138	176	18,00 €
11139	176	18,80 €
11140	176	20,40 €
11141	176	18,60 €
11142	176	21,30 €
11143	176	26,40 €
11144	176	33,30 €
11145	176	35,30 €
11146	176	37,30 €
11147	176	41,00 €
11148	176	47,00 €
11149	176	45,00 €
11150	176	55,00 €
11151	176	57,00 €
11152	176	57,00 €
11153	172, 176	23,40 €
11154	176	21,70 €
11155	172, 176	24,40 €

REF.	PÁGINA	PREÇO
11156	176	28,90 €
11157	176	26,60 €
11158	172, 176	28,50 €
11159	176	30,30 €
11160	176	27,00 €
11161	176	32,30 €
11162	176	29,10 €
11163	176	32,70 €
11164	176	30,70 €
11165	176	34,60 €
11166	176	30,90 €
11167	176	38,00 €
11168	176	41,00 €
11169	176	39,20 €
11170	176	40,00 €
11171	176	51,00 €
11172	176	48,00 €
11173	176	47,00 €
11174	176	47,00 €
11175	176	49,00 €
11176	176	56,00 €
11177	176	55,00 €
11178	176	53,00 €
11179	176	65,00 €
11180	176	59,00 €
11181	176	65,00 €
11182	176	73,00 €
11183	176	70,00 €
11184	176	87,00 €
11185	176	97,00 €
11186	176	91,00 €
11187	176	98,00 €
11188	176	103,00 €
11189	176	121,00 €
11190	176	138,00 €
11191	176	149,00 €
11192	176	152,00 €
11193	176	183,00 €
11194	176	176,00 €
11195	168, 169, 176	3,70 €
11212	63	5,00 €
11213	63	10,60 €
11214	63	12,50 €
11244	45	8,50 €
11245	45	9,15 €
11246	45	12,40 €
11247	45	14,00 €
11248	45	14,60 €
11249	45	26,50 €
11258	43	7,30 €
11259	43	8,30 €
11260	43	9,75 €
11261	43	11,35 €
11262	43	13,50 €
11314	173	8,50 €
11315	173	8,50 €
11316	173	8,50 €

REF.	PÁGINA	PREÇO
11318	410	2,50 €
11324	139	17,50 €
11325	139	17,50 €
11328	355	4,00 €
11330	412	0,57 €
11360	32	2,60 €
11361	32	3,20 €
11362	32	5,20 €
11363	32	3,90 €
11364	32	4,50 €
11365	32	9,40 €
11374	200	5,50 €
11375	200	6,50 €
11376	200	5,50 €
11377	200	5,50 €
11378	200	6,50 €
11379	200	6,00 €
11380	200	6,50 €
11381	200	6,50 €
11382	200	6,00 €
11383	200	6,00 €
11384	200	6,00 €
11385	200	5,50 €
11386	200	6,00 €
11387	200	6,00 €
11388	200	6,00 €
11389	200	6,00 €
11390	200	6,00 €
11391	200	6,50 €
11392	200	6,00 €
11393	200	6,00 €
11394	200	6,00 €
11434	226	12,00 €
11435	226	12,00 €
11436	226	12,00 €
11437	226	12,00 €
11438	226	12,00 €
11439	226	12,00 €
11440	226	12,00 €
11441	226	12,00 €
11442	226	12,00 €
11443	227	14,00 €
11444	227	14,00 €
11445	227	15,00 €
11446	227	15,00 €
11447	227	15,50 €
11450	226	12,00 €
11541	180	11,00 €
11542	180	11,00 €
11543	180	11,00 €
11544	180	7,00 €
11545	180	11,00 €
11546	180	12,00 €
11547	180	12,00 €
11613	176	11,00 €
11614	176	13,00 €
11615	176	14,20 €

REF.	PÁGINA	PREÇO
11616	176	18,10 €
11617	176	18,70 €
11618	176	18,80 €
11619	176	19,50 €
11621	176	290,00 €
11622	176	399,00 €
11623	176	489,00 €
11624	176	189,00 €
11625	176	282,00 €
11628	173	9,50 €
11639	43	4,00 €
11640	43	4,50 €
11641	43	5,00 €
11642	43	5,00 €
11643	43	6,00 €
11644	43	7,00 €
11645	43	7,00 €
11646	43	9,45 €
11867	308	9,00 €
11878	214	4,10 €
11879	214	5,10 €
11880	214	10,50 €
11890	359	0,55 €
11891	359	0,50 €
11893	211	7,00 €
11894	211	7,00 €
11895	211	8,65 €
11896	211	8,80 €
11897	190, 351	155,00 €
11900	370	3,50 €
11901	370	2,50 €
11902	370	3,50 €
11903	370	5,00 €
11904	370	2,00 €
11905	370	1,50 €
11906	370	8,50 €
11907	370	11,00 €
11936	202	4,00 €
11937	202	5,00 €
11938	174	47,00 €
11945	53	7,00 €
11946	53	4,50 €
11947	53	19,00 €
11956	152	5,50 €
11957	152	5,50 €
11959	189	10,50 €
11960	369, 370	1,50 €
11962	32, 168, 169, 175	7,50 €
11963	175	9,00 €
11964	32, 175	12,50 €
11965	175	16,00 €
11966	175	18,00 €
11967	175	18,00 €
11971	99	3,60 €
11974	339	1,80 €
11975	339	1,80 €
11976	339	1,80 €

REF.	PÁGINA	PREÇO
11977	339	1,80 €
11978	339	1,80 €
11979	339	1,80 €
11980	339	1,80 €
11981	339	1,80 €
11982	339	1,80 €
11983	339	1,80 €
11989	144	2,00 €
11990	168, 169, 174	15,30 €
11994	89	33,00 €
11996	88	48,00 €
11997	88	39,00 €
11998	88	49,00 €
12009	162	11,00 €
12022	188	33,70 €
12029	35	5,50 €
12030	35	6,50 €
12044	305	147,00 €
12055	351	20,00 €
12060	64	2,50 €
12061	169, 170, 176	9,50 €
12062	169, 170, 176	9,50 €
12063	169, 170, 176	9,50 €
12064	169, 176	9,00 €
12065	169, 170, 176	9,00 €
12066	169, 170, 172, 176	9,00 €
12067	169, 176	9,50 €
12068	169, 170, 172, 176	9,50 €
12069	169, 170, 172, 176	9,50 €
12070	169, 170, 176	10,50 €
12071	169, 170, 176	11,00 €
12072	169, 176	12,00 €
12074	169, 174	11,50 €
12075	168, 169, 174	15,50 €
12093	226	12,00 €
12200	219	14,50 €
12901	207	5,20 €
12926	241	21,50 €
12927	241	21,50 €
12928	241	22,00 €
12929	241	23,00 €
12930	241	23,50 €
12931	171	7,50 €
12932	171	7,50 €
12933	171	8,00 €
12934	171	7,50 €
12935	171	8,00 €
12936	171	8,50 €
12937	168, 169, 174	9,50 €
12938	171	10,00 €
12939	171	10,00 €
12940	171	10,00 €
12941	171	10,00 €

REF.	PÁGINA	PREÇO
12942	171	10,00 €
12943	171	10,00 €
12944	171	10,00 €
12945	171	10,50 €
12950	412	3,45 €
12952	412	1,92 €
12954	394	0,25 €
12955	180	27,80 €
12956	180	27,80 €
12957	180	27,80 €
12958	180	27,80 €
12959	180	27,80 €
12960	180	27,80 €
12961	180	27,80 €
12973	370	1,00 €
12974	196	21,00 €
12975	196	23,00 €
12977	221	36,50 €
12984	176	379,00 €
12987	152	1,50 €
12988	166	12,00 €
12995	53	7,00 €
12996	53	7,00 €
12997	53	7,50 €
12998	53	9,00 €
12999	53	9,50 €
13002	396	1,45 €
13003	396	1,70 €
13004	396	1,85 €
13005	396	1,25 €
13006	396	1,40 €
13007	396	1,30 €
13008	396	2,25 €
13009	396	1,65 €
13010	396	1,75 €
13011	396	1,15 €
13012	396	1,80 €
13013	396	1,75 €
13014	396	1,45 €
13015	396	1,20 €
13016	396	1,15 €
13017	396	2,60 €
13018	396	1,45 €
13019	396	1,75 €
13020	396	1,70 €
13021	396	1,30 €
13022	396	2,10 €
13023	396	1,50 €
13024	396	2,45 €
13025	396	1,50 €
13026	400	1,55 €
13027	400	1,85 €
13028	400	1,45 €
13029	400	1,65 €
13030	400	2,80 €
13031	400	1,85 €
13032	400	2,00 €

REF.	PÁGINA	PREÇO
13033	400	1,60 €
13034	400	2,65 €
13035	400	1,65 €
13036	400	1,40 €
13037	400	2,10 €
13038	398	1,40 €
13039	398	1,65 €
13040	398	1,80 €
13041	398	1,55 €
13042	398	1,95 €
13043	398	1,20 €
13044	398	1,55 €
13045	398	1,20 €
13046	398	1,55 €
13047	398	1,45 €
13048	398	2,20 €
13049	398	2,05 €
13050	399	1,55 €
13051	399	1,50 €
13052	399	1,25 €
13053	399	2,80 €
13054	399	2,35 €
13055	399	3,00 €
13056	398	1,55 €
13057	398	1,50 €
13058	398	2,20 €
13059	398	2,35 €
13060	398	1,60 €
13061	398	2,65 €
13062	398	2,35 €
13063	398	1,15 €
13064	398	2,60 €
13065	398	2,00 €
13066	398	2,25 €
13067	398	2,55 €
13068	399	2,85 €
13069	399	4,55 €
13070	399	2,15 €
13071	399	2,05 €
13072	399	2,75 €
13073	399	2,10 €
13074	400	4,65 €
13075	400	5,35 €
13076	400	3,90 €
13077	400	2,55 €
13078	400	2,55 €
13079	400	3,35 €
13080	398	1,75 €
13081	398	2,30 €
13082	398	1,35 €
13083	398	1,50 €
13084	398	2,10 €
13085	398	1,60 €
13086	398	1,25 €
13087	398	3,30 €
13088	398	2,40 €
13089	398	1,70 €

REF.	PÁGINA	PREÇO
13090	398	1,70 €
13091	398	1,25 €
13092	400	1,65 €
13093	400	2,95 €
13094	400	1,50 €
13095	400	1,20 €
13096	400	1,70 €
13097	400	1,20 €
13098	400	1,65 €
13099	400	2,75 €
13100	400	1,20 €
13101	400	1,50 €
13102	400	1,60 €
13103	400	1,80 €
13104	396	1,90 €
13105	396	2,50 €
13106	396	2,00 €
13107	396	2,15 €
13108	396	1,90 €
13109	396	2,90 €
13110	396	1,85 €
13111	396	1,20 €
13112	396	1,65 €
13113	396	2,20 €
13114	396	2,20 €
13115	396	2,50 €
13116	399	5,45 €
13117	399	3,65 €
13118	399	15,90 €
13119	399	5,60 €
13120	399	5,50 €
13121	399	8,75 €
13122	399	1,95 €
13123	399	5,35 €
13124	399	8,20 €
13125	399	5,95 €
13126	399	1,55 €
13127	399	5,60 €
13128	397	1,85 €
13129	397	2,00 €
13130	397	3,75 €
13131	397	3,45 €
13132	397	2,65 €
13133	397	3,45 €
13134	397	3,95 €
13135	397	3,45 €
13136	397	2,60 €
13137	397	2,25 €
13138	397	2,85 €
13139	397	3,85 €
13140	397	2,65 €
13141	397	1,80 €
13142	397	3,10 €
13143	397	1,95 €
13144	397	2,20 €
13145	397	3,85 €
13146	397	4,50 €

REF.	PÁGINA	PREÇO
13147	397	3,10 €
13148	397	3,30 €
13149	397	3,10 €
13150	397	2,25 €
13151	397	5,35 €
13152	397	3,05 €
13153	397	3,10 €
13154	397	3,20 €
13155	397	5,60 €
13156	397	3,30 €
13157	397	3,85 €
13158	397	3,75 €
13159	397	3,20 €
13160	397	5,00 €
13161	397	3,55 €
13162	397	2,60 €
13163	397	2,80 €
13217	412	1,31 €
13226	67	4,50 €
13227	67	4,50 €
13228	67	4,50 €
13229	67	4,50 €
13230	67	4,50 €
13231	67	4,50 €
13232	67	4,50 €
13234	305	224,50 €
13235	384	0,15 €
13236	384	0,15 €
13237	384	0,15 €
13238	384	0,20 €
13239	384	0,20 €
13240	384	0,40 €
13241	384	0,55 €
13447	40	16,50 €
13448	40	17,50 €
13449	40	20,00 €
13450	40	23,00 €
13451	40	28,00 €
13452	40	29,50 €
13453	39	9,00 €
13454	39	9,50 €
13455	39	10,50 €
13456	39	11,50 €
13457	39	12,00 €
13460	39	15,00 €
13462	39	17,00 €
13463	40	5,30 €
13464	40	5,30 €
13465	38, 39, 40	5,55 €
13466	38, 39, 40	5,55 €
13467	38, 39, 40	6,00 €
13468	38, 39, 40	6,25 €
13469	38, 39, 40	6,25 €
13470	38, 39, 40	6,60 €
13471	38, 39, 40	6,90 €
13472	38, 39, 40	7,25 €
13473	38, 39, 40	8,10 €

REF.	PÁGINA	PREÇO
13474	38, 39, 40	8,70 €
13475	38, 39, 40	9,10 €
13476	38, 39, 40	9,60 €
13477	40	9,85 €
13478	40	12,20 €
13479	40	13,10 €
13480	40	15,50 €
13481	40	15,80 €
13482	40	22,10 €
13483	40	25,50 €
13484	40	27,20 €
13491	40	5,30 €
13492	40	5,35 €
13493	40	5,50 €
13494	40	6,00 €
13495	40	6,40 €
13496	40	6,60 €
13497	40	7,50 €
13498	40	8,50 €
13499	162	12,50 €
13500	162	12,90 €
13667	66, 89	17,60 €
13668	88	18,70 €
13674	68, 383	0,50 €
13675	68, 383	0,50 €
13676	68, 383	0,50 €
13677	68, 383	0,50 €
13678	68, 383	0,50 €
13680	174	15,50 €
13681	174	15,50 €
13682	174	15,50 €
13683	174	15,50 €
13684	174	15,50 €
13685	174	15,50 €
13686	174	15,50 €
13687	174	15,50 €
13688	174	15,50 €
13689	174	15,50 €
13704	69	21,00 €
13707	59	14,00 €
13708	59	14,00 €
13709	59	14,00 €
13710	59	14,00 €
13712	59	14,00 €
13717	412	7,65 €
13723	176	18,50 €
13724	176	19,20 €
13725	176	19,20 €
13726	176	19,00 €
13727	176	18,70 €
13728	176	18,50 €
13729	176	22,00 €
13730	176	22,00 €
13731	176	21,60 €
13732	176	23,80 €
13733	176	24,90 €
13734	176	25,70 €

REF.	PÁGINA	PREÇO
13735	176	25,80 €
13736	176	25,90 €
13738	360	3,50 €
13739	360	5,50 €
13740	360	5,50 €
13741	372	21,00 €
13745	176	25,20 €
13746	176	25,40 €
13747	176	25,40 €
13748	176	24,90 €
13805	370	10,50 €
13806	370	10,50 €
13809	166	18,50 €
13810	166	20,50 €
13813	185	7,00 €
13814	185	11,00 €
13817	151	17,00 €
13818	151	20,50 €
13819	388	6,50 €
13820	388	7,00 €
13821	388	14,00 €
13822	388	11,00 €
13823	388	6,00 €
13824	388	8,00 €
13825	388	11,50 €
13826	388	13,00 €
13827	388	15,00 €
13828	388	11,50 €
13829	388	10,50 €
13830	388	10,50 €
13831	388	12,60 €
13832	388	13,00 €
13833	388	9,00 €
13839	144	8,50 €
13842	180	8,50 €
13843	180	7,00 €
13844	180	9,00 €
13845	180	8,00 €
13856	202	7,80 €
13859	172	16,00 €
13874	172	17,50 €
13875	172	18,50 €
13876	172	18,50 €
13877	172	18,50 €
13879	360	1,38 €
13880	360	1,50 €
13923	89	7,45 €
13929	406, 410	3,45 €
13930	165	1,50 €
13931	165	2,50 €
13932	165	2,50 €
13933	165	2,00 €
13934	165	2,50 €
13935	165	2,50 €
13936	165	3,50 €
13937	165	4,00 €
13938	165	3,50 €

REF.	PÁGINA	PREÇO
13939	165	4,00 €
13945	387	7,40 €
13946	387	6,70 €
13947	387	5,85 €
13948	387	5,00 €
13949	387	6,50 €
13950	387	7,80 €
13951	387	5,15 €
13952	387	10,90 €
13953	387	8,00 €
13954	387	12,70 €
13955	387	4,95 €
13956	387	4,30 €
13957	387	9,70 €
13958	387	5,45 €
13959	387	10,10 €
13960	387	9,65 €
13961	387	9,25 €
13962	387	1,76 €
13963	387	12,40 €
13964	387	15,00 €
13965	387	1,50 €
13966	387	12,90 €
13967	387	4,65 €
13968	409	1,35 €
13969	204	19,00 €
13982	303	4,00 €
14004	171	9,50 €
14005	171	10,50 €
14006	171	9,50 €
14007	171	9,50 €
14008	171	9,50 €
14009	171	9,50 €
14010	171	11,00 €
14011	171	11,00 €
14013	152	3,50 €
14026	53	5,50 €
14027	53	5,60 €
14029	53	8,50 €
14030	53	9,50 €
14031	131, 144	7,90 €
14032	144	12,00 €
14033	144	4,50 €
14034	410	9,00 €
14049	237	8,00 €
14050	237	10,50 €
14051	237	18,00 €
14052	237	19,50 €
14075	165	2,00 €
14076	165	1,50 €
14077	165	4,50 €
14078	165	4,00 €
14083	412	13,20 €
14114	89	19,30 €
14118	365	26,00 €
14120	146	22,00 €
14121	146	26,00 €

REF.	PÁGINA	PREÇO
14122	148	34,00 €
14123	148	33,00 €
14124	150	20,50 €
14125	150	19,50 €
14126	153	54,00 €
14127	155	32,50 €
14129	151	12,50 €
14130	151	21,00 €
14131	149	24,00 €
14133	155	16,50 €
14135	155	12,50 €
14136	152	12,00 €
14137	159	131,00 €
14145	328	8,50 €
14146	328	8,00 €
14147	328	25,00 €
14148	328	25,00 €
14153	149	20,50 €
14154	153	42,00 €
14157	161	8,30 €
14158	161	9,95 €
14159	161	12,60 €
14160	161	12,80 €
14161	161	13,70 €
14162	153	25,50 €
14163	153	25,50 €
14164	153	25,50 €
14165	146	26,50 €
14167	70	2,50 €
14168	160	7,00 €
14169	163	3,00 €
14172	173	8,50 €
14173	173	9,50 €
14177	173	9,50 €
14178	173	9,50 €
14179	58	8,50 €
14180	58	7,90 €
14183	68	31,00 €
14187	219	6,00 €
14188	160	0,50 €
14189	412	52,00 €
14190	165	2,00 €
14191	165	2,00 €
14192	165	4,00 €
14193	165	4,00 €
14195	166	4,00 €
14196	166	4,00 €
14197	166	4,50 €
14198	166	4,00 €
14199	166	4,00 €
14200	166	4,50 €
14201	165	4,00 €
14202	165	4,00 €
14203	165	4,50 €
14204	165	1,50 €
14205	165	1,50 €
14206	165	1,50 €

REF.	PÁGINA	PREÇO
14207	165	1,50 €
14208	165	1,50 €
14209	165	1,50 €
14211	237	11,00 €
14212	237	12,00 €
14213	237	12,00 €
14214	237	14,00 €
14286	153	2,99 €
14287	153	2,99 €
14288	153	6,00 €
14289	153	6,10 €
14296	74, 75, 76, 77, 83	118,00 €
14297	74, 75, 76, 77, 83	87,00 €
14298	74, 75, 76, 77, 83	51,50 €
14299	74, 75, 76, 77, 83	87,00 €
14300	220	19,00 €
14301	220	19,00 €
14314	166	5,00 €
14315	166	4,50 €
14330	153	3,50 €
14336	149	58,00 €
14340	237	10,50 €
14341	237	10,50 €
14342	237	10,50 €
14343	237	10,50 €
14344	237	11,00 €
14345	237	11,00 €
14346	237	11,00 €
14347	408	36,50 €
14348	212	12,50 €
14349	212	20,50 €
14350	403, 404	1,80 €
14351	404	1,65 €
14352	404	1,30 €
14353	404	2,10 €
14354	90	14,00 €
14355	404	1,70 €
14356	404	1,90 €
14357	404	1,90 €
14358	403, 404	1,70 €
14359	401, 404	1,05 €
14361	404	1,70 €
14364	404	1,90 €
14365	404	1,90 €
14366	404	1,45 €
14367	404	1,30 €
14368	404	1,45 €
14369	404	4,95 €
14370	404	3,00 €
14371	404	3,00 €
14372	404	1,20 €
14373	404	1,35 €
14374	403	1,70 €
14375	403	1,85 €
14376	403	2,60 €
14377	403	1,90 €

REF.	PÁGINA	PREÇO
14378	403	1,90 €
14379	403	1,45 €
14380	411	51,00 €
14381	403	1,70 €
14382	403	1,85 €
14383	403	1,35 €
14384	403	2,10 €
14387	403	1,45 €
14388	403	2,05 €
14389	403	1,25 €
14390	403	1,35 €
14391	403	2,15 €
14392	403	1,35 €
14393	403	1,50 €
14395	403	1,65 €
14396	403	1,20 €
14397	403	1,45 €
14398	403	1,30 €
14399	403	1,90 €
14402	403	1,50 €
14404	403	2,10 €
14405	403	1,45 €
14406	403	1,55 €
14408	403	1,45 €
14409	403	1,35 €
14410	402	1,85 €
14411	402	1,70 €
14412	402	1,70 €
14413	402	3,25 €
14414	402	1,70 €
14415	402	1,70 €
14416	402, 403	1,25 €
14419	402	1,95 €
14420	402	1,50 €
14421	402	2,45 €
14422	401, 402	1,50 €
14423	402	3,55 €
14424	402	1,85 €
14425	402	2,05 €
14426	402	1,90 €
14427	402	1,20 €
14428	402	1,40 €
14429	402	1,80 €
14430	402	2,25 €
14431	402	1,45 €
14432	402	1,45 €
14434	402	1,60 €
14435	402	1,45 €
14436	402	1,70 €
14437	402	1,45 €
14438	402	1,35 €
14439	402	1,75 €
14440	402	1,75 €
14441	402	1,65 €
14442	402	1,45 €
14443	402	1,45 €
14444	402	1,90 €

REF.	PÁGINA	PREÇO
14445	402	1,45 €
14446	401	2,80 €
14447	401	1,45 €
14448	401	2,05 €
14449	401	2,20 €
14450	401	2,15 €
14451	401	2,15 €
14452	401	2,55 €
14453	401	3,05 €
14455	401	2,10 €
14456	401	1,35 €
14457	401	1,70 €
14458	401	1,70 €
14459	401	1,45 €
14460	401	1,15 €
14461	401	1,35 €
14462	401	1,65 €
14463	401	1,65 €
14464	401	1,50 €
14465	401	2,00 €
14466	401	1,65 €
14468	401	1,30 €
14469	401	1,45 €
14471	401	1,90 €
14472	401	1,35 €
14474	401	1,50 €
14475	401	1,65 €
14476	401	2,05 €
14477	401	2,45 €
14478	401	4,05 €
14479	401	1,65 €
14480	401	2,05 €
14481	401	1,70 €
14507	412	50,00 €
14534	161	16,50 €
14560	161	8,80 €
14561	166	8,80 €
14563	214	18,00 €
14564	183	9,20 €
14565	183	26,70 €
14566	183	16,70 €
14567	183	38,00 €
14568	183	9,20 €
14569	183	9,20 €
14570	183	4,05 €
14571	183	9,20 €
14573	183	4,05 €
14578	92	12,50 €
14580	92	41,00 €
14583	148	6,00 €
14594	221, 389	2,00 €
14595	221, 389	1,50 €
14596	221, 389	2,00 €
14597	221, 389	7,60 €
14598	221, 389	17,80 €
14599	221, 389	4,50 €
14600	221, 389	9,50 €

REF.	PÁGINA	PREÇO
14601	221, 389	11,00 €
14602	221, 389	11,00 €
14611	240	12,00 €
14612	240	11,00 €
14613	240	13,50 €
14616	321	96,00 €
14618	147	19,00 €
14622	123, 410	17,00 €
14623	123, 410	8,00 €
14624	123, 410	17,00 €
14625	123, 410	14,00 €
14626	123, 410	7,00 €
14633	147	22,50 €
14710	183	3,50 €
14711	183	3,75 €
14712	183	4,00 €
14713	183	4,25 €
14714	183	4,50 €
14715	183	4,75 €
14723	172	18,00 €
14724	172	18,50 €
14725	172	18,50 €
14726	172	17,50 €
14728	168, 169, 176	3,80 €
14729	168, 169, 176	3,80 €
14730	168, 169, 176	3,80 €
14731	168, 169, 176	3,80 €
14732	168, 169, 176	3,80 €
14733	168, 169, 176	4,30 €
14734	168, 169, 176	5,40 €
14735	169	6,50 €
14736	170, 176	5,00 €
14737	170, 176	5,00 €
14738	170, 176	5,50 €
14739	170, 176	5,50 €
14740	170, 176	5,55 €
14741	170, 176	5,55 €
14742	170, 176	5,55 €
14743	170, 176	5,15 €
14744	170, 176	5,35 €
14745	170, 176	6,25 €
14746	170, 176	6,40 €
14747	170, 176	7,10 €
14748	170, 176	8,30 €
14749	32, 175	2,00 €
14750	32, 175	2,00 €
14751	32, 175	4,00 €
14752	32, 175	4,00 €
14753	143	13,00 €
14771	164, 338	10,50 €
14772	164	8,50 €
14774	338	10,50 €
14775	380	30,50 €
14779	150	33,00 €
14781	377	9,90 €

REF.	PÁGINA	PREÇO
14783	92	5,50 €
14793	378	12,00 €
14803	380	43,00 €
14807	412	11,00 €
14825	123	1,50 €
14826	123	1,50 €
14827	123	2,00 €
14828	123	1,50 €
14829	123	1,50 €
14830	123	1,50 €
14831	123	1,50 €
14832	123	2,00 €
14833	123	2,05 €
14834	123	2,50 €
14835	123	3,00 €
14836	123	3,50 €
14837	123	3,30 €
14838	123	3,40 €
14839	123	4,70 €
14840	123	3,35 €
14841	124	2,58 €
14842	124	9,50 €
14843	125	0,50 €
14844	125	0,50 €
14845	125	0,50 €
14846	125	0,50 €
14847	125	0,50 €
14848	125	0,50 €
14849	125	1,00 €
14850	125	1,00 €
14851	125	1,00 €
14852	125	1,00 €
14853	125	1,00 €
14854	125	1,00 €
14855	125	1,00 €
14856	125	1,00 €
14857	125	1,50 €
14858	125	1,50 €
14859	125	1,50 €
14860	125	2,00 €
14861	125	2,00 €
14862	125	2,00 €
14863	125	2,50 €
14864	125	2,50 €
14865	125	2,50 €
14866	125	3,00 €
14867	125	3,00 €
14868	125	0,55 €
14869	125	0,60 €
14870	125	1,00 €
14871	125	1,00 €
14872	125	1,00 €
14873	125	1,00 €
14874	125	1,00 €
14875	125	1,50 €
14876	125	1,50 €
14877	125	1,50 €

REF.	PÁGINA	PREÇO
14878	125	2,00 €
14879	125	2,00 €
14880	125	2,50 €
14881	125	2,50 €
14882	125	3,00 €
14883	125	3,50 €
14884	125	3,65 €
14885	125	4,00 €
14886	125	4,60 €
14887	125	5,00 €
14888	125	6,00 €
14889	125	6,50 €
14890	125	7,00 €
14891	125	7,50 €
14892	125	8,00 €
14893	128	2,00 €
14894	128	1,20 €
14895	128	1,90 €
14896	128	2,10 €
14897	128	0,88 €
14898	128	0,98 €
14899	128	0,88 €
14900	128	0,98 €
14901	124	3,60 €
14902	124	4,65 €
14903	124	5,25 €
14904	124	6,85 €
14905	124	8,50 €
14906	124	10,20 €
14907	124	0,50 €
14908	124	0,60 €
14909	124	0,80 €
14910	124	1,00 €
14911	124	1,30 €
14912	124	1,55 €
14913	124	1,90 €
14914	124	2,10 €
14915	124	2,65 €
14916	124	2,95 €
14917	124	3,45 €
14920	123	2,50 €
14922	412	0,84 €
14923	412	0,84 €
14924	412	0,84 €
14925	412	0,84 €
14926	412	1,05 €
14930	204	9,50 €
14931	204	8,00 €
14932	204	9,50 €
14933	204	9,50 €
14934	124	4,25 €
14935	124	8,45 €
14945	411	303,50 €
14946	411	58,00 €
14947	411	201,50 €
14948	411	251,50 €
14950	116	6,50 €

REF.	PÁGINA	PREÇO
14951	116	9,50 €
14952	116	19,00 €
14953	116	8,50 €
14970	168	2,50 €
14971	168	2,50 €
14972	168	3,50 €
14973	168, 169	11,50 €
14974	412	2,28 €
14975	410	64,00 €
14976	412	18,84 €
14978	53	7,50 €
14979	53	9,00 €
14980	53	13,00 €
14981	53	22,50 €
14982	53	27,50 €
14985	128	6,00 €
14986	128	4,00 €
14987	128	8,50 €
14988	128	8,00 €
14989	128	6,00 €
14990	128	10,50 €
14991	128	2,00 €
14992	200	8,50 €
14993	128	5,00 €
14994	128	3,50 €
14995	128	8,00 €
14996	411	65,00 €
15010	97	16,50 €
15011	97	18,00 €
15012	97	31,50 €
15014	127	20,00 €
15023	92	12,50 €
15024	92	15,00 €
15025	92	12,50 €
15026	92	15,00 €
15030	92	8,00 €
15033	92	6,00 €
15034	92	57,00 €
15035	92	8,50 €
15036	92	8,50 €
15037	92	8,00 €
15038	92	34,50 €
15040	92	12,50 €
15041	92	15,00 €
15042	92	7,50 €
15049	117	37,40 €
15050	92	9,50 €
15051	412	1,92 €
15052	219	3,00 €
15053	219	10,50 €
15054	219	34,00 €
15056	412	11,70 €
15058	92	7,50 €
15059	378	10,00 €
15062	378	1,00 €
15065	92	6,50 €
15068	90	15,20 €

REF.	PÁGINA	PREÇO
15069	90	32,80 €
15070	82	0,50 €
15071	82	0,60 €
15072	82	0,70 €
15073	82	1,00 €
15074	82	1,00 €
15075	82	1,20 €
15076	82	3,50 €
15083	88	8,50 €
15084	88, 203, 307	68,00 €
15093	317	38,00 €
15094	317	39,50 €
15095	317	13,00 €
15096	317	40,00 €
15122	39, 75, 85	74,00 €
15138	51	10,50 €
15139	51	12,00 €
15140	51	13,50 €
15144	93	30,00 €
15145	94	20,45 €
15146	94	16,20 €
15147	50	5,00 €
15148	50	5,00 €
15149	50	5,00 €
15152	408	160,00 €
15155	75, 85	59,00 €
15156	43, 85	70,00 €
15157	85	42,00 €
15158	85	59,00 €
15159	85	44,00 €
15160	85	42,00 €
15161	75, 85	62,00 €
15162	36, 87, 345	30,20 €
15206	43	15,00 €
15207	43	16,50 €
15208	43	17,00 €
15209	43	18,00 €
15227	36	3,50 €
15228	36	4,00 €
15229	36	5,00 €
15230	36	5,00 €
15231	36	3,50 €
15232	36	4,00 €
15233	36	5,00 €
15234	36	3,00 €
15253	222, 225	62,00 €
15300	369	5,00 €
15313	90	14,00 €
15315	86	28,20 €
15316	39, 86	58,00 €
15317	369	4,50 €
15328	39	6,00 €
15329	39	5,50 €
15330	39	5,50 €
15331	39	5,50 €
15332	39	6,00 €
15333	39	6,50 €

REF.	PÁGINA	PREÇO
15334	39	7,00 €
15335	39	7,50 €
15336	39	8,00 €
15337	39	8,50 €
15338	39	9,00 €
15339	39	9,50 €
15375	183	28,00 €
15385	135	18,00 €
15448	343	5,50 €
15454	57, 86	35,40 €
15460	343	5,00 €
15494	200	12,50 €
15495	200	12,50 €
15496	200	11,50 €
15497	200	11,00 €
15498	200	11,50 €
15499	200	11,00 €
15500	200	10,00 €
15501	200	10,00 €
15502	200	10,00 €
15503	200	11,00 €
15504	200	10,00 €
15505	200	4,00 €
15506	200	4,00 €
15507	200	4,50 €
15508	200	4,50 €
15509	200	5,00 €
15510	200	5,00 €
15511	200	8,00 €
15514	75, 86	9,35 €
15515	39	15,50 €
15516	39	19,00 €
15517	39	22,50 €
15541	86	27,60 €
15552	190, 351	181,00 €
15564	148	11,90 €
15619	355	4,00 €
15631	303	98,00 €
15632	38	9,00 €
15633	38	9,50 €
15634	38	11,00 €
15635	38	12,50 €
15636	38	14,00 €
15637	38	15,00 €
15681	85	134,00 €
15706	63, 86	31,00 €
15730	78, 84	289,00 €
15731	78, 84	214,00 €
15732	78, 84	293,50 €
15733	78, 84	113,00 €
15734	78, 84	288,50 €
15735	78, 84	152,00 €
15736	78, 84	488,50 €
15737	66, 86	45,00 €
15783	65	3,50 €
15784	65	3,50 €
15785	65	3,50 €

REF.	PÁGINA	PREÇO
15786	65	3,50 €
15787	65	3,50 €
15799	63, 87	28,30 €
15866	350	32,00 €
15874	310	6,50 €
16010	46	4,00 €
16011	46	4,00 €
16012	46	4,00 €
16013	46	4,50 €
16014	46	4,50 €
16015	46	5,00 €
16016	46	5,00 €
16017	46	5,00 €
16018	46	5,50 €
16019	46	6,00 €
16020	41	17,00 €
16021	41	19,50 €
16022	41	23,00 €
16023	41	26,50 €
16024	41	34,50 €
16025	41	37,50 €
16052	137, 144	2,09 €
16053	137, 144	2,85 €
16111	61, 87	19,20 €
16130	343	290,00 €
16161	91	17,50 €
16162	91	35,10 €
16163	91	10,20 €
16188	91	39,60 €
16198	343	5,00 €
16237	237	23,00 €
16238	237	23,00 €
16239	237	23,00 €
16240	237	26,00 €
16241	237	23,00 €
16242	237	26,00 €
16243	237	23,00 €
16273	150	12,50 €
16294	395	14,00 €
16295	206	30,00 €
16300	227	7,60 €
16301	227	7,60 €
16302	227	7,60 €
16304	172	31,00 €
16305	172	31,00 €
16309	220	149,00 €
16316	221	18,50 €
16318	126	0,50 €
16319	126	0,50 €
16320	126	0,50 €
16321	126	1,00 €
16322	126	1,00 €
16323	126	1,00 €
16324	126	1,50 €
16325	126	1,50 €
16326	126	2,00 €
16327	126	2,00 €

REF.	PÁGINA	PREÇO
16328	126	2,50 €
16329	126	3,00 €
16330	126	3,50 €
16331	126	3,50 €
16332	126	4,00 €
16333	126	4,50 €
16334	126	5,50 €
16335	126	6,00 €
16336	126	6,50 €
16341	147	32,50 €
16342	65	2,50 €
16343	65	2,50 €
16344	90	43,00 €
16354	90	1,50 €
16355	90	2,00 €
16356	90	2,50 €
16357	90	2,50 €
16358	90	12,00 €
16359	90	10,00 €
16360	90	12,00 €
16361	90	16,50 €
16362	90	20,00 €
16363	90	14,50 €
16364	123, 410	3,50 €
16366	206	11,00 €
16367	206	10,00 €
16368	206	12,00 €
16369	206	12,00 €
16370	206	12,00 €
16371	206	11,00 €
16372	206	11,50 €
16373	206	12,00 €
16374	206	12,00 €
16375	206	15,00 €
16376	206	15,00 €
16377	206	16,00 €
16378	206	15,00 €
16379	206	15,00 €
16380	206	16,00 €
16381	206	10,00 €
16382	206	10,00 €
16383	206	15,00 €
16384	206	15,00 €
16385	242	10,00 €
16386	242	11,50 €
16387	92	10,50 €
16388	242	11,50 €
16389	242	11,50 €
16391	39	4,60 €
16392	39	4,60 €
16393	39	4,60 €
16394	39	5,10 €
16395	39	5,10 €
16396	39	5,10 €
16397	39	5,50 €
16398	39	5,50 €
16399	39	5,50 €

REF.	PÁGINA	PREÇO
16400	259	6,50 €
16401	39	6,10 €
16402	39	6,10 €
16403	39	6,10 €
16430	233	20,50 €
16431	233	20,50 €
16432	233	20,50 €
16433	233	20,50 €
16434	233	20,50 €
16435	233	21,50 €
16436	233	21,50 €
16448	222	16,50 €
16462	389	36,50 €
16463	389	36,50 €
16464	389	36,50 €
16465	389	39,50 €
16466	389	50,00 €
16467	389	36,50 €
16468	389	36,50 €
16469	389	36,50 €
16470	389	39,50 €
16471	389	50,00 €
16472	389	17,50 €
16473	389	17,50 €
16474	389	17,50 €
16475	389	17,50 €
16476	389	24,00 €
16477	389	24,50 €
16478	389	24,50 €
16479	389	7,50 €
16480	389	7,50 €
16481	93	14,00 €
16482	93	13,50 €
16490	73	650,00 €
16491	73	307,00 €
16492	73	675,00 €
16493	73	436,00 €
16494	73	139,00 €
16496	73	127,00 €
16497	73	77,00 €
16498	73	84,00 €
16499	73	162,00 €
16500	73	463,00 €
16516	73	121,00 €
16538	389	19,50 €
16539	389	18,00 €
16540	389	13,00 €
16541	389	13,00 €
16542	389	23,50 €
16543	389	13,00 €
16546	43	5,00 €
16547	43	5,50 €
16548	43	9,00 €
16549	43	14,00 €
16561	73	36,50 €
16564	147	17,00 €
16565	233	19,50 €

REF.	PÁGINA	PREÇO
16566	233	22,50 €
16571	172	32,00 €
16572	172	33,50 €
16574	172	34,00 €
16575	172	34,50 €
16576	172	35,50 €
16577	172	36,00 €
16583	126	8,50 €
16584	126	10,50 €
16585	126	11,50 €
16586	126	13,00 €
16587	126	14,00 €
16588	126	15,00 €
16600	73	252,00 €
16627	73	225,00 €
16628	73	382,00 €
16629	73	419,00 €
16642	65	1,00 €
16737	226	12,00 €
50400	191	168,00 €
50403	191	98,00 €
50409	192	26,00 €
50410	191	168,00 €
50431	357	3,80 €
50517	350	129,00 €
50518	350	169,00 €
50523	357	4,70 €
50524	357	4,70 €
50525	365	1,00 €
50526	365	4,80 €
50551	357	350,00 €
50562	44	23,50 €
50564	42	30,00 €
50567	57	9,60 €
50577	186	12,60 €
50585	361	14,70 €
50600	368	0,60 €
50601	368	0,29 €
50622	46	64,00 €
50623	21	60,00 €
50630	324	590,00 €
50631	322	68,00 €
50632	335	298,00 €
50644	359	11,60 €
50651	391	18,00 €
50652	391	16,50 €
50654	354	4,00 €
50656	190, 351	290,00 €
50717	359	21,90 €
50724	69	28,00 €
50731	217	68,00 €
50751	156, 312	43,00 €
50760	368	0,10 €
50761	368	0,19 €
50762	368	0,29 €
50763	368	0,38 €
50764	368	0,49 €

REF.	PÁGINA	PREÇO
50765	368	0,58 €
50766	368	0,68 €
50767	368	0,78 €
50768	368	0,88 €
50778	368	0,10 €
50779	368	0,19 €
50780	368	0,29 €
50781	368	0,38 €
50782	368	0,49 €
50783	368	0,58 €
50784	368	0,68 €
50785	368	0,78 €
50786	368	0,88 €
50787	98	8,00 €
50788	98	14,50 €
50789	98	29,00 €
50792	236	105,00 €
50793	236	94,00 €
50797	349	490,00 €
50807	221, 391	38,00 €
50808	99	77,00 €
50815	314	88,00 €
50816	315	88,00 €
50818	314	198,00 €
50819	316	28,00 €
50820	316	34,50 €
50821	316	47,00 €
50822	316	59,00 €
50823	316	94,00 €
50824	316	88,00 €
50825	316	154,00 €
50827	223, 321	387,00 €
50830	317	560,00 €
50831	322	460,00 €
50835	319	290,00 €
50836	323	148,00 €
50838	323	299,00 €
50839	320	180,00 €
50840	322	138,00 €
50843	99	79,00 €
50844	99	65,00 €
50852	312	24,50 €
50901	181	16,00 €
50902	54	13,00 €
50903	181	30,80 €
50910	142	45,00 €
50911	324	788,00 €
50913	190, 351	195,00 €
50915	357	4,20 €
50916	192	0,88 €
50917	305	271,00 €
50918	304	341,00 €
50923	188, 320	454,00 €
50924	308, 351	342,00 €
50935	304	595,00 €
50937	69	10,50 €
50942	331, 344	28,00 €

REF.	PÁGINA	PREÇO
50957	95	22,00 €
50959	95, 386	14,00 €
50966	354	4,00 €
50966C	354	3,00 €
50980	34	22,00 €
50982	34	22,00 €
50983	30	48,00 €
50985	30	59,00 €
51017	56	6,80 €
51018	56	7,05 €
51020	56	6,65 €
51021	56	7,05 €
51028	172	163,00 €
51033	339	98,00 €
51035	94	799,00 €
51050	95	285,00 €
51051	95	34,80 €
51055	368	0,98 €
51059	195	99,00 €
51119	229	62,00 €
51120	213	41,00 €
51121	222	27,30 €
51123	229	91,00 €
51124	241	88,00 €
51125	238	88,00 €
51126	234	18,00 €
51127	52	56,00 €
51127R	52	14,00 €
51131	180	61,00 €
51140	240	64,00 €
51206	146	228,00 €
51207	146	289,00 €
51210	148	650,00 €
51211	148	560,00 €
51212	148	488,00 €
51213	148	690,00 €
51214	150	148,00 €
51215	150	119,00 €
51216	153	650,00 €
51218	155	288,00 €
51220	151	240,00 €
51221	151	199,00 €
51222	149	128,00 €
51226	155	233,00 €
51235	329	49,00 €
51238	328	138,00 €
51239	328	159,00 €
51245	155	99,00 €
51246	358	6,40 €
51253	305	41,00 €
51258	134	0,15 €
51259	231	58,00 €
51260	29	37,00 €
51262	52	51,00 €
51262R	52	14,00 €
51266	359	28,00 €
51272	62	7,50 €

REF.	PÁGINA	PREÇO
51277	157	64,00 €
51283	196	78,00 €
51305	50	28,90 €
51306	50	28,10 €
51307	50	29,70 €
51315	410	2,50 €
51318	38	98,00 €
51326	134	4,40 €
51332	200	98,00 €
51333	32	18,00 €
51336	173	29,30 €
51337	204	50,00 €
51338	52	53,00 €
51338R	52	14,00 €
51340	296	39,30 €
51341	163	35,00 €
51347	230	9,90 €
51349	242	37,30 €
51352	201	9,80 €
51353	201	11,50 €
51354	202	13,20 €
51355	60, 369	19,00 €
51356	308	48,00 €
51358	371	7,50 €
51359	371	9,00 €
51360	181	8,05 €
51361	181	9,80 €
51362	371	3,00 €
51363	328	114,00 €
51364	221	26,00 €
51365	328	118,00 €
51368	224	19,00 €
51369	224	28,00 €
51383	157	11,10 €
51385	162	4,55 €
51386	162	5,95 €
51387	162	3,25 €
51388	153	22,00 €
51389	153	22,00 €
51390	153	22,00 €
51391	153	22,00 €
51392	153	34,00 €
51393	153	34,00 €
51398N	375	1,54 €
51400	204	17,00 €
51401	204	22,00 €
51402	204	20,50 €
51403	204	17,50 €
51405	50	21,10 €
51406	50	29,20 €
51409	33	36,00 €
51410	33	36,00 €
51412	364	2,10 €
51414	224	14,00 €
51416	47	12,00 €
51419	91	2,79 €
51422	91	2,97 €

REF.	PÁGINA	PREÇO
51439	153	26,00 €
51440	153	28,00 €
51441	153	26,00 €
51442	153	28,00 €
51443	162	5,50 €
51444	162	5,05 €
51445	162	5,05 €
51447	53, 87	16,00 €
51448	53, 87	52,00 €
51452	322	69,00 €
51479	53	31,80 €
51488	273	16,00 €
51489	284	12,00 €
51490	225	36,00 €
51491	230	154,00 €
51493	207	68,00 €
51494	205	107,00 €
51495	232	59,00 €
51496	236	8,00 €
51500	240	29,00 €
51501	233	38,00 €
51504	63	8,50 €
51525	62	9,80 €
51526	62	9,80 €
51528	44	49,00 €
51538	388	0,15 €
51539	388	0,15 €
51540	388	0,15 €
51541	388	0,25 €
51542	388	0,20 €
51543	388	0,25 €
51544	388	0,25 €
51545	388	0,30 €
51546	389	0,19 €
51554	389	0,28 €
51573	134	2,50 €
51574	95	52,00 €
51575	96	317,00 €
51576	93	125,00 €
51600	96	109,00 €
51604	368	0,98 €
51612	357	5,95 €
51613	357	2,90 €
51614	357	3,60 €
51615	357	5,95 €
51616	23	378,00 €
51622	192	25,30 €
51632N	375	1,54 €
51633	375	1,54 €
51634	375	1,54 €
51636N	375	1,54 €
51638N	375	1,54 €
51640N	375	1,54 €
51642N	375	1,54 €
51653	91	5,10 €
51654	91	4,80 €
51655	91	4,10 €

REF.	PÁGINA	PREÇO
51656	91	3,65 €
51657	91	5,85 €
51658	91	4,50 €
51659	46	59,00 €
51661	47	12,00 €
51674	63	7,75 €
51692	355	3,55 €
51693	355	3,55 €
51694	355	3,55 €
51696	355	3,55 €
51697	364	0,80 €
51703	359	10,50 €
51705	359	8,45 €
51706	366	22,80 €
51707	366	9,05 €
51708	366	14,20 €
51709	366	14,70 €
51710	366	17,80 €
51711	366	21,20 €
51712	366	8,65 €
51713	366	13,10 €
51714	366	15,80 €
51715	366	20,30 €
51716	366	23,60 €
51717	366	11,20 €
51718	366	14,80 €
51719	366	22,00 €
51720	366	23,50 €
51721	366	25,00 €
51722	366	13,10 €
51723	366	18,70 €
51724	366	24,40 €
51725	366	28,30 €
51726	366	31,40 €
51727	366	49,00 €
51737	94	699,00 €
51738	93	850,00 €
51741	370	0,50 €
51742	370	0,50 €
51743	370	0,55 €
51745	376	0,70 €
51746	34	12,00 €
51751	320	99,00 €
51785	376	1,00 €
51795	47	9,00 €
51796	47	14,00 €
51797	47	18,00 €
51798	47	39,60 €
51799	389	0,20 €
51801	51	62,00 €
51804	386	58,00 €
51805	53, 87	17,00 €
51812	56	46,00 €
51814	369	8,00 €
51816	329	58,00 €
51817	354	4,50 €
51818	18	109,00 €

REF.	PÁGINA	PREÇO
51824	192	36,80 €
51830	52	94,00 €
51831	339	24,00 €
51832	181	18,00 €
51837	336	195,00 €
51838	336	667,00 €
51839	198	24,00 €
51842	330	6,90 €
51843	389	0,19 €
51853	70	18,00 €
51855	23	378,00 €
51858	364	15,00 €
51859	339	3,80 €
51861	159, 359	199,00 €
51863	366	54,00 €
51864	45, 87	64,00 €
51886	142	44,00 €
51889	130	49,00 €
51890	46	92,00 €
51895	315	99,00 €
51896	235	82,00 €
51897	235	122,00 €
51898	235	139,00 €
51899	235	137,00 €
51901	319	999,00 €
51902	229	84,00 €
51905	316	34,50 €
51906	316	39,00 €
51907	316	48,00 €
51908	368	44,00 €
51909	65	2,46 €
51918	63	12,50 €
51919	228	89,00 €
51920	234, 392	18,00 €
51923	201	12,50 €
51925	365	1,00 €
51927	296	25,00 €
51928	308	14,00 €
51929	143	22,00 €
51934	201	11,50 €
51935	354	135,00 €
51936	354	135,00 €
51937	354	135,00 €
51951	70	15,60 €
51958	228	422,00 €
51960	138	34,00 €
51961	138	34,00 €
51962	138	25,00 €
51963	138	29,00 €
51964	138	28,00 €
51965	138	29,50 €
51966	139	18,00 €
51967	144	16,00 €
51968	144	16,00 €
51969	139	14,00 €
51972	60	12,00 €
51973	366	45,00 €

REF.	PÁGINA	PREÇO
51975	91	2,27 €
51976	91	1,63 €
51978	191	84,00 €
51980	156	15,00 €
51981	157	21,50 €
51982	349	120,00 €
51983	349	185,00 €
51984	349	190,00 €
51985	191	84,00 €
51986	234	11,90 €
51989	216	49,00 €
51991	230	54,00 €
51995	58, 59	24,50 €
51998	226	38,00 €
52010	239	80,00 €
52012	228	68,00 €
52016	235	2,10 €
52017	235	2,40 €
52018	235	2,60 €
52019	235	3,20 €
52021	235	3,40 €
52022	235	4,50 €
52023	235	6,60 €
52024	235	10,60 €
52025	235	13,00 €
52026	181	31,80 €
52027	382	14,00 €
52028	385	15,20 €
52029	385	14,00 €
52030	388	98,00 €
52031	387	44,00 €
52032	386	28,00 €
52033	390	43,00 €
52043	384	16,50 €
52044	382	19,00 €
52047	357	3,30 €
52048	357	3,95 €
52049	66	14,00 €
52050	59	98,00 €
52052	57	53,00 €
52053	394	45,00 €
52054	394	17,00 €
52055	322	139,00 €
52056	242	66,00 €
52057	191	6,80 €
52058	191	4,50 €
52059	35	29,00 €
52060	35	32,00 €
52065	191	45,00 €
52066	218	12,00 €
52069	328	29,50 €
52070	328	40,00 €
52071	328	47,00 €
52076	211	111,00 €
52077	183	29,50 €
52148	99	65,00 €
52149	349	230,00 €

REF.	PÁGINA	PREÇO
52152	60	13,50 €
52153	227	46,00 €
52156	149	140,00 €
52157	155	48,00 €
52158	386	38,50 €
52159	151	64,00 €
52160	151	48,00 €
52162	79, 338, 346	38,00 €
52163	388	95,00 €
52165	149	118,00 €
52167	150	48,00 €
52169	55	25,00 €
52170	55	16,00 €
52171	155	39,00 €
52180	63	19,00 €
52181	63	22,50 €
52182	63	24,00 €
52183	63	26,20 €
52184	63	43,00 €
52185	63	55,00 €
52186	63	72,00 €
52187	364	21,80 €
52188	63	15,50 €
52190	216	8,00 €
52191	197	198,00 €
52195	334	170,00 €
52197	50	36,30 €
52198	32	37,70 €
52200	351	88,00 €
52202	351	88,00 €
52207	50	24,20 €
52227	223	247,00 €
52230	190, 350	398,00 €
52231	330	49,00 €
52233	330	328,00 €
52235	48	11,00 €
52236	48	13,30 €
52237	48	18,10 €
52238	48	24,90 €
52241	319	1.690,00 €
52242	311	12,00 €
52243	311	8,50 €
52244	191	84,00 €
52251	364	21,80 €
52254	135	64,00 €
52259	359	3,75 €
52262	185	7,50 €
52263	185	13,50 €
52264	185	18,60 €
52265	185	30,50 €
52269	202	7,00 €
52270	224	109,00 €
52271	283	18,00 €
52272	57	24,60 €
52273	212	44,00 €
52275	198	38,00 €
52293	231	98,00 €

REF.	PÁGINA	PREÇO
52295	185	6,50 €
52296	239	119,00 €
52297	239	172,00 €
52298	239	177,00 €
52302	140	25,40 €
52303	140	26,40 €
52304	316	84,00 €
52305	205	106,00 €
52308	100	440,00 €
52309	100	941,00 €
52310	375	3,65 €
52311	201	19,00 €
52312	201	9,00 €
52313	201	8,00 €
52314	201	26,60 €
52315	198	16,00 €
52316	232	18,90 €
52317	232	19,90 €
52318	69	73,00 €
52319	232	8,80 €
52320	34	22,00 €
52321	186	8,80 €
52327	186	12,00 €
52328	197	99,00 €
52329	303	36,40 €
52330	194	99,00 €
52331	159	201,00 €
52337	168	65,00 €
52338	173	41,00 €
52339	171	61,00 €
52340	171	58,00 €
52341	169	58,00 €
52342	170	63,00 €
52343	173	52,00 €
52344	171	197,00 €
52345	168	109,00 €
52346	169	103,00 €
52347	171	158,00 €
52348	172	179,00 €
52349	48	22,10 €
52350	48	22,60 €
52351	48	25,40 €
52352	48	32,40 €
52353	48	33,40 €
52354	48	34,40 €
52355	48	36,60 €
52357	48	54,00 €
52358	48	63,00 €
52362	357	1,23 €
52363	357	1,23 €
52364	357	2,86 €
52365	357	2,46 €
52368	357	1,14 €
52369	357	1,19 €
52370	357	1,17 €
52373	93	252,00 €
52375	137	38,00 €

REF.	PÁGINA	PREÇO
52378	163	10,00 €
52381	157	20,50 €
52382	331, 344	19,50 €
52384	132	29,00 €
52385	186	251,00 €
52386	186	23,60 €
52390	187	35,20 €
52391	311	5,00 €
52412	59	5,00 €
52414	141	19,00 €
52415	141	19,00 €
52416	203	14,00 €
52417	203	28,00 €
52418	21	179,00 €
52419	89	80,00 €
52420	89	108,00 €
52421	89	172,00 €
52422	213	24,70 €
52424	47	64,00 €
52425	63	33,30 €
52426	63	52,00 €
52427	63	64,00 €
52428	305	40,00 €
52430	376	10,90 €
52432	224	35,00 €
52433	69	4,80 €
52434	197	125,00 €
52439	331	227,00 €
52450	338	105,00 €
52451	43	42,00 €
52452	310	8,00 €
52453	310	21,00 €
52454	238	12,90 €
52455	198	16,00 €
52456	137	36,00 €
52460	63	16,60 €
52461	63	25,70 €
52462	68	25,30 €
52463	67	26,10 €
52464	67	42,00 €
52466	98	11,00 €
52468	62	5,90 €
52472	62	4,90 €
52473	62	9,90 €
52474	187	68,00 €
52475	187	62,00 €
52476	187	50,00 €
52477	187	70,00 €
52478	187	49,00 €
52479	187	24,70 €
52480	187	44,00 €
52481	187	52,00 €
52482	187	44,00 €
52483	187	41,00 €
52484	187	66,00 €
52485	187	51,00 €
52486	187	62,00 €

REF.	PÁGINA	PREÇO
52487	187	63,00 €
52488	211	28,00 €
52489	210	58,00 €
52490	156	6,65 €
52491	156	10,50 €
52493	378	4,50 €
52494	241	227,00 €
52495	216	14,50 €
52497	192	26,80 €
52498	308	58,00 €
52500	54	19,00 €
52502	187	31,40 €
52503	187	32,50 €
52504	187	27,60 €
52505	187	20,80 €
52506	187	16,00 €
52507	187	30,10 €
52508	59	38,40 €
52509	59	36,20 €
52511	187	42,00 €
52512	187	50,00 €
52514	320	84,00 €
52515	70, 216	9,10 €
52516	98	28,00 €
52517	98	6,00 €
52518	201	115,00 €
52519	36, 345	25,50 €
52524	53	51,00 €
52525	53	13,80 €
52526	53	28,40 €
52527	151	82,00 €
52528	155	49,00 €
52530	361	14,00 €
52533	161, 182	10,00 €
52534	361	15,00 €
52535	361	16,50 €
52536	130	57,00 €
52538	31	62,00 €
52539	31	59,00 €
52540	159, 182	221,00 €
52541	222	45,00 €
52542	99	109,00 €
52543	160	182,00 €
52544	175	93,00 €
52545	175	177,00 €
52546	171	39,60 €
52547	168	96,00 €
52550	30	92,00 €
52551	242	151,00 €
52552	372	128,00 €
52555	134	2,38 €
52558	134	2,38 €
52565	63	11,50 €
52566	140	28,00 €
52567	140	29,00 €
52568	141	28,00 €
52569	141	28,00 €

REF.	PÁGINA	PREÇO
52570	375	2,60 €
52571	375	2,60 €
52572	375	2,60 €
52573	375	2,60 €
52574	152	69,00 €
52575	68, 160	119,00 €
52583	69	8,50 €
52587	50	39,90 €
52588	50	45,00 €
52591	214	12,00 €
52592	214	22,00 €
52593	214	34,00 €
52595	68	64,00 €
52596	67	114,00 €
52597	67	146,00 €
52598	121, 340	1.080,00 €
52599	210	230,00 €
52600	342	884,00 €
52601	304	397,00 €
52603	28	74,00 €
52604	28	78,00 €
52605	28	76,00 €
52606	28	88,00 €
52607	203	49,00 €
52608	203	44,00 €
52609	68	29,00 €
52615	201	112,00 €
52616	296	44,00 €
52617	204	7,00 €
52618	365	29,00 €
52619	59	23,10 €
52620	31	8,80 €
52621	232	11,00 €
52624	241	28,00 €
52625	60, 198	9,00 €
52626	238	46,00 €
52627	238	120,00 €
52628	308	26,50 €
52629	208	99,00 €
52633	359	1,00 €
52634	91	5,25 €
52635	91	4,80 €
52636	194	114,00 €
52637	229	48,00 €
52638	69	9,95 €
52639	209	123,00 €
52640	225	52,00 €
52641	225	55,00 €
52642	228	32,00 €
52643	339	596,00 €
52644	360	8,80 €
52645	371	0,55 €
52646	371	0,50 €
52648	158	9,00 €
52649	370	5,00 €
52650	370	5,00 €
52652	369	2,80 €

REF.	PÁGINA	PREÇO
52653	369	3,00 €
52655	371	39,70 €
52656	371	39,50 €
52657	371	37,50 €
52658	371	39,70 €
52659	371	39,70 €
52660	372	126,00 €
52662	370	36,50 €
52663	370	30,00 €
52664	372	168,00 €
52665	368	0,37 €
52666	368	0,36 €
52667	368	0,76 €
52668	368	1,49 €
52669	368	2,22 €
52670	368	2,95 €
52671	368	3,70 €
52672	368	4,45 €
52673	370	18,00 €
52675	154	84,00 €
52676	154	98,00 €
52677	202	17,00 €
52678	202	18,00 €
52685	210	88,00 €
52687	218	168,00 €
52690	215	54,00 €
52691	232	54,00 €
52692	324	129,00 €
52693	213	24,50 €
52694	168	49,00 €
52696	213	12,00 €
52697	213	16,00 €
52699	228	22,00 €
52700	70	20,50 €
52703	384	22,00 €
52711	383	27,50 €
52714	33	15,70 €
52715	33	10,00 €
52716	33	15,90 €
52717	33	11,00 €
52718	152	48,00 €
52719	389	0,19 €
52722	22	87,00 €
52724	151	381,00 €
52725	151	349,00 €
52727	239	34,60 €
52728	239	68,00 €
52729	239	128,00 €
52730	239	288,00 €
52731	239	38,00 €
52732	239	58,00 €
52733	239	98,00 €
52734	213	51,00 €
52735	166	4,85 €
52736	166	5,35 €
52737	166	5,50 €
52738	375	5,00 €

REF.	PÁGINA	PREÇO
52739	375	5,00 €
52740	184	690,00 €
52749	189	79,00 €
52753	30	107,00 €
52754	204	54,00 €
52757	209	16,00 €
52758	154	88,00 €
52760	70, 216	4,10 €
52761	61	8,00 €
52762	61	9,00 €
52765	185	21,70 €
52768	356	13,80 €
52769	356	14,50 €
52770	356	23,00 €
52771	356	23,40 €
52772	356	13,90 €
52773	356	14,60 €
52774	356	14,80 €
52775	356	15,20 €
52776	356	13,80 €
52777	356	15,50 €
52778	356	14,60 €
52779	356	17,10 €
52780	356	13,90 €
52781	356	14,60 €
52782	356	14,80 €
52783	356	15,20 €
52786	64	14,60 €
52787	157	9,00 €
52788	181	39,00 €
52789	308	15,20 €
52791	58, 59	18,00 €
52794	69	28,00 €
52795	354	5,80 €
52796	228	98,00 €
52797	305	198,00 €
52798	156	18,00 €
52801	212	26,00 €
52802	226	54,00 €
52804	309	343,00 €
52805	309	426,00 €
52806	309	742,00 €
52807	309	1.714,00 €
52809	201	8,50 €
52810	170	9,00 €
52811	170	9,90 €
52812	59	65,00 €
52813	212	79,00 €
52814	149	528,00 €
52815	208	110,00 €
52816	232	28,10 €
52817	232	23,50 €
52819	216	22,00 €
52821	212	28,80 €
52822	230	32,00 €
52823	226	124,00 €
52827	138	46,00 €

REF.	PÁGINA	PREÇO
52828	138	43,00 €
52829	222	19,00 €
52830	64	24,00 €
52831	64	18,00 €
52832	215	75,00 €
52833	237	39,30 €
52834	224	195,00 €
52835	224	272,00 €
52836	184	1.100,00 €
52838	142	56,00 €
52839	142	64,00 €
52842	372	11,00 €
52843	139	31,60 €
52845	323	170,00 €
52846	57	37,80 €
52847	57	41,00 €
52849	230	8,50 €
52850	215	7,80 €
52851	181, 395	9,65 €
52852	230	6,80 €
52858	206	298,00 €
52862	357	1,15 €
52864	357	1,20 €
52865	357	0,50 €
52866	357	0,25 €
52869	100	52,00 €
52870	100	100,00 €
52871	100	258,00 €
52873	69	11,00 €
52874	225	82,00 €
52875	225	79,00 €
52876	180	182,00 €
52877	64	15,80 €
52878	64	11,20 €
52879	64	10,10 €
52880	47	42,00 €
52881	47	17,00 €
52882	213	14,00 €
52884	329	73,00 €
52885	64	18,00 €
52886	396	18,00 €
52887	396	22,00 €
52888	400	24,00 €
52889	398	19,00 €
52890	399	22,00 €
52891	398	28,00 €
52892	399	22,00 €
52893	400	26,00 €
52894	398	22,00 €
52895	400	22,00 €
52896	396	26,00 €
52897	399	38,00 €
52898	399	36,00 €
52899	397	34,00 €
52900	397	34,00 €
52901	397	34,00 €
52902	342	970,00 €

REF.	PÁGINA	PREÇO
52903	342	1.100,00 €
52904	69	61,00 €
52905	70	28,00 €
52906	196	38,00 €
52908	34	17,00 €
52909	34	12,50 €
52910	138	39,00 €
52912	45, 87	91,00 €
52913	51	292,00 €
52914	177	223,00 €
52915	177	199,00 €
52916	177	218,00 €
52917	177	122,00 €
52918	177	146,00 €
52919	177	181,00 €
52920	177	155,00 €
52921	177	117,00 €
52922	177	180,00 €
52923	177	59,00 €
52924	177	52,00 €
52925	177	176,00 €
52926	177	201,00 €
52927	177	59,00 €
52928	177	172,00 €
52929	177	185,00 €
52930	178	117,00 €
52931	178	45,00 €
52932	178	45,00 €
52933	178	194,00 €
52934	178	102,00 €
52935	178	94,00 €
52936	178	199,00 €
52937	178	265,00 €
52938	178	199,00 €
52939	178	28,00 €
52940	178	235,00 €
52941	178	70,00 €
52942	178	105,00 €
52943	178	75,00 €
52944	178	110,00 €
52945	178	281,00 €
52952	331, 344	74,00 €
52953	152	38,00 €
52955	61	19,80 €
52956	61	19,60 €
52957	61	23,80 €
52958	61	28,20 €
52959	61	42,00 €
52960	61	46,00 €
52962	226	42,00 €
52963	217	49,00 €
52964	56	9,45 €
52965	56	9,20 €
52966	56	9,45 €
52967	56	9,40 €
52969	172	20,70 €
52973	42	59,00 €

REF.	PÁGINA	PREÇO
52977	182	137,00 €
52980	335	480,00 €
52982	60, 186	53,00 €
52985	322	598,00 €
52987	132	20,00 €
52991	311	10,50 €
52992	311	18,00 €
52998	185	48,00 €
52999	321	178,00 €
53001	217	242,00 €
53007	357	0,42 €
53008	201	15,50 €
53009	209	42,00 €
53010	54	18,00 €
53017	38	57,00 €
53018	40	119,00 €
53025	69	3,50 €
53026	69	5,80 €
53027	69	9,00 €
53028	331	5,80 €
53029	331	6,80 €
53030	331	12,00 €
53031	100	59,00 €
53032	100	126,00 €
53033	364	21,50 €
53037	371	0,50 €
53038	371	0,50 €
53039	371	0,50 €
53040	371	0,50 €
53041	235	37,60 €
53042	69	9,90 €
53043	175	53,00 €
53044	175	121,00 €
53045	140	35,00 €
53046	140	39,00 €
53047	141	330,00 €
53048	141	89,00 €
53049	140	89,00 €
53051	141	158,00 €
53052	140	158,00 €
53053	215	12,00 €
53054	238	6,00 €
53055	236	33,00 €
53056	241	127,00 €
53057	217	149,00 €
53058	241	193,00 €
53059	242	52,00 €
53060	170	34,90 €
53062	240	99,00 €
53063	162	36,70 €
53064	162	37,40 €
53065	162	36,90 €
53066	162	61,00 €
53067	162	61,00 €
53068	162	63,00 €
53069	208	98,00 €
53070	48	16,20 €

REF.	PÁGINA	PREÇO
53071	48	26,10 €
53072	48	31,60 €
53073	48	50,00 €
53074	17	78,00 €
53077	174	62,00 €
53078	310	18,00 €
53079	189	89,00 €
53080	189	99,00 €
53081	52	115,00 €
53082	52	148,00 €
53083	65	64,00 €
53084	34	24,00 €
53085	135	30,00 €
53086	238	9,00 €
53087	356	11,20 €
53088	356	11,50 €
53089	356	11,50 €
53090	356	11,50 €
53091	356	10,20 €
53092	356	10,20 €
53093	356	10,20 €
53094	356	10,20 €
53095	66	20,50 €
53096	209	28,80 €
53108	22	92,00 €
53110	181, 395	27,30 €
53111	332	19,00 €
53112	314	298,00 €
53118	230	231,00 €
53119	213	52,00 €
53120	65	6,00 €
53121	65	7,35 €
53122	65	9,50 €
53124	188	287,00 €
53125	188	477,00 €
53126	189	243,00 €
53127	34	12,00 €
53129	216	84,00 €
53134	189	144,00 €
53137	155	38,00 €
53140	152	98,00 €
53141	155	68,00 €
53144	307	18,00 €
53145	332	39,20 €
53146	239	30,50 €
53147	163	41,00 €
53150	369	24,00 €
53151	143	14,00 €
53154	36, 345	462,00 €
53156	32	26,20 €
53159	25	289,00 €
53162	332	60,00 €
53164	36, 345	16,50 €
53165	36, 345	19,60 €
53166	339	10,50 €
53167	339	12,50 €
53168	339	19,00 €

REF.	PÁGINA	PREÇO
53177	356	11,90 €
53178	356	12,20 €
53179	356	12,20 €
53180	356	12,20 €
53181	356	11,90 €
53182	356	12,20 €
53183	356	12,70 €
53184	356	12,20 €
53185	355	13,20 €
53186	355	13,20 €
53187	311	39,00 €
53188	311	7,00 €
53189	337	128,00 €
53190	337	98,00 €
53191	98	14,80 €
53192	98	52,00 €
53196	192	33,00 €
53197	174	46,00 €
53198	311	9,50 €
53200	318	69,00 €
53202	160	15,70 €
53203	357	0,46 €
53204	160	81,00 €
53205	157	19,00 €
53206	202	38,20 €
53207	225	118,00 €
53208	225	126,00 €
53209	329	8,50 €
53210	48	48,00 €
53211	99	75,00 €
53212	16	174,00 €
53214	309	285,00 €
53215	307	19,00 €
53216	130	49,00 €
53217	132	47,00 €
53218	318	26,00 €
53220	334	260,00 €
53221	365	4,75 €
53224	180	142,00 €
53225	56	3,50 €
53226	192	14,90 €
53227	135	28,00 €
53229	388	38,70 €
53230	183	19,70 €
53232	185	39,00 €
53235	203	10,40 €
53236	203	11,50 €
53237	203	12,90 €
53238	203	18,40 €
53240	234	58,00 €
53241	361	9,00 €
53246	324	1.144,00 €
53249	231	192,00 €
53250	208	85,00 €
53251	213	88,00 €
53253	96	98,00 €
53256	368	34,00 €

REF.	PÁGINA	PREÇO
53259	249	97,00 €
53260	249	168,00 €
53261	249	214,00 €
53262	250	251,00 €
53263	250	57,00 €
53264	250	143,00 €
53265	251	195,00 €
53266	251	224,00 €
53267	251	277,00 €
53268	258	92,00 €
53269	252	50,00 €
53270	270	70,00 €
53271	270	227,00 €
53272	271	195,00 €
53273	271	75,00 €
53274	284	30,50 €
53275	284	35,50 €
53276	285	160,00 €
53277	285	45,00 €
53278	285	143,00 €
53279	286	97,00 €
53280	286	112,00 €
53281	286	55,00 €
53282	287	48,00 €
53283	287	92,00 €
53284	287	306,00 €
53285	288	56,00 €
53286	288	87,00 €
53287	288	245,00 €
53288	289	72,00 €
53289	274	45,00 €
53290	274	51,00 €
53291	274	68,00 €
53292	275	116,00 €
53293	261	134,00 €
53294	261	119,00 €
53295	262	77,00 €
53296	262	60,00 €
53297	267	45,00 €
53298	267	91,00 €
53299	278	291,00 €
53300	278	41,00 €
53301	278	44,00 €
53302	279	44,00 €
53303	244	89,00 €
53304	244	279,00 €
53305	279	136,00 €
53306	244	53,00 €
53307	279	38,50 €
53308	245	55,00 €
53309	245	285,00 €
53310	245	498,00 €
53311	275	97,00 €
53312	246	127,00 €
53313	258	139,00 €
53314	258	98,00 €
53315	295	285,00 €

REF.	PÁGINA	PREÇO
53316	280	34,00 €
53317	280	34,00 €
53318	261	24,00 €
53319	246	18,00 €
53320	289	12,00 €
53321	289	10,50 €
53324	264	12,50 €
53325	289	7,50 €
53326	290	16,00 €
53327	290	11,00 €
53328	226	76,00 €
53330	212	38,00 €
53331	67	31,80 €
53332	67	34,50 €
53339	70	9,50 €
53340	388	86,00 €
53343	149	285,00 €
53346	50	18,00 €
53347	205	100,00 €
53348	382	14,00 €
53349	392	14,00 €
53350	382	14,00 €
53351	384	12,50 €
53352	390	12,00 €
53353	387	18,00 €
53354	384	14,00 €
53355	393	11,50 €
53356	393	11,50 €
53357	394	7,00 €
53358	390	11,50 €
53359	390	16,00 €
53360	384	18,00 €
53361	384	24,00 €
53362	385	14,00 €
53363	382	34,00 €
53364	382	16,00 €
53365	385	14,00 €
53366	385	14,00 €
53367	393	9,50 €
53368	393	9,00 €
53369	385	14,00 €
53370	393	26,00 €
53371	383	29,00 €
53372	383	26,00 €
53373	383	14,50 €
53374	392	10,00 €
53376	392	10,50 €
53377	386	20,00 €
53378	390	13,00 €
53380	393	11,50 €
53381	390	14,50 €
53382	383	11,00 €
53383	383	11,50 €
53384	225	165,00 €
53385	61, 394	19,30 €
53388	233	90,00 €
53389	57	31,50 €

REF.	PÁGINA	PREÇO
53390	58	34,50 €
53391	234	86,00 €
53393	234	118,00 €
53394	223	598,00 €
53395	218	16,00 €
53396	58	18,30 €
53399	92	3,50 €
53400	92	5,70 €
53401	92	7,40 €
53402	92	9,60 €
53403	92	6,50 €
53404	92	6,50 €
53405	92	5,30 €
53406	92	8,55 €
53407	92	12,70 €
53408	92	19,30 €
53409	92	9,00 €
53410	217	92,00 €
53411	60	5,00 €
53412	60	4,00 €
53414	333	49,00 €
53415	333	188,00 €
53416	158	14,10 €
53417	158	26,30 €
53418	158	16,90 €
53419	372	9,70 €
53420	44	72,00 €
53421	315	298,00 €
53422	314	368,00 €
53423	323	199,00 €
53426	217	39,80 €
53427	134	5,00 €
53428	139	18,00 €
53429	139	18,00 €
53430	178	286,00 €
53434	392	18,00 €
53441	201	9,80 €
53444	27	195,00 €
53445	60	17,10 €
53449	158	16,40 €
53450	158	28,30 €
53452	280	26,50 €
53453	218	7,00 €
53456	220	98,00 €
53459	221	66,00 €
53463	242	98,00 €
53464	209, 387	153,00 €
53468	52	8,50 €
53470	171	176,00 €
53472	204	12,00 €
53473	204	36,00 €
53474	234	94,00 €
53477	217	36,10 €
53478	52	4,55 €
53479	52	6,40 €
53480	52	19,90 €
53481	52	27,40 €

REF.	PÁGINA	PREÇO
53484	332	615,00 €
53485	205	140,00 €
53486	183	29,30 €
53487	59	16,70 €
53488	229	61,00 €
53489	211	68,00 €
53490	209	275,00 €
53492	163, 410	380,00 €
53499	220	29,00 €
53500	220	29,00 €
53501	209	24,00 €
53502	236	38,70 €
53503	338	12,00 €
53504	410	38,00 €
53505	135	77,00 €
53506	135	36,00 €
53507	354	27,00 €
53508	365	14,00 €
53517	64	9,50 €
53518	310	3,50 €
53519	130	42,00 €
53520	146	228,00 €
53522	209	24,00 €
53523	275	91,00 €
53524	237	51,00 €
53525	182	12,00 €
53526	338, 348	119,00 €
53531	169	109,00 €
53532	164, 348	119,00 €
53533	409	1,50 €
53536	143	34,00 €
53537	204	14,50 €
53538	204	14,50 €
53539	219	66,00 €
53541	152	168,00 €
53542	159, 372	980,00 €
53543	337	13,80 €
53545	180	35,70 €
53547	56	14,70 €
53548	56	15,60 €
53549	56	14,30 €
53550	56	14,70 €
53551	374	16,00 €
53552	374	16,00 €
53553	374	16,00 €
53561	365	28,00 €
53565	24	258,00 €
53566	304	32,00 €
53567	161	43,00 €
53568	133	12,00 €
53569	133	18,00 €
53570	136	154,00 €
53572	161	348,00 €
53573	151	36,00 €
53574	31	47,00 €
53575	55	16,00 €
53576	153	189,00 €

REF.	PÁGINA	PREÇO
53581	164, 348	119,00 €
53582	164, 348	174,00 €
53583	164, 348	174,00 €
53584	338, 348	119,00 €
53585	338, 348	168,00 €
53586	338, 348	168,00 €
53587	173	44,00 €
53588	146	178,00 €
53589	70	12,00 €
53590	321	1.190,00 €
53591	64	5,50 €
53592	312	25,00 €
53593	160	41,00 €
53594	163	54,00 €
53595	163	61,00 €
53596	376	3,65 €
53597	376	3,70 €
53598	376	3,95 €
53599	221, 389	30,30 €
53602	61	30,50 €
53603	61	45,00 €
53604	61	118,00 €
53605	372	141,00 €
53606	158	55,00 €
53608	148	98,00 €
53609	302	182,50 €
53610	302	294,00 €
53611	156	27,50 €
53612	310	96,00 €
53613	68	19,50 €
53614	68	21,50 €
53615	68	34,60 €
53616	68	10,40 €
53617	68	9,25 €
53618	68	13,90 €
53620	89	88,00 €
53621	355	2,50 €
53622	355	2,50 €
53623	355	2,50 €
53624	355	2,50 €
53625	160	68,00 €
53626	154, 184	18,00 €
53627	305	22,50 €
53629	164	14,30 €
53630	164	18,80 €
53631	164	33,50 €
53632	164	46,00 €
53633	164	46,00 €
53634	164	63,00 €
53635	225	85,00 €
53636	354	22,00 €
53637	215	85,00 €
53638	222	243,00 €
53639	47	28,60 €
53640	47	34,40 €
53641	47	41,00 €
53642	47	54,00 €

REF.	PÁGINA	PREÇO
53643	47	92,00 €
53644	303	1.238,00 €
53645	303	268,00 €
53646	153	69,00 €
53648	290	107,00 €
53649	291	89,00 €
53650	212	47,00 €
53651	280	91,00 €
53652	237	53,00 €
53653	264	207,00 €
53654	47	81,00 €
53655	182	12,00 €
53656	334	198,00 €
53657	334	248,00 €
53658	334	99,00 €
53659	334	121,00 €
53660	334	146,00 €
53661	77	790,00 €
53662	214	89,00 €
53663	235	8,00 €
53664	238	38,00 €
53665	238	19,00 €
53666	238	28,00 €
53667	35	32,00 €
53668	35	34,00 €
53669	215	45,00 €
53670	202	29,50 €
53671	51, 89	41,00 €
53672	82	440,00 €
53673	183	80,00 €
53674	94	447,00 €
53675	186	50,00 €
53676	186	44,00 €
53677	186	55,00 €
53678	186	52,00 €
53681	149	743,00 €
53682	322	98,00 €
53683	196	116,00 €
53684	321	1.880,00 €
53685	189	310,00 €
53686	77	790,00 €
53687	328	298,00 €
53688	328	495,00 €
53689	147	238,00 €
53690	137	34,00 €
53691	137	36,00 €
53693	360	521,00 €
53694	54	18,40 €
53695	360	504,00 €
53696	209	22,00 €
53697	302	398,00 €
53698	360	717,00 €
53701	240	188,00 €
53702	97	28,50 €
53703	97	41,00 €
53704	97	42,00 €
53705	191	80,00 €

REF.	PÁGINA	PREÇO
53706	291	98,00 €
53707	136	153,00 €
53708	74, 76, 77, 83	325,00 €
53710	404	16,00 €
53711	404	16,00 €
53712	403	16,00 €
53713	403	16,00 €
53714	403	16,00 €
53715	402	19,00 €
53716	402	19,00 €
53717	402	19,00 €
53718	401	19,00 €
53719	401	19,00 €
53720	401	19,00 €
53721	355	18,80 €
53724	332	46,00 €
53725	314	248,00 €
53726	148	128,00 €
53727	23	198,00 €
53728	23	198,00 €
53729	184	19,10 €
53733	147	238,00 €
53734	130	23,70 €
53735	203	44,00 €
53736	189	98,00 €
53737	45	12,50 €
53738	45	10,90 €
53739	45	10,50 €
53740	45	9,10 €
53741	204	14,00 €
53742	223	1.325,00 €
53743	32, 175	39,70 €
53744	170	63,00 €
53745	362	6,40 €
53746	362	6,40 €
53747	362	6,40 €
53748	362	6,60 €
53749	362	6,70 €
53750	362	6,70 €
53751	362	6,80 €
53752	362	6,95 €
53753	362	7,10 €
53754	362	7,40 €
53755	362	7,50 €
53756	362	7,90 €
53757	362	7,90 €
53758	362	8,20 €
53759	362	8,50 €
53760	362	9,60 €
53761	77	490,00 €
53762	77	490,00 €
53767	77	790,00 €
53768	77	490,00 €
53769	80, 297, 300	178,00 €
53770	80, 298, 300	198,00 €
53771	80, 299, 300	158,00 €

REF.	PÁGINA	PREÇO
53772	80, 299, 300	229,00 €
53773	80, 297, 300	298,00 €
53774	80, 298, 300	190,00 €
53775	80, 300	1.109,00 €
53776	131	19,10 €
53778	354	4,50 €
53779	318	36,00 €
53780	132	14,50 €
53781	377	18,00 €
53782	96	14,00 €
53784	150	148,00 €
53785	376	4,80 €
53786	380	98,00 €
53791	378	4,80 €
53794	376	28,00 €
53796	380	76,00 €
53797	377	0,10 €
53802	380	120,00 €
53806	380	250,00 €
53808	379	16,50 €
53809	379	8,00 €
53811	379	8,90 €
53826	378	16,00 €
53827	378	32,00 €
53832	378	1,81 €
53838	380	38,00 €
53839	379	0,25 €
53845	318	64,00 €
53849	312	16,10 €
53850	123	14,90 €
53851	125	88,00 €
53852	125	207,00 €
53853	125	14,40 €
53854	125	27,00 €
53855	125	24,80 €
53856	125	62,00 €
53857	126	27,00 €
53858	126	28,80 €
53859	124	67,00 €
53860	124	3,65 €
53861	124	5,45 €
53862	377	6,00 €
53863	377	3,00 €
53864	369	138,00 €
53867	82	1.095,00 €
53868	74	1.090,00 €
53869	75	990,00 €
53870	75	990,00 €
53872	348	118,00 €
53873	307	285,00 €
53874	307	398,00 €
53875	216	134,00 €
53876	259	64,00 €
53877	411	430,50 €
53878	411	574,00 €
53879	411	838,50 €

REF.	PÁGINA	PREÇO
53880	320	598,00 €
53881	164, 348	79,00 €
53882	164, 348	79,00 €
53883	50	18,40 €
53884	50	30,20 €
53885	50	35,70 €
53886	50	20,30 €
53887	50	30,30 €
53888	50	37,90 €
53895	317	107,00 €
53896	317	127,00 €
53897	317	140,00 €
53898	317	148,00 €
53902	378	25,00 €
53903	97	59,00 €
53904	77	790,00 €
53905	56	7,30 €
53906	56	8,65 €
53908	56	7,25 €
53909	56	9,70 €
53910	392	19,00 €
53911	57	8,80 €
53912	75	1.280,00 €
53913	75	1.280,00 €
53914	379, 412	75,00 €
53915	22	65,00 €
53917	54	9,00 €
53919	363	81,00 €
53921	190	39,00 €
53922	190	29,00 €
53927	329	66,00 €
53928	26	278,00 €
53929	329	95,00 €
53932	61	8,00 €
53939	74	1.280,00 €
53940	79, 344, 346, 379	13,20 €
53942	79, 344, 346, 379	0,50 €
53943	54, 86	21,50 €
53944	54, 86	19,50 €
53945	54, 86	18,90 €
53946	377	0,83 €
53947	336	145,00 €
53948	336	324,00 €
53949	409	4,50 €
53950	409	4,50 €
53951	80, 300	1.794,00 €
53952	80, 300	1.794,00 €
53953	20	29,00 €
53954	45	8,50 €
53955	45	10,00 €
53956	408	353,00 €
53957	377	0,26 €
53958	98	6,50 €
53964	364	9,65 €
53965	364	25,80 €
53967	57	10,20 €

REF.	PÁGINA	PREÇO
53968	314	49,00 €
53969	323	96,00 €
53970	343	3.790,00 €
53972	52	550,00 €
53973	408	284,00 €
53974	134	38,00 €
53976	61	9,00 €
53977	332	17,50 €
53978	195	38,90 €
53979	45, 88	34,60 €
53980	45, 88	34,60 €
53981	333	143,00 €
53982	333	219,00 €
53983	188	215,00 €
53984	374	8,00 €
53985	374	8,00 €
53986	374	8,00 €
53987	344, 379	9,50 €
53988	173	101,00 €
53992	392	18,00 €
53993	66	77,00 €
53997	211	48,00 €
53999	127	2,00 €
54000	127	2,50 €
54001	317	285,00 €
54002	127	3,00 €
54003	238	104,00 €
54004	133	16,00 €
54005	46	14,00 €
54006	77	490,00 €
54008	127	3,50 €
54010	127	4,50 €
54011	127	5,00 €
54013	369	35,00 €
54015	57	10,20 €
54016	211	76,00 €
54017	182	12,00 €
54018	49	9,85 €
54019	49	17,90 €
54021	49	13,50 €
54022	49	9,95 €
54023	49	13,50 €
54024	49	17,90 €
54028	49	28,00 €
54029	49	28,00 €
54030	49	18,80 €
54031	49	19,30 €
54032	39, 88	84,00 €
54033	161	49,00 €
54034	9	178,00 €
54035	12	149,00 €
54036	13	99,00 €
54037	14	88,00 €
54038	15	88,00 €
54039	135	154,00 €
54040	330	240,00 €
54041	40	198,00 €

REF.	PÁGINA	PREÇO
54042	358	13,00 €
54043	408	48,00 €
54044	143	99,00 €
54045	9	179,00 €
54046	12	150,00 €
54047	13	100,00 €
54048	14	89,00 €
54049	15	89,00 €
54050	306	895,00 €
54051	308	39,00 €
54053	342	248,00 €
54054	342	268,00 €
54055	342	220,00 €
54056	342	260,00 €
54057	342	248,00 €
54058	342	348,00 €
54059	343	428,00 €
54060	55	6,00 €
54061	55	6,00 €
54066	39, 87	83,00 €
54068	200	120,00 €
54069	221	29,50 €
54070	55	18,00 €
54071	55	26,50 €
54072	358	38,50 €
54073	363	70,00 €
54074	363	18,50 €
54076	409	9,00 €
54078	144	68,00 €
54079	41	83,00 €
54080	96	53,50 €
54081	43	28,00 €
54082	11	189,00 €
54083	49	9,75 €
54084	49	13,10 €
54085	49	17,80 €
54086	49	9,25 €
54087	49	17,30 €
54088	135	132,00 €
54089	65	17,50 €
54090	21	56,00 €
54091	35, 345	441,00 €
54092	291	24,00 €
54093	35, 79, 87, 345, 346	441,00 €
54097	41	38,90 €
54098	47	158,50 €
54099	66	13,80 €
54100	302	265,00 €
54101	38	61,00 €
54105	21	33,00 €
54106	17, 46	89,00 €
54108	18	66,00 €
54109	20	34,00 €
54110	40	46,00 €
54111	333	4,75 €
54112	62	18,00 €
54113	333	7,65 €

REF.	PÁGINA	PREÇO
54114	79, 330, 346	248,00 €
54115	43	26,80 €
54116	18	66,00 €
54117	38	74,00 €
54119	44	78,00 €
54120	41	59,00 €
54122	131	38,00 €
54123	131	40,00 €
54124	131	47,00 €
54125	337	152,00 €
54126	54	39,00 €
54129	79, 346	110,00 €
54130	79, 345, 346	58,00 €
54131	345	58,00 €
54132	79, 346	190,00 €
54133	135	547,00 €
54134	78, 84	1.415,00 €
54135	197	82,00 €
54136	372	107,00 €
54137	315	288,00 €
54139	218	147,00 €
54140	17	36,00 €
54141	22	42,00 €
54142	62	15,20 €
54143	318	249,00 €
54144	318	298,00 €
54145	318	377,00 €
54146	318	492,00 €
54147	318	198,00 €
54149	42	60,00 €
54150	42	23,50 €
54151	374	9,00 €
54152	374	9,00 €
54153	374	9,00 €
54154	29	37,50 €
54155	374	8,00 €
54156	374	8,00 €
54157	374	8,00 €
54158	86	38,00 €
54159	43	47,00 €
54160L	143	17,50 €
54160R	143	17,50 €
54161	142	90,00 €
54162	142	81,00 €
54163	142	80,00 €
54164	29	34,00 €
54166	363	32,40 €
54168	20	49,00 €
54169	363	13,80 €
54170	363	16,50 €
54172	137	81,00 €
54173	137	87,00 €
54174	41	139,00 €
54175	326	34,00 €
54176	350	188,00 €
54177	374	16,00 €

REF.	PÁGINA	PREÇO
54178	374	16,00 €
54179	374	16,00 €
54181	310	25,10 €
54182	310	34,70 €
54183	310	38,20 €
54184	310	44,00 €
54186	206	250,00 €
54187	46	39,30 €
54188	376	19,00 €
54189	376	19,00 €
54190	376	19,00 €
54191	376	19,00 €
54192	375	8,90 €
54193	375	8,90 €
54194	375	8,90 €
54195	375	8,90 €
54198	372	59,00 €
54199	292	94,00 €
54200	296	56,00 €
54201	264	37,60 €
54202	246	68,00 €
54203	247	91,00 €
54204	265	124,00 €
54205	281	49,00 €
54206	252	113,00 €
54207	270	38,90 €
54208	265	76,00 €
54209	265	29,70 €
54210	276	84,00 €
54211	247	74,00 €
54212	247	39,40 €
54213	260	19,80 €
54214	281	96,00 €
54215	248	57,00 €
54216	248	49,00 €
54217	281	104,00 €
54218	292	142,00 €
54219	253	60,00 €
54220	208	197,00 €
54221	282	111,00 €
54222	253	59,00 €
54223	266	149,00 €
54224	266	64,50 €
54225	276	133,00 €
54226	295	71,00 €
54227	253	122,00 €
54228	254	187,00 €
54229	337	48,00 €
54230	337	68,00 €
54231	337	138,00 €
54232	337	248,00 €
54233	79, 346	1.856,00 €
54234	79, 346	1.856,00 €
54235	79, 346	1.856,00 €
54236	79, 346	1.856,00 €
54237	78	1.887,00 €
54238	78	1.887,00 €

REF.	PÁGINA	PREÇO
54239	78	1.887,00 €
54240	78	1.887,00 €
54241	79, 346	120,00 €
54246	182	104,00 €
54247	182	99,00 €
54248	158	58,00 €
54249	158	103,00 €
54250	10	188,00 €
54251	157	43,00 €
54252	340	199,00 €
54253	227	166,00 €
54254	62	43,00 €
54255	156, 312	68,00 €
54256	330	48,00 €
54257	319	318,00 €
54258	19	58,00 €
54260	266	277,00 €
54261	24	321,00 €
54262	323	88,00 €
54263	323	130,00 €
54264	323	240,00 €
54265	343	1.290,00 €
54266	29	39,50 €
54267	133	9,50 €
54269	51	56,00 €
54270	136	42,00 €
54271	136	54,00 €
54273	214	10,10 €
54274	214	11,00 €
54275	214	13,20 €
54277	19	53,50 €
54278	409	4,50 €
54279	58	6,00 €
54280	237	156,50 €
54288	259	72,50 €
54289	277	38,00 €
54290	306	4.307,00 €
54291	220	5.054,00 €
54293	254	17,50 €
54294	374	8,00 €
54295	81	500,00 €
54296	81	520,00 €
54297	81	540,00 €
54298	354	7,50 €
54299	227	227,00 €
54302	53	11,50 €
54304	50	26,00 €
54305	351	232,50 €
54306	352	219,50 €
54308	352	89,00 €
54309	352	71,00 €
54310	352	57,00 €
54311	58	13,00 €
54312	210	191,50 €
54313	126	43,00 €
54314	126	82,00 €
54316	172	182,00 €

REF.	PÁGINA	PREÇO
54317	226	124,00 €
54318	271	105,00 €
54321	343	898,00 €
54322	344, 379	19,00 €
54323	259	119,00 €
54324	257	11,00 €
54325	409	22,50 €
54326	79, 344, 346, 379	7,30 €
54327	72	2.788,00 €
54328	94	199,00 €
54329	371	37,50 €
54330	58	12,50 €
54331	65	27,00 €
54336	150	259,00 €
54338	39	60,00 €
54339	51	273,00 €
54340	147	296,00 €
54341	335	643,00 €
54342	335	858,00 €
54343	53	31,00 €
54344	132	10,50 €
54345	206	15,00 €
54346	127	11,50 €
54347	214	46,00 €
54348	126	291,00 €
54349	325	8,00 €
54350	325	12,50 €
54351	325	14,00 €
54352	325	18,00 €
54353	325	23,50 €
54354	325	34,50 €
54355	325	12,00 €
54356	326	19,50 €
54357	325	15,00 €
54358	325	18,50 €
54359	326	14,00 €
54360	325	14,00 €
54361	325	14,00 €
54362	326	14,00 €
54363	325	14,00 €
54364	326	14,00 €
54365	325	12,50 €
54366	326	18,50 €
54367	306	729,00 €
54368	219	2.329,00 €
54369	374	16,00 €
54370	374	16,00 €
54371	374	16,00 €
54372	198	157,00 €
54373	210	395,00 €
54374	96	75,50 €
54376	58	12,00 €
54379	131	28,00 €
54380	233	119,00 €
54381	233	5,00 €
54382	233	5,00 €
54383	233	5,00 €

REF.	PÁGINA	PREÇO
54384	222	32,50 €
54386	324, 346	5.839,00 €
54388	93	366,00 €
54389	76	790,00 €
54390	389	199,00 €
54391	207	221,00 €
54392	207	1.855,00 €
54393	95	92,00 €
54394	95	64,00 €
54395	95	53,00 €
54396	320	2.250,00 €
54397	147	249,00 €
54398	254	41,00 €
54399	255	56,50 €
54400	255	141,00 €
54401	255	57,00 €
54402	256	201,00 €
54403	256	225,00 €
54404	256	131,00 €
54405	257	111,00 €
54406	257	73,00 €
54407	292	59,50 €
54408	293	46,00 €
54409	293	32,00 €
54410	293	33,50 €
54411	294	36,00 €
54412	294	57,00 €
54413	294	115,00 €
54414	272	97,50 €
54415	272	60,00 €
54416	272	31,00 €
54417	273	153,00 €
54418	273	37,00 €
54419	262	57,00 €
54420	263	102,00 €
54421	263	52,00 €

REF.	PÁGINA	PREÇO
54422	267	140,00 €
54423	268	108,00 €
54424	263	64,50 €
54425	268	124,00 €
54426	268	69,00 €
54427	269	113,00 €
54428	269	31,00 €
54429	269	55,00 €
54430	248	34,00 €
54431	295	184,00 €
54432	260	43,00 €
54433	260	18,00 €
54434	282	48,50 €
54435	282	14,50 €
54436	283	124,00 €
54437	283	110,00 €
54438	277	40,00 €
54439	277	32,50 €
54479	59	36,50 €
54480	409	1,00 €
54482	334	677,00 €
54483	325	14,00 €
54484	325	26,00 €
54485	325	36,00 €
54486	325	9,50 €
54487	326	15,00 €
54488	325	15,00 €
54489	326	19,50 €
54490	326	15,00 €
54491	326	17,50 €
54492	326	19,50 €
54493	325	13,50 €
54494	325	14,00 €
54495	326	18,00 €
54496	326	16,50 €
54497	326	12,50 €

REF.	PÁGINA	PREÇO
54498	309	6.090,00 €
54501	80, 300	1.794,00 €
54502	80, 300	1.794,00 €
54503	76	490,00 €
54534	355	24,00 €
60001	116	88,00 €
60003	116	110,00 €
60004	117	79,00 €
60005	105	132,00 €
60006	106	182,00 €
60007	111	170,00 €
60009	108	168,00 €
60010	111	170,00 €
60011	112	175,00 €
60012	122	48,00 €
60013	122	80,00 €
60015	122	138,00 €
60016	122	49,00 €
60017	122	64,00 €
60019	110	178,00 €
60020	110	175,00 €
60022	112	470,00 €
60023	106	212,00 €
60024	105	190,00 €
60025	105, 122	31,60 €
60026	105, 122	379,00 €
60027	118	99,00 €
60028	109	142,00 €
60029	119	240,00 €
60030	119	112,00 €
60031	120	142,00 €
60032	113	123,00 €
60033	108	104,00 €
60035	117	30,00 €
60037	114	222,00 €
60038	113, 312	255,00 €

REF.	PÁGINA	PREÇO
60039	118	265,00 €
60040	120	440,00 €
60041	114	77,00 €
60042	115	106,00 €
60043	115	123,00 €
60044	103	330,00 €
60044C	103	485,00 €
60045	121	298,00 €
60046	102	174,00 €
60046C	102	339,00 €
60047C	107	318,00 €
60048	104	366,00 €
60048C	104	560,00 €
60049C	109	329,00 €
70001	406	35,00 €
70002	406	35,00 €
70003	406	35,00 €
70004	406	42,00 €
70005	406	42,00 €
70006	406	42,00 €
70009	406	35,00 €
70011	406	42,00 €
70012	406	42,00 €
70013	406	44,00 €
70014	406	44,00 €
70015	406	44,00 €
70016	406	44,00 €
70017	406	44,00 €
90003	160	35,20 €
90004	160	25,80 €
JBMW-BEXP	362	24,50 €
METEXP	361, 406, 410	62,00 €
SERIE124	360	710,00 €
SERIE262	154, 184	199,00 €





www.jbmcamp.com



JBMprofessionaltools



@jbmtools



jbmtools



JBM Campllong S.L.U.



CAT2024PT



8 435034 988857