



JONNESWAY®

Ferramentas Profissionais Manuais e Pneumáticas



2024

**De Profissionais
Para Profissionais**



Ferramentas Profissionais Manuais e Pneumáticas



Este catálogo anula e substitui todas as edições anteriores.
Todos os preços apresentados nesta tabela estão sujeitos a IVA à taxa legal em vigor.

A Jonnesway está em constante desenvolvimento dos seus produtos, portanto, os modelos, composições, características técnicas, físicas, design e preços podem ser alterados, substituídos ou mesmo retirados deste catálogo sem aviso prévio e sem obrigação de efetuar qualquer alteração nas ferramentas e/ou equipamentos vendidos anteriormente. As capacidades indicadas para os produtos, são as que resultaram dos ensaios realizados nos laboratórios da Jonnesway, não sendo portanto contratuais.

















 www.jonneswaytools.com

 facebook.com/jonneswaytools



Lusilectra
Salvador Caetano

Catálogo versão 3.7
Entra em vigor em janeiro de 2024

Carros e Composições de Ferramentas	Composições de ferramentas	7-18	
	Carros para ferramentas	19-20	
	Caixas, tornos e complementos para carros	21-23	
Ferramenta Manual	Tabuleiros de ferramenta	26-41	
	Ferramenta de aperto	42-87	
	Alicates	88-96	
	Chaves	97-111	
	Martelos, punções e escopros	112-114	
	Corte, desbaste e medida	115-116	
	Ferramenta isolada a 1 000V	117-121	
	Ferramenta Especial Mecânica	Mecânica	124-160
Motociclos		161-162	
Chapeiro		162-167	
Pesados		167-168	
Ferramenta Pneumática	Ferramenta pneumática	170-188	
	Acessórios para redes de ar comprimido	189-191	
Merchandising	Merchandising	194-197	
Outros Equipamentos	Outros equipamentos	200-203	



JONNESWAY®

Ferramentas Profissionais

• Manuais • Pneumáticas •
específicas para automóvel, motociclos e pesados





JONNESWAY®

Carros e Composições de Ferramentas



**Composições
de ferramentas**

**Caixas, tornos e
complementos
para carros**



**Carros para
ferramentas**



JONNESWAY®

Painéis de Ferramentas em Espuma

- Painel vertical
- Optimização de espaços
- Personalização
- Organização de ferramentas
- Produtividade



(Imagem ilustrativa - painel não inclui a ferramenta)

Painel de ferramentas personalizável em espuma para aplicação na vertical.

Estes painéis totalmente personalizáveis tanto nas medidas/ dimensões do painel, como também nas composições de ferramenta que cada painel deverá conter.

Preço para painel com outras medidas e composições - SOB CONSULTA

EVA POWER

Composição de ferramentas profissionais em tabuleiros EVA

TABULEIROS

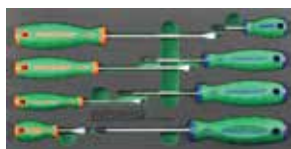

D71PP08KV

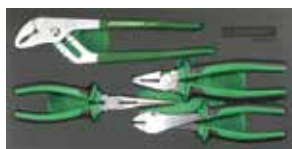

P011804KV



S04H4144KV



H10MT08KV



P32M105KV



S29H4141KV

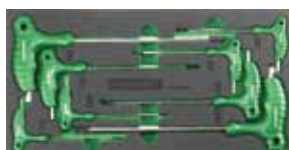

H10MB08KV



MHS08KV



M09103KV



S03A4122KV



W25110KV



S04H2132KV



W26116KV



M63113KV

Composição: 218 peças

- S04H4144KV Jogo de chaves de caixa com roquete de 1/2" e 1/4" - 44 peças
- S04H2132KV Jogo de chaves de vela, extensões e bits - 32 peças
- W26116KV Jogo de chaves mistas - 16 peças
- S03A4122KV Jogo de chaves de impacto de 1/2" - 22 peças
- M63113KV Jogo de punções, saca troços e talhadeiras - 13 peças
- W25110KV Jogo de chaves de bocas - 10 peças
- P011804KV Jogo de alicates - 4 peças

- S29H4141KV Jogo com chave de travões e bits - 41 peças
- H10MB08KV Jogo de chaves hexagonais de punho - 8 peças
- H10MT08KV Jogo de chaves torx de punho - 8 peças
- M09103KV Jogo de martelos - 3 peças
- P32M105KV Jogo de alicates de freios - 5 peças
- MHS08KV Jogo com serra, régua, x-ato e fita métrica

CARROS



C-6DWB1



C-7DC2B



EVA POWER-V	Cor: verde		2 204.00€
EVA POWER-C	Cor: cinza		2 204.00€

EVA POWER BLACK	Cor: preto		1 944.00€
------------------------	------------	---	-----------

MEC SOLUTION

Composição de ferramentas profissionais, ajustável às suas necessidades

Adicione **3 TABULEIROS EVA**, sendo **1 do TIPO A** e **2 do TIPO B** e finalmente escolha o carro que vá de encontro das suas necessidades

TABULEIROS TIPO

A



S04H42165SV

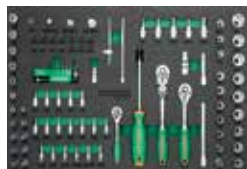

S04H31945SV



S04H21845SV



S04H42955SV



S04H461215SV

TABULEIROS TIPO

B



W26234315V



D7371285V



H101215V



D7371345V



P827365V



P827145V



W235595V



D711575V



W261345V

CARROS

CARRO



C-6DWB1



C-7DC2B



MEC SOLUTION-V Cor: verde 1 740.00€

MEC SOLUTION-C Cor: cinza 1 740.00€

MEC SOLUTION BLACK Cor: preto 1 610.00€

MEC POWER

Composição de ferramentas profissionais, em tabuleiros rígidos de polipropileno

TABULEIROS

Composição: 198 peças

- | | |
|------------|--|
| AG010002SP | Jogo 4 alicates de freios |
| P018SP1 | Jogo 3 alicates (universal/ pontas/ corte) |
| AG010026SP | Jogo 2 martelos e cinzeis |
| D71PP08SP | Jogo 8 chaves fenda/ philips |
| H01SM109S | Jogo 9 chaves macho hexagonal |
| H10MT08SP | Jogo 8 chaves torx dupla punho |
| M645114SP | Jogo serra, punções e chave inglesa |
| P2710SP | Jogo alicate pressão e alicate ajustável |

- | | |
|------------|------------------------------------|
| S04H2125SP | Jogo chaves caixa com roquete 1/4" |
| S04H4125SP | Jogo chaves caixa com roquete 1/2" |
| S06H427SP | Jogo bits caixa 1/2" e 3/8" |
| S29H4140SP | Jogo bits 1/2" e 3/8" |
| W25110SP | Jogo 10 chaves de bocas |
| W26116SP | Jogo 16 chaves mistas |
| W23108SP | Jogo 8 chaves luneta 75° |

CARROS

C-6DWB1



C-7DC2B

MEC POWER 19V	Cor: verde 	1 903.00€
MEC POWER 19C	Cor: cinza 	1 903.00€

BLACK POWER 19	Cor: preto 	1 644.00€
-----------------------	--	-----------



MEC POLEGADAS Composição de ferramenta de polegada

TABULEIROS



Composição: 114 peças
Tabuleiro com
 Jogo 17 chaves hexagonais longas 1/16" a 3/4"
 Jogo 14 chaves caixa de impacto longas 3/8" a 1-1/4"
 Chave inglesa
 Reparador de roscas

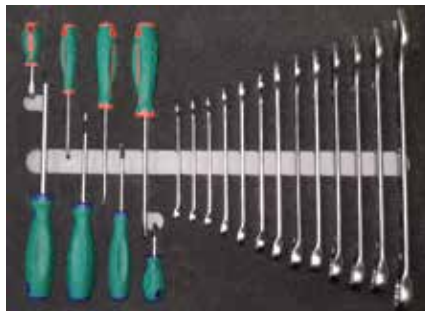

Tabuleiro com
 Jogo de 8 chaves fenda/ phillips
 Jogo de 14 chaves mistas boca/ luneta 3/8" a 1-1/4"

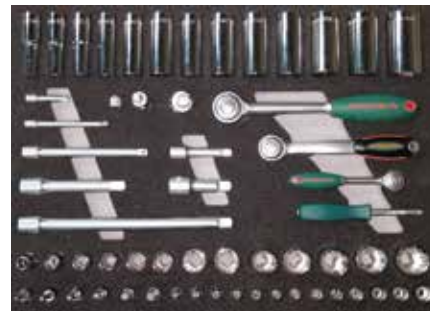

Tabuleiro com
 Jogo de 13 chaves de caixa 1/2 longas 7/16" a 1-1/4"
 Jogo de 13 chaves de caixa 1/2 de 7/16" a 1-1/8"
 Jogo de 6 bits hexagonais 3/8" 5/32"; 3/16"; 7/32"; 1/4"; 5/16" e 3/8"
 Jogo 13 chaves de caixa 1/4" SUPERTECH 5/32" a 9/16"
 3 Roquetes 1/4"; 3/8"; 1/2" e 1 punho 1/4"
 7 Extensões e 3 adaptadores

CARROS



C-DC2B



MEC POLEGADAS

Cor: preto



1 500.00€

MEC PROF20

Composição de ferramentas profissionais para mecânico



TABULEIROS



Composição: 210 peças

Tabuleiro com

Jogo chaves de caixa longa 1/4" e 1/2" de 6 a 27mm
 Jogo chaves de caixa 1/4", 1/2" e 3/4" de 6 a 36mm
 Jogo extensões de 1/4", 1/2" e 3/4"
 Adaptadores
 Cardans
 Jogo chaves de caixa torx de 1/4" e 1/2" de E5 a E 24

Tabuleiro com

Jogo chaves fenda, Philips e torx com punho
 Chave de caixa com punho

Tabuleiro com

Jogo alicates longos, universal, pontas, corte, pressão, ajustável
 Chave de filtros

Tabuleiro com

Jogo de roquetes 1/4", 3/4", 1/2", 3/8"
 Roquete extensível de 1/2"
 Jogo bits curtos e longos 1/2"
 Jogo chaves de caixa torx de 1/2"
 Jogo chaves ribe de 1/2"
 Jogo chaves estriadas de 1/2"
 Jogo de chaves de hexagonais 1/2"

Tabuleiro com

Jogo chaves mistas de 6 a 34mm

Tabuleiro com

Jogo chaves luneta de 10 a 22mm
 Jogo alicates de freios
 Jogo de chaves de hexagonais curtas
 Apalpa folgas
 Martelo pena esférica
 Chave inglesa

CARROS



C-6DWB1



C-7DC2B



MEC PROF20-V

Cor: verde



2 426.00€

MEC PROF20-C

Cor: cinza



2 426.00€

MEC PROF20-BLACK

Cor: preto



2 210.00€

ELECTR. 1000volts

Composição de ferramentas profissionais isolada a 1000volts

TABULEIROS

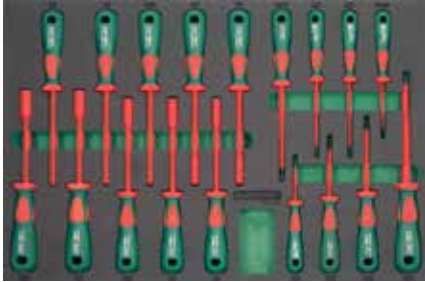

DV4118SV



S03V4124SV



S03V3136SV



W25V1125SV

Composição: 103 peças

DV4118SV

Tabuleiro com 18 chaves isoladas

4 Chaves de fenda

4 Chaves phillips

10 Chaves de caixa de punho

S03V3136SV

Tabuleiro com 36 peças 1/4" e 3/8"

2 Roquete 1/4" e 3/8"

2 Cabo T de 1/4" e 3/8"

1 Extensão 100mm de 1/4"

10 Chaves de caixa 1/4"

4 Bits de caixa 1/4"

2 Extensões 3/8"

11 Chaves de caixa 3/8"

4 Bits de caixa 3/8"

S03V4124SV

Tabuleiro com 24 peças 1/2"

1 Roquete

1 Cabo T

2 Extensões

13 Chaves de caixa

5 Bits de caixa

1 Chave inglesa

1 X-ato

W25V1125SV

Tabuleiro com 25 peças

9 Chaves de bocas

13 Chaves de luneta

1 Alicate universal

1 Alicate de corte

1 Alicate de pontas

CARROS



C-6DWB1



C-7DC2B

ELECTR. 1000-V

Cor: verde



2 640.00€

ELECTR. 1000-C

Cor: cinza



2 640.00€

ELECTR. 1000 BLACK

Cor: preto



2 380.00€

HV 1000V

Composição básica de ferramentas profissionais isolada a 1000volts

TABULEIROS



Composição: 43 peças

Tabuleiro com

Jogo de alicate de pontas, universal e de corte
 Jogo chaves fenda e Philips
 Jogo chaves de caixa com punho
 Busca polos



Tabuleiro com

Multímetro digital
 Jogo de extensões
 Roquete
 Navalha
 Jogo chaves de caixa 1/2" de 8 a 22mm
 Jogo chaves luneta de 8 a 14mm
 Jogo chaves bocas de 8 a 14mm
 Jogo chaves hexagonais de 4 a 8mm
 Chave ajustável

CARROS



C-6DWB1



C-7DC2B



HV1000V-V

Cor: verde



1 878.00€

HV1000V-C

Cor: cinza



1 878.00€

HV1000V-BLACK

Cor: preto



1 655.00€



ELECTR

Composição de ferramentas profissionais para eletricista

TABULEIROS



Composição: 144 peças

Tabuleiro com

Jogo alicates universal, pontas e corte
Mini alicates
Alicate de descarnar
Alicate de cravar terminais

Tabuleiro com

Jogo chaves mistas de 10 a 22mm
Jogo chaves de precisão
Chaves fenda e Philips

Tabuleiro com

Jogo de bits com adaptadores
Jogo chaves de boca perfil fino de 10 a 19mm
Jogo chaves caixa 1/2" de 17 a 30mm
Jogo chaves de caixa 3/8" de 11 a 16mm
Jogo de roquetes e extensões

Tabuleiro com

Bandeja magnética
Gambiarras leds
Multímetro digital
X-acto
Tesoura
Raspador com lâminas

CARROS



C-6DWB5



C-7DC2B



ELECTR-V

Cor: verde



2 085.00€

ELECTR-C

Cor: cinza



2 085.00€

ELECTR-BLACK

Cor: preto



1 831.00€

CHAPEIRO 20

Composição de ferramentas profissionais para chapeiro (ferro)



TABULEIROS



Composição: 55 peças

Tabuleiro com

Lima de chapéiro
Jogo de martelos chapeiro
Chaves cavilhas

Tabuleiro com

Jogo alicates universal, de pontas e de corte
Desandador de percussão
Jogo alicates de pressão

Tabuleiro com

Jogo de ventosas
Jogo chaves fenda e Philips de pancada
Jogo de ferramentas para remoção de frisos plásticos

Tabuleiro com

Jogo encontradores para ferro
Kit remoção de vidros para brisas

CARROS



C-4DWA1



C-7DC2B



CHAPEIRO20-V

Cor: verde



1 795.00€

CHAPEIRO20-C

Cor: cinza



1 795.00€

CHAPEIRO20- BLACK

Cor: preto



1 735.00€



CHAPEIRO ALU

Composição de ferramentas profissionais para chapeiro (alumínio)

TABULEIROS



Composição: 57 peças

Tabuleiro com

Lima de chapeiro
Jogo de martelos chapeiro
Chaves cavilhas

Tabuleiro com

Jogo alicates universal, de pontas e de corte
Desandador de percussão
Jogo alicates de pressão

Tabuleiro com

Jogo de ventosas
Jogo chaves fenda e Philips de pancada
Jogo de ferramentas para remoção de frisos plásticos

Tabuleiro com

Jogo encontradores para alumínio
Kit remoção de vidros para brisas

CARROS



C-4DWA1



C-7DC2B



CHAPEIROALU-V	Cor: verde		1 835.00€
CHAPEIROALU-C	Cor: cinza		1 835.00€

CHAPEIROALU-BLACK	Cor: preto		1 785.00€
--------------------------	------------	--	-----------

PINTOR20

Composição de ferramentas profissionais para pintor

TABULEIROS



Composição: 47 peças

Tabuleiro com

Jogo de espátulas remoção de frisos
Espelho auxiliar de reparação de
mossas
Jogo chaves para remoção de
cavilhas e molas

Tabuleiro com

Pistola pintura
Base para lixa
Jogo de 4 espátula
Lixadora orbital
Saca terminais de cabo de baterias

Tabuleiro com

Jogo chaves luneta de 6 a 32mm
X-acto
Jogo chaves fenda e Philips

Tabuleiro com

Jogo de 6 ventosas e acessórios

CARROS



C-4DWA1



C-7DB2B

PINTOR20-V

Cor: verde



1 722.00€

PINTOR20-C

Cor: cinza



1 722.00€

PINTOR20-BLACK

Cor: preto



1 665.00€

MEC PESADOS Composição de ferramentas profissionais para pesados

TABULEIROS



Composição: 162 peças

Tabuleiro com

Jogo chaves caixa de 1/2" de 8 a 34mm com roquete e extensão
 Jogo chaves torx macho 1/2" de T30 a T80
 Jogo chaves macho hexagonais de 1/2" de H5 a H19
 Cardan
 Rabo de força

Tabuleiro com

Jogo chaves caixa de impacto longas de 1/2" e 3/4" de 10 a 46mm
 Adaptadores
 Extensão
 Cardan

Tabuleiro com

Jogo de martelos, marreta e alicates

Tabuleiro com

Jogo chaves fenda e Philips de pancada
 Jogo chaves Hexagonais de impacto, chave de filtro

Tabuleiro com

Jogo chaves luneta de 6 a 32mm
 Jogo chaves de bocas de 6 a 32mm

Tabuleiro com

Jogo chaves de 3/4" de 19 a 50mm com extensões, adaptadores, cardan e roquete

Tabuleiro com

Jogo chaves mistas de 20 a 46mm

CARROS



MEC PESADOS 20A

Cor: verde



3 838.00€

MEC PESADOS 20B

Cor: verde



3 650.00€

C-1DM1

395.60€

Gaveta lateral de apoio de laptop/ tablet até 14"
Adicional para carros de ferramentas
Dimensões gaveta: 410x285x70



* Exemplo de aplicação em carro de ferramentas

C-3DW5

855.00€

Carro vazio para ferramenta

Dimensões totais: 670x460x960mm
Peso: 54,2kg
3 Gavetas de 576x380x75mm
1 Arrumos com 2 portas de 603x404x478mm



C-4DWA1

Cor: verde 

780.00€

C-4DWA1G

Cor: cinza 

780.00€

Carro vazio para ferramenta com 4 gavetas
Tampo especial preparado para banca de trabalho

Dimensões totais: 670x460x795mm
2 Gavetas de 579x380x56mm
1 Gaveta de 579x380x123mm
1 Gaveta de 579x380x179mm



C-6DWB1

Cor: verde 

958.00€

C-6DWB1G

Cor: cinza 

958.00€

Carro vazio para ferramenta com 6 gavetas

Tampo especial preparado para banca de trabalho

Dimensões totais: 670x460x967mm
4 Gavetas de 579x380x56mm
1 Gaveta de 579x380x123mm
1 Gaveta de 579x380x179mm



C-6DWB5

936.00€

Carro vazio para ferramenta com 6 gavetas

Tampo revestido a plástico e suporte para ferramenta

Dimensões totais: 670x460x967mm
4 Gavetas de 579x380x56mm
1 Gaveta de 579x380x123mm
1 Gaveta de 579x380x179mm



C-7DC2B

Cor: preto 

680.00€

Carro vazio para ferramenta com 7 gavetas

Dimensões totais: 670x460x963mm
5 Gavetas de 576x380x75mm
2 Gavetas de 576x380x154mm
Peso total: 57kg
Capacidade de carga: 140kg/roda
Dimensão rodas: 127x25,5mm



C-7DS1

1 260.00€

Carro vazio para ferramenta com 7 gavetas

Tampo em aço

Dimensões totais: 710x500x967mm
1 Painel lateral perfurado
1 Painel lateral para compartimentos de arrumos
4 Rodas, 2 direcionais com travão
Peso total: 74,5kg
Capacidade de carga: 160kg/roda



* As caixas laterais são opção

C-7DW9

1 115.00€

Carro vazio para ferramenta com 7 gavetas

Sistema de segurança, abertura de 1 só gaveta

Dimensões totais: 670x460x967mm

5 Gavetas de 576x380x75mm

2 Gavetas de 576x380x154mm

Peso total: 74,5kg

Capacidade de carga: 75kg/roda

Dimensão rodas: 127x50,8mm



C-7 TOWER

1 515.00€

Carro vazio com 13 gavetas

Dimensões totais: 670x460x1 334mm

5 Gavetas de 576x380x75mm

2 Gavetas de 576x380x154mm

Caixa superior

3 Gavetas de 170x275x50mm

2 Gavetas de 569x275x50mm

1 Gaveta de 569x275x75mm



C-10DW42

2 176.00€

Carro grande vazio para ferramenta com 10 gavetas

Dimensões totais: 1 070x460x981mm

1 Compartimento arrumação de 316x404x1 150mm

5 Gavetas de 288x380x75mm

2 Gavetas de 576x380x154mm

1 Gaveta de 288x380x154mm

1 Gaveta de 576x380x154mm

1 Gaveta de 928x380x173mm



C-A16W

620.00€

Armário com 7 gavetas

Inclui 2 rodas para acoplamento aos carros C-7/ C-6

5 Gavetas de 288x380x75mm

2 Gavetas de 288x380x154mm



C-13DW53

2 834.00€

Carro grande vazio para ferramenta com 13 gavetas

Dimensões totais: 1 358x460x1 150mm

10 Gavetas de 576x380x75mm

2 Gavetas de 579x380x154mm

1 Gaveta de 1 216x380x173mm



C-A17W

Cor: verde



392.00€

C-A17WG

Cor: cinza



404.00€

Armário com 1 porta

Inclui 2 rodas para acoplamento aos carros C-7/ C-6



C-3DH1

102.30€

Caixa vazia para ferramenta 3 divisões

Dimensões totais: 250x320x250mm



C-3DH2

109.10€

Caixa metálica vazia para ferramenta com 5 compartimentos

Dimensões totais: 470x240x220mm



C-3DH262

477.20€

Caixa metálica para ferramenta com 5 compartimentos - 62 peças

Dimensões totais: 470x220x350mm

Composição

- P106 Alicete de corte
- P116 Alicete de pontas
- P087 Alicete universal
- D70 Jogo de 6 chaves fenda/ phillips
- W26 Jogo de 18 chaves mistas
- R2904 Roquete de 1/2"
- S04H41 Jogo de 18 chaves de caixa
- S15H472 Adaptador
- S24H4 Extensões
- S22H41450 Cabo articulado 450mm
- S23H41300 Cabo T corrediço 300mm
- S21H4150 Extensão
- S17H4121 Chave de velas 21mm
- H03SM109S Jogo de chaves hexagonais



Caixas, tornos e complementos para carros

C-3DH262V

549.50€

Caixa para ferramenta em EVA - 62 peças

Dimensões totais: 470x220x350mm

Composição

- P106 Alicete de corte
- P116 Alicete de pontas
- P087 Alicete universal
- D70 Jogo de 6 chaves fenda/ phillips
- W26 Jogo de 18 chaves mistas
- R2904 Roquete de 1/2"
- S04H41 Jogo de 18 chaves de caixa
- S15H472 Adaptador
- S24H4 Extensões
- S22H41450 Cabo articulado 450mm
- S23H41300 Cabo T corrediço 300mm
- S21H4150 Extensão
- S17H4121 Chave de velas 21mm
- H03SM109S Jogo de chaves hexagonais



C-3DH5

207.00€

Caixa metálica vazia para ferramenta com 3 gavetas

Compartimento no topo

Dimensões totais: 535x220x290mm

3 Gavetas de 505x195x45mm



C-3DH6

83.70€

Caixa vazia para Ferramenta

Dimensões totais: 355x160x242mm



C-T12

284.60€

Carro com 3 prateleiras

Dimensões totais:

Comprimento: 716mm

Largura: 410mm

Altura: 880mm

Peso: 20kg

Rodas: 4 (2 fixas+2 direcionais)



C-6DA4

409.40€

Caixa metálica vazia para ferramenta com 6 gavetas

Compartimento no topo com várias divisórias

Dimensões totais: 660x307x374mm

3 Gavetas de 172x270x41mm

2 Gavetas de 572x270x31mm

1 Gaveta de 572x270x65mm



C-6DA494

1 034.60€

Caixa de ferramenta com 6 gavetas - 98 peças

Compartimento no topo com várias divisórias

Dimensões totais: 660x307x374mm

Composição:

AG10002SC

D376514SC

R4811SC

P0813SC

S04H5129SC

V11011SC

W25117SC

W27AT02SC



C-A456

91.40€

Tampo plástico para carros de ferramenta

Aplicável aos carros C-4/ C-6 e C-7



C-A9

73.70€

Base para torno e suporte para rolo de papel



C-A27

67.20€

Tampo em acrílico resistente ao impacto para carros de ferramentas

Aplicável somente aos carros C-5DW/ C-6DW e C-7DW



C-7DW1-TS

136.90€

Tampo completo para carros de ferramentas

Aplicável somente aos carros C-5DW/ C-6DW e C-7DW

Composição

1 Tampo acrílico resistente ao impacto

1 Base metálica de apoio

1 Revestimento EVA de 2mm



C-A31

23.50€

Suporte lateral para chaves em T para fixação



C-A3

Cor: verde



26.00€

Pega para carro de ferramenta

Aplicável a C-4DW, C-6DW e C-7DW



C-A3-B

Cor: preto



26.70€

Pega para carro de ferramenta

Aplicável a C-7DB2 e C-7DC2

C-A3G

Cor: cinza



27.40€

Pega para carro de ferramenta

Aplicável a C-4DW, C-6DW e C-7DW

C-BS

Jogo de calhas direita e esquerda, para gavetas de carros e caixas

Ref.	Aplicação	Preço
C-BS Kit1	Carros: C-4DW/ C-5DW/ C-6DW/ C-7DW	24.60€
C-BS Kit2	Caixas: C-6DA4	16.70€
C-BS Kit3	Carros: C-10DW/ C-13DW	26.20€
C-BS Kit6	Gaveta: C-7DC2B	21.40€



C-PC

Canhão de fechadura

Ref.	Aplicação	Preço
C-PC1	C-6DA4	9.40€
C-PC2	C-5/ C-6/ C-7/ C-10/ C-13	9.90€
C-PC3	C-4	15.70€



C-PC4

18.40€

Canhão de fechadura para chaves tubulares

Inclui 2 chaves.



C-WHEEL

Rodas

Ref.	Tipo	Aplicação carro	Preço
C-WHEEL1	fixa	C-6/ C-7	21.10€
C-WHEEL2	travão	C-6/ C-7	28.60€
C-WHEEL5	fixa	C-4/ C-5/ C-7DB2	19.90€
C-WHEEL6	travão	C-4/ C-5/ C-7DB2	27.50€
C-WHEEL8	fixa	C-T3/ C-/12	17.00€
C-WHEEL9	travão	C-T3/ C-/12	19.00€



Caixas, tornos e complementos para carros

C-A

Torno de bancada

Ref.	Abertura (mm)	Peso (kg)	Preço
C-A7*	76	6	119.70€
C-A8*	101	7,25	145.40€
C-A10	127	10,2	186.10€
C-A11	152	14	224.40€
C-A12	203	18	299.10€
C-A13	254	24	398.50€

* Aplicável em carro de ferramenta (necessário suporte C-A9)



C-B

Torno de bancada com dupla rotação

Rotação 360° da base do torno

Rotação 360° da cabeça do torno

Ref.	Abertura (mm)	Peso (kg)	Preço
C-B5	127	17	233.60€



C-A2501S

31.00€

Conjunto de caixas plásticas para gavetas de carros de ferramenta

Composição

12 Caixas 93x93x43mm

4 Caixas 283x93x43mm

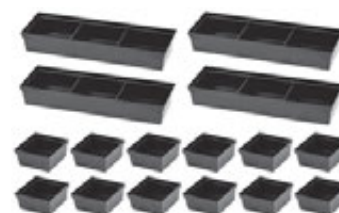

C-APB

32.70€

Conjunto de caixas plásticas para gavetas de carros de ferramenta

Composição

8 Caixas 283x93x43mm





JONNESWAY®

Ferramentas Profissionais

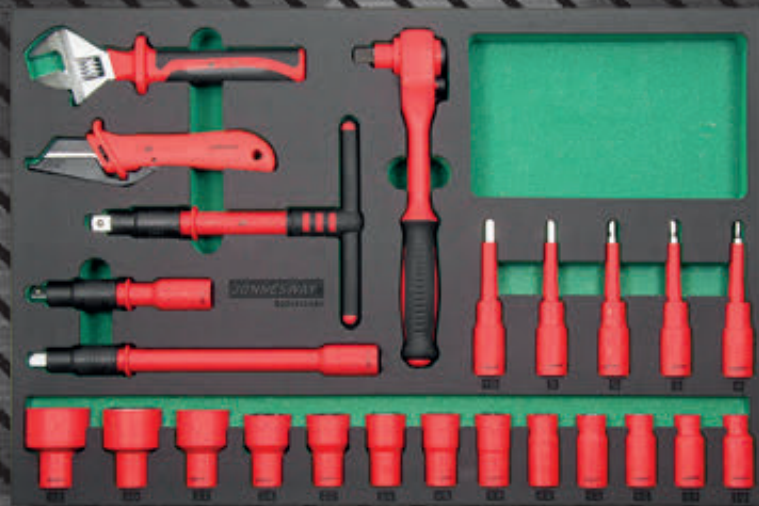



JONNESWAY®

Ferramenta Manual



**Tabuleiros de
ferramenta**



Chaves



**Ferramenta
de aperto**



**Martelos, punções
e escopros**



Alicates



**Corte, desbaste
e medida**



AG010002SP

60.40€

Jogo de 4 alicates de freios

Composição:

- AG010002 Alicates de freios interiores
- AG010005 Alicates de freios interiores de ponta curva
- AG010008 Alicates de freios exteriores
- AG010011 Alicates de freios exteriores de pontas curvas 90°

A



AG010026SP

71.40€

Jogo de martelos e talhadeiras

Composição:

- M09300 Martelo tipo alemão 300g
- M11035 Martelo com batentes de borracha 400g
- M61 Jogo de 3 talhadeiras

A



AG010150SC

137.80€

Jogo de 8 alicates de freios

Composição:

- 4 Alicates de pontas direitas
- 4 Alicates de pontas curvas

B



AG10001SP

143.20€

Jogo de machos e caçonetes

Composição:

- 17 Machos manuais: M3 a M12
- 17 Caçonetes: M3 a M12
- 1 Porta caçoneto
- 1 Desandador de machos
- 1 Punho desandador

B



AI10001SP

252.10€

Jogo de ferramentas para substituição de válvulas da cabeça do motor

Composição:

- AN010064 Compressor de válvulas da cabeça do motor
- AI020056 Alicates para vedantes de válvulas
- AI020099 Adaptador de mola de válvula
- AI020100 Suporte de válvulas
- AI010012A Removedor de pastilhas de válvula

B



AI10002SP

204.30€

Jogo de ferramentas para substituição da polie da correia da cambota

Composição:

- AE310030 Saca de 2 pernas
- AE10035-1 Complemento para 3 pernas
- AN010038 Saca vedante
- AI020087A Saca polie da cambota

B



AI10003SP
158.70€
Jogo de chaves de copo para filtros

Composição:

- 9 Chaves de copo para filtros
- 14 Chaves para bujão do carter
- 1 Chave de filtros

B

Description			
<input type="radio"/> 8mm	BMW, Ford	<input type="checkbox"/> 10mm	Renault
<input type="radio"/> 9mm	General Motor	<input type="checkbox"/> T-Bar To Drive	
<input type="radio"/> 10mm	Ford	<input type="checkbox"/> 30-160mm Oil Filter Chain 3/8" Oil	
<input type="radio"/> 12mm	Fiat, Lancia, Peugeot	<input type="checkbox"/> Filter Cap Wrench	
<input type="radio"/> 14mm	Mercedes, Lancia	<input type="checkbox"/> 93mm-15	GM, Nissan, Volvo, Mazda, Audi, VW, etc
<input type="radio"/> 17mm	BMW, Austin, Audi, VW	<input type="checkbox"/> 76mm-14	VW, Porsche, Mercedes, BMW, Toyota
<input type="radio"/> 3/8"	General Motor	<input type="checkbox"/> 75,6mm-14	Mazda, General Motor
<input type="checkbox"/> 10mm	BMW, Renault, Toyota	<input type="checkbox"/> 38mm	etc Diesel Engine
<input type="checkbox"/> 8mm	Citroen, Peugeot, Renault, Talbot, Volvo	<input type="checkbox"/> 36mm	Benz, VW, BMW/M52, M60, M73
<input type="checkbox"/> 11mm	Ford	<input type="checkbox"/> 32mm	GM, Saab, Saturn
<input type="checkbox"/> 13mm	Nissan, Subaru	<input type="checkbox"/> 30mm	General Motor
<input type="checkbox"/> 3/8"	Honda, Mazda, Renault, Saab, Volvo	<input type="checkbox"/> 27mm	Mercedes
<input type="checkbox"/> 7mm	General Motor	<input type="checkbox"/> 24mm	BMW/ 5 & 7 séries

AN100002SP
246.50€
Jogo de 42 peças de ferramenta para travões

Este tabuleiro ocupa meia gaveta do carro de ferramentas.

C

D70105SP
48.30€
Jogo de 5 chaves fenda/ phillips impacto

Composição/ medidas em mm:

- | | | | |
|-------------|--------------------|-------------|--------------------|
| D70S | 3 Chaves de fenda: | D70P | 2 Chaves phillips: |
| | 6,5x125 | | PH 2x100 |
| | 8x150 | | PH 3x150 |
| | 9,5x175 | | |

A

D71PP08SP
45.10€
Jogo de 8 chaves fenda/ phillips

Composição/ medidas em mm:

- | | | | |
|-------------|--------------------|-------------|--------------------|
| D71S | 4 Chaves de fenda: | D71P | 4 Chaves phillips: |
| | 6,5x38 | | 2x38 |
| | 4x80 | | 1x80 |
| | 5,5x125 | | 2x100 |
| | 6,5x150 | | 3x150 |

A

Tabuleiros de ferramenta para carros
D725N08SP
94.70€
Jogo de 8 chaves de caixa de punho

Composição:

Chaves de 6 a 13mm

C

H10MB08SP
55.40€
Jogo de 8 chaves macho hexagonal com extremidade esférica e punho

Composição/ medidas em mm:

- | | | |
|--------------|---------|--------|
| H10MB | 2x100 | 5x150 |
| | 2,5x100 | 6X150 |
| | 3x100 | 8X200 |
| | 4x100 | 10X200 |

B

H10MT08SP
54.70€
Jogo de 8 chaves torx duplas tamperproof com punho

Composição/ medidas em mm:

- | | | |
|--------------|---------|---------|
| H10MT | T10x100 | T27x150 |
| | T15x100 | T30X150 |
| | T20x100 | T45X200 |
| | T25x100 | T50X200 |

B

H20MT08SP
58.30€
Jogo de 8 chaves torx duplas de punho

Composição/ medidas em mm:

- | | |
|---------|---------|
| T10x110 | T27x145 |
| T15x120 | T30X155 |
| T20x125 | T45X185 |
| T25x135 | T50X205 |

B

M09513SP

101.20€

Jogo de martelos e punções

Composição:

- M07016 Martelo com batentes de plástico
- M09500 Martelo de mecânico tipo "alemão"
- M63M106S Jogo saca troços cromados
- M64M105S Jogo punções e escopros cromados

A



M645114SP

102.90€

Jogo de serra, chave inglesa, punções e escopros

Composição:

- M63 6 Punções
- M64 4 Escopros
- W27AS10 Chave inglesa
- MHS100AG Serra

B



MTC101SP

253.10€

Jogo de ferramenta de medição

Composição/ medidas em mm:

- Paquímetro digital 150
- Esquadro metálico 300
- Régua metálica 300
- Compasso 200
- Micrómetro 0-25
- Micrómetro 25-50
- Lapiseira

B



P018SP1

80.00€

Jogo de 3 alicates e 7 chaves hexagonais

Composição:

- P018 Alicate universal
- P038 Alicate de corte diagonal
- P068 Alicate de pontas
- H01SM109S Chaves hexagonais

A



P018SP

66.90€

Jogo de 3 alicates

Composição:

- P018 Alicate universal
- P038 Alicate de corte diagonal
- P068 Alicate de pontas

A



P04704SP

77.30€

Jogo de 4 alicates de corte

Não utilizar em metal.

A



P0803SP

63.40€

Jogo de 3 alicates isolados

Composição:

- P087 Alicate universal
- P097 Alicate de corte diagonal
- P118 Alicate de pontas

A



P0903SP

71.10€

Jogo de 3 alicates isolados

Composição:

- P0118 Alicate universal
- P0918 Alicate de corte diagonal
- P1118 Alicate de pontas

A



P2710SP

46.20€

Jogo de 2 alicates

Composição:

- P2710 Alicate ajustável
- P32M10A Alicate de pressão

A



P2803SP
70.60€
Jogo de 2 alicates e chave inglesa

Composição:

W27AS10 Chave inglesa
P2810 Alicates ajustável
P32M10A Alicates de pressão

A

S03A4122SP
103.60€
Jogo de 22 chaves de impacto 1/2"

Composição/ medidas em mm:

S03A4 Chaves: 10; 11; 12; 13; 14; 16; 17; 19; 21; 22 e 24
S03AD4 Chaves: 10; 11; 12; 13; 14; 16; 17; 19; 21; 22 e 24

A

S04H2125SP
62.40€
Jogo de chaves de caixa com 24 peças de 1/4"

Composição/ medidas em mm:

R3702 Roquete de 48 dentes
S04H2 Chaves de caixa: 4; 5; 5,5; 6; 7; 8; 9; 10; 11; 12 e 13
S04HD2 Chaves de caixa: 5; 6; 7; 8; 9; 10; 11; 12 e 13
S24H250 Extensão 50
S24H2150 Extensão 150
S26H2150 Punho

A

S04H3157SP
141.50€
Jogo de 8 chaves de caixa com 56 peças de 1/4" e 3/8"

Composição/ medidas em mm:

R3702 Roquete 1/4" de 48 dentes
S04H2 Chaves 1/4": 4; 4,5; 5; 5,5; 6; 7; 8; 9; 10; 11; 12 e 13
S04HD2 Chaves 1/4": 8; 10; 12 e 13
S09H2 Bits hexagonais: 3; 4; 5 e 6
S07H2 Bits torx: T10; T15; T20; T25; T27 e T30
S10H2 Bits fendas: 4; 5,5 e 7
S11H2 Bits phillips: PH1; PH2 e PH3
S24H2 Extensões
 Adaptador de extensão
S16H302 Adaptador universal
 Punho
R3703 Roquete 3/8" de 48 dentes
S04H3 Chaves 3/8": 14; 15; 17; 18; 19; 20; 22 e 24
S04HD3 Chaves 3/8": 14; 15 e 17
S17H3 Chaves de velas: 16 e 21
S24H3 Extensões
 Adaptador extensão 3/8" - 1/2"
S15H356 Adaptador universal

B

S04H3536SP
124.30€
Jogo de chaves de caixa e chaves mistas com 36 peças de 3/8"

Composição/ medidas em mm:

R3503 Roquete de 72 dentes
S04H3 Chaves de caixa: 6 a 22
S24H3 Extensões
 Adaptador de extensão 1/2" - 3/8"
S17H3 Chaves de velas: 16 e 21
S15H356 Adaptador universal
W26 Chaves mistas boca/ luneta: 7 a 17

B

S04H4125SP
113.30€
Jogo de chaves de caixa com 25 peças de 1/2"

Composição/ medidas em mm:

R3704 Roquete de 48 dentes
S04H4 Chaves: 10; 11; 12; 13; 14; 15; 16; 17; 18; 19; 20; 21; 22; 23; 24; 27; 30 e 32
S24H4 Extensões
S17H4 Chaves de velas: 16 e 21
S23H4125 Cabo "T" corrediço
S15H472 Adaptador universal

B

S04H4131SP

149.70€

Jogo de chaves e roquete com 31 peças de 1/2"

Composição/ medidas em mm:

- Roquete de 72 dentes
- Chaves de caixa: 10 a 32
- Chaves de velas: 16 e 21
- Cardan
- Extensão de 125
- Extensão de 250
- Cabo "T" corrediço de 250
- Bits hexagonais de 5; 6; 8; 10 e 12

C



S04H4524SP

126.60€

Jogo de chaves sextavadas com 24 peças de 1/2"

Composição/ medidas em mm:

- R3704 Roquete de 48 dentes
- S04H4 Chaves: 10; 11; 12; 13; 14; 15; 16; 17; 18; 19; 20; 21; 22; 23; 24; 27; 30 e 32
- S24H4 Extensões 5" e 10"
- S15H472 Adaptador universal
- S22H41375 Punho flexível 15"
- S23H41300 Cabo "T" corrediço

B

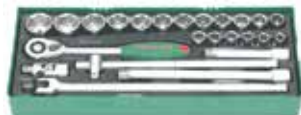

S04H4726SP

130.50€

Jogo de chaves de caixa com 26 peças de 1/2"

Composição/ medidas em mm:

- R3704 Roquete de 48 dentes
- S04H4 Chaves de caixa: 12; 13; 14; 15; 16; 17; 18; 19; 20; 21; 22; 23; 24; 25; 26; 27; 28; 30 e 34
- S24H4 Extensões 5" e 10"
- S17H4116 Chave de velas 16
- S15H472 Adaptador universal
- S23H41300 Cabo "T" corrediço
- S41H4 Manivela de punho metálico

B



S04H4728SP

126.70€

Jogo de chaves de caixa sextavadas com 28 peças de 1/2"

Composição/ medidas em mm:

- R3704 Roquete de 48 dentes
- S04H4 Chaves de caixa: 8; 9; 10; 11; 12; 13; 14; 15; 16; 17; 18; 19; 20; 21; 22; 23; 24; 25; 26; 27; 28; 30; 32 e 34
- S24H4250 Extensão 10"
- S15H472 Adaptador universal
- S23H41300 Cabo "T" corrediço

B



S06H427SP

106.00€

Jogo de chaves de caixa bits com 27 peças de 1/2" e 3/8"

Composição:

- S09H4 Bits hexagonais de 1/2"
- S49H4 Bits estriados de 1/2"
- S09H3 Bits hexagonais de 3/8"

A



S09H4118SP

78.30€

Jogo de chaves de caixa bits hexagonais com 18 peças de 1/2"

Composição:

- Chaves 55mm: H5; H6; H7; H8; H10; H12; H14; H17 e H19
- Chaves 100mm: H5; H6; H7; H8; H10; H12; H14; H17 e H19

A



S29H4140SP

58.30€

Jogo 40 bits de 3/8" para quadra de 1/2" e 3/8"

Composição:

- Bits hexagonais
- Bits torx
- Bits estriados
- Porta bits

A



V1311SP 169.20€

Jogo de alicates de cravar e descarnar

Composição:

V1310 Alicates de cravar terminais isolados e não isolados

V1401 Alicates de descarnar fios

AG010031A Pesca magnético com espelho

Teste para circuitos

Kit com 60 terminais

B



W23108SP 75.00€

Jogo de 8 chaves de luneta 75°

Composição/ medidas em mm:

W23 Chaves: 6x7; 8x9; 10x11; 12x13; 14x15; 16x17; 18x19 e 20x22

A



W24A109SP 175.20€

Jogo de 9 chaves de luneta aberta flexível

Composição/ medidas em mm:

W24A Chaves: 8x8; 10x10; 11x11; 12x12; 13x13; 14x14; 17x17; 19x19 e 22x22

A



W25110SP 68.90€

Jogo de 10 chaves de bocas

Composição/ medidas em mm:

W25 Chaves: 6x7; 8x9; 10x11; 12x13; 14x15; 16x17; 18x19; 21x23; 24x27 e 30x32

A



W26112SP 70.10€

Jogo de 12 chaves mistas de boca/ luneta

Composição/ medidas em mm:

W26 Chaves: 8; 9; 10; 11; 12; 13; 14; 15; 16; 17; 19 e 22

A



W26116SP 89.70€

Jogo de 16 chaves mistas de boca/ luneta

Composição/ medidas em mm:

W26 Chaves: 6; 7; 8; 9; 10; 11; 12; 13; 14; 15; 16; 17; 18; 19; 22 e 24

B



W45112SP 170.60€

Jogo de 12 chaves mistas de boca/ roquete de 72 dentes

Composição/ medidas em mm:

W45 Chaves: 8 a 19

A



W47108SP 95.20€

Jogo de 8 chaves de luneta angular com roquete

Composição/ medidas em mm:

W47 Chaves: 6x7; 8x9; 10x11; 12x13; 14x15; 16x18; 17x19 e 21x22

A



W106115SP 215.60€

Jogo de 15 chaves de boca/ roquete reversível de 72 dentes

Composição/ medidas em mm:

W60 Chaves: 9 a 19

Adaptadores de 1/4"; 3/8" e 1/2"

Porta bits de 10

B



W70A118S 305.10€

Jogo de chaves em "T" com roquete articulado

Composição/ medidas em mm:

W60 Chave em "T" de 300

Chave em "T" de 50

Chave com roquete de 72 dentes

Extensão de 3"

Extensão de 6"

Adaptador 3/8" (F)x3/8" (F)

B



Tabuleiros em espuma de alta densidade EVA

JA-C131SV

743.50€

Gaveta para serviço em pneus (gaveta completa)

Composição:

- JAI-0924 Pistola pneumática de 1/2"
- JAR-6309A Roquete pneumático de 1/2"
- JAG-0906R Retificadora pneumática de 1/4"
- Chaves de impacto longas de 1/2"
- Chaves de impacto de 1/2"
- Adaptador de 3/8"-1/2"
- Adaptador de 1/2"-3/8"
- Adaptador de 1/2"-3/4"
- Cardan de 1/2"
- Extensões de 1/2"

D



D71157SV

248.00€

Gaveta com chaves de fenda/ phillips, alicates e bits (gaveta completa)

Composição/ medida em mm:

- Chaves de fenda: 6,5x38; 4x80; 5,5x125 e 6,5x150
- Chaves phillips: PH2x38; PH1x80; PH2x100 e PH3x150
- Chaves de fenda/pancada: 6,5x125; 8x150 e 9,5x175
- Chaves phillips/pancada: PH2x100 e PH3x150
- Bits hexagonais: 4; 5; 6; 7; 8; 10 e 12 de 30 e 75mm de comprimento
- Bits torx: T20; T25; T30; T40; T45; T50 e T55 de 30 e 75mm de comprimento
- Bits XZN: M5; M6; M8; M10 e M12 de 30 e 75mm de comprimento
- Porta bits de 3/8" e 1/2"
- Alicates de freios

D



D737128SV

232.60€

Gaveta com chaves de fenda/ phillips (gaveta completa)

Composição:

- D71PP08SP Jogo de chaves de fenda/ phillips
- D70105SP Jogo de chaves de fenda/ phillips pancada
- M645114SP Jogo de serra, chave inglesa, punções e escopros

D



D737134SV

227.90€

Gaveta com chaves de fendas/ phillips (gaveta completa)

Composição:

- D3750P065S Jogo de chaves de precisão
- D3750T08S Jogo de chaves de precisão
- D70105SP Jogo de chaves de fenda/ phillips pancada
- D71PP08SP Jogo de chaves de fenda/ phillips
- W43A106S Jogo de chaves de caixa flexível
- W43A0607 Chave flexível 06x07

D



H10121SV

191.10€

Gaveta com chaves macho hexagonais de punho, talhadeiras e martelos (gaveta completa)

Composição:

- H10MB08S Jogo de chaves duplas hexagonais de punho
- H10MT08S Jogo de chaves duplas torx tamperproof de punho
- AG010026S Jogo de martelos e talhadeiras

D



P82714SV

291.80€

Gaveta com alicates (gaveta completa)

Composição:

- P018SP Jogo de alicates
- P2710SP Jogo de alicates
- AG010002SP Jogo de alicates de freios
- P71 Jogo de mini alicates

D



P82736SV

322.90€

Gaveta com alicates e bits de caixa (gaveta completa)

Composição:

S06H427SP Jogo de chaves de caixa bits de 1/2" e 3/8"

AG010002SP Jogo de alicates de freios

P018SP Jogo de alicates

P2710SP Jogo de alicates

D



S04H2184SV

229.10€

Gaveta com 74 peças de 1/4" (gaveta completa)

Composição:

Roquete de 1/4"

Chaves de caixa de 1/4": 4 a 14mm

Bits de caixa hexagonais de 1/4": H2 a H6

Adaptador 3/8"(F) x 1/4" (M)

Adaptador 1/4" (M) x 3/8" (F) para cabo "T" corrediço

Cardan de 1/4"

Extensões de 1/4": 100mm e 150mm

Manivela 1/4": 150mm

Cabo "T" corrediço de 1/4": 130mm

Punho de 1/4" com função fixa/cardan 280mm

Extensão flexível de 1/4": 145mm

Bits phillips, fenda, pozidrive, hexagonais, torx

Chaves de precisão fenda/ phillips

Chaves de fenda/ impacto 9,5x200mm e 9,5x300mm

Chave de fenda 5x150mm

Chave de fenda isolada 1000V 5,5x125mm

D



S04H4295SV

305.50€

Gaveta com chaves de caixa e roquete (gaveta completa)

Composição:

S04H2125SP Jogo de chaves de caixa com 25 peças de 1/4"

S04H4131SP Jogo de chaves de caixa com 31 peças de 1/2"

S29H4140SP Jogo de 40 bits de 1/2" e 3/8"

D



S04H3194SV

278.70€

Gaveta com 94 peças de 1/4" e 3/8" (gaveta completa)

Composição:

Roquete de 1/4"

Chaves de caixa de 1/4": 5 a 14mm

Bits de caixa fenda de 1/4": 3,5; 5,5 e 7mm

Bits de caixa hexagonais de 1/4": H3, H4, H5, H6 e H7

Bits de caixa phillips de 1/4": PH1; PH2 e PH3

Bits de caixa torx interior de 1/4": E4; E5; E6; E7 e E8

Bits de caixa torx de 1/4": T10; T15; T20; T25; T30; T35 e T40

Punho de 1/4" com função fixa/ cardan 280mm

Bits torx tamperproof com encaixe de 1/4": T7 a T40

Bits phillips com encaixe de 1/4": PH1; PH2 e PH3

Cabo "T" corrediço de 1/4": 115mm

Extensão de 1/4": 150mm

Cardan de 1/4"

Bits e porta bits de 1/4"

Bit torx tamperproof de 3/8": T55

Roquete de 1/4" de 36 dentes

Adaptador 3/8" x 1/4"

Chaves caixa 3/8": 7 a 22mm

Chaves torx interior 3/8": E10; E12 e E14

Chave torx 3/8": T40

Bits caixa XZN 3/8": M6; M8 e M10

Extensões 3/8": 75mm e 150mm

Roquete e roquete flexível de 3/8" com 36 dentes

Cardan de 3/8"

Adaptador 1/4" (F) x 3/8" (M)

D



S04H42165SV

299.10€

Gaveta com 65 peças de 1/4" e 1/2" (gaveta completa)

Composição:

Roquete de 1/4" de 48 dentes

Chaves de caixa 1/4": 4 a 13mm

Chaves de caixa longas de 1/4": 5 a 13mm

Extensões de 1/4": 50mm e 150mm

Punho de 1/4"

Roquete de 1/2" com 48 dentes

Chaves de caixa 1/2": 10 a 32mm

Chaves de velas 1/2": 16 e 21mm

Extensões de 1/2": 125mm e 250mm

Cabo "T" corrediço

Cardan de 1/2"

Chaves mistas de 6 a 24mm

D



Tabuleiros em espuma de alta densidade EVA

S04H46121SV

386.20€

Gaveta com chaves de caixa e roquete (gaveta completa)

Composição:

S04H3157SP Jogo de chaves de caixa com roquete de 1/4" e 3/8"

S04H4125SP Jogo de chaves de caixa com roquete de 1/2"

S29H4140SP Jogo de 40 bits de 1/2" e 3/8"

D



W23559SV

276.30€

Gaveta com chaves de fenda/ phillips/ luneta e alicates (gaveta completa)

Composição:

D71PP08SP Jogo de chaves fenda e phillips

W23108SP Jogo de chaves luneta 75°

P0903SP Jogo de alicates

S29H4140SP Jogo de bits de 1/2" e 3/8"

D



W26134SV

294.90€

Gaveta com chaves de luneta/ mistas/ alicates (gaveta completa)

Composição:

W23108SP Jogo de chaves luneta 75°

P0903SP Jogo de alicates

W26112SP Jogo de chaves mistas (boca/ luneta)

H01SM109S Jogo de chaves hexagonais

P28210 Alicata ajustável

P32M10A Alicata de pressão

D



W2623431SV

262.50€

Gaveta com chaves de luneta e mistas (gaveta completa)

Composição:

W23108SP Jogo de chaves luneta 75°

W24106S Jogo de chaves luneta aberta

W26116SP Jogo de chaves mistas boca / luneta

AI050077 Cinta para filtros óleo

D



W26315SV

440.90€

Tabuleiro com 15 chaves mistas (gaveta completa)

Composição:

W26 20; 21; 23; 25; 26; 27; 28; 29; 30; 32; 36; 38; 41; 46 e 50mm

D

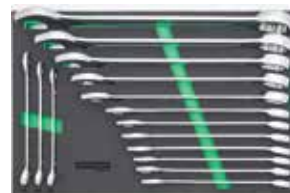

D70105KV

61.30€

Tabuleiro com 5 chaves pancada fenda/ phillips (1/3 de gaveta)

Composição:

D70S6125 Chave fenda 6,5x125mm

D70S8150 Chave fenda 8x150mm

D70S9175 Chave fenda 9,5x175mm

D70P2100 Chave phillips PH2x100mm

D70P3150 Chave phillips PH3x150mm

A



D70PS119KV

94.90€

Tabuleiro com 5 chaves fenda/ phillips e desandador (1/3 de gaveta)

Composição:

3 Chaves phillips pancada: PH1x75; PH2x100 e PH3x125

2 Chaves fenda pancada: 6,5x150 e 9,5x200

1 Desandador de percussão com 13 bits

A



D71PP08KV
55.70€
Tabuleiro com 8 chaves fenda/ phillips (1/3 de gaveta)

Composição:

D71S Jogo de 4 chaves fenda
6,5x38; 4x80; 5,5x125 e 6,5x150mm

D71P Jogo de 4 chaves phillips
PH1X80; PH2X38; PH2x100 e PH3x150mm

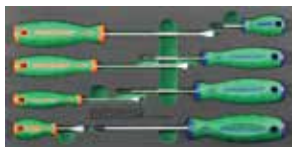
A

H10MB08KV
61.20€
Tabuleiro com 8 chaves hexagonais de punho (1/3 de gaveta)

Composição:

H10MB Jogo de 8 chaves macho
2x100; 2,5x100; 3x100; 4x100; 5x150; 6x150, 8x200
e 10x200mm

A

H10MT08KV
63.10€
Tabuleiro com 8 chaves torx tamperproof de punho (1/3 de gaveta)

Composição:

H10MT Jogo de 8 chaves torx
T10x100; T15x100; T20x100; T25x100; T27x150;
T30x150; T45x200 e T50x200mm

A

M09103KV
78.50€
Tabuleiro com martelos e chave inglesa (1/3 de gaveta)

Composição:

M09300 Martelo tipo alemão

M11035 Martelo borracha (anti recuo)

W27AS10 Chave inglesa

A

Tabuleiros de ferramenta para carros

Tabuleiros em espuma de alta densidade EVA
M63113KV
82.30€
Tabuleiro com saca troços, talhadeiras, punções e buril (1/3 de gaveta)

Composição:

6 Saca troços

4 Talhadeiras

1 Buril

1 Punção de bico

1 Punção

A

MHS08KV
85.50€
Tabuleiro com serra e vários (2/3 de gaveta)

Composição:

1 Serra com 2 lâminas extra

1 Fita métrica 3m

1 Régua 330mm

1 X-ato

B

P011804KV
99.00€
Tabuleiro com 4 alicates (1/3 de gaveta)

Composição:

P1118 1 Alicate de pontas

P0918 1 Alicate de corte diagonal

P0118 1 Alicate universal

P2710 1 Alicate ajustável

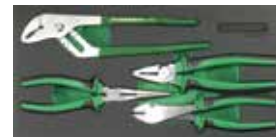
A

Tabuleiros em espuma de alta densidade EVA

P32M105KV

88.10€

Tabuleiro com 5 alicates (1/3 de gaveta)

Composição:

- AG010002 1 Alicata de freios interiores direito
- AG010005 1 Alicata de freios interiores curvo
- AG010008 1 Alicata de freios exteriores direito
- AG010011 1 Alicata de freios exteriores curvo
- P32M10A 1 Alicata de pressão

A



S03A4122KV

126.90€

Tabuleiro com 22 chaves de impacto 1/2" (1/3 de gaveta)

Composição:

- S03A Jogo chaves impacto
10; 11; 12; 13; 14; 16; 17; 19; 21; 22 e 24
- S03AD Jogo chaves impacto longa
10; 11; 12; 13; 14; 16; 17; 19; 21; 22 e 24

A



S04H2132KV

156.00€

Tabuleiro com 32 peças, chaves de bits e extensões (1/3 de gaveta)

Composição:

- S09H3 Chaves caixa bit hexagonais 3/8"
- S09H4 Chaves caixa bit hexagonais 1/2"
- S49H4 Chaves caixa bit estriado 1/2"
- S24H4 Extensões 1/2" - 125 e 250mm
- S17H4 Chaves velas - 16 e 21mm
- S23H4125 Cabo em "t" correção

A



S06H427KV

130.10€

Tabuleiro com 27 bits de caixa (1/3 de gaveta)

Composição:

- S09H3 6x Bits hexagonais de 3/8"
- S09H4 11x Bits hexagonais de 1/2"
- S49H4 10x Bits estriados de 3/8"

A



S04H4144KV

158.30€

Tabuleiro com 44 peças, chaves caixa com roquete (1/3 de gaveta)

Composição:

- R3704 Roquete 1/2"
- R3702 Roquete 1/4"
- S04H4 Chaves caixa 1/2"
10; 11; 12; 13; 14; 15; 16; 17; 18; 19; 20; 21; 22; 23; 24;
27; 30 e 32mm
- S04H2 Chaves caixa 1/4"
4; 5; 5,5; 6; 7; 8; 9; 10; 11; 12 e 13mm
- S04HD2 Chaves caixa longa 1/4"
5; 6; 7; 8; 9; 10; 11; 12 e 13mm
- S24H2 Extensões 1/4" - 50 e 150mm
- S26H2150 Punho 1/4"
- S15H472 Cardan 1/4"

A



S07H2138KV

104.90€

Tabuleiro com 18 peças, jogo de bits (1/3 de gaveta)

Composição:

- S06H2 7 Chaves de caixa torx int. 1/4": E4; E5; E6; E7; E8; E10 e E11
- S07H2 11 Bits caixa Torx de 1/4": T6; T7; T8; T9; T10; T15; T20 e T25
- S09H2 5 Bits caixa hexagonais de 1/4": 3, 4, 5 e 6mm
- S10H2 4 Bits caixa fenda 1/4": 3, 4, 5, 5,5 e 7mm
- S11H2 4 Bits caixa phillips 1/4": PH0, PH1; PH2 e PH3
- S12H2 4 Bits caixa pozi 1/4": PZ0, PZ1, PZ2 e PZ3
- AG010184C 1 Punho flexível 1/4" com caixa 7mm
- AG010184D 1 Punho flexível 1/4" com caixa 8mm
- 1 Punho flexível de 1/4" com caixa

A



S29H4141KV

104.70€

Tabuleiro com 41 peças, jogo de bits (1/3 de gaveta)

Composição:

- Bits hexagonais
- Bits torx
- Bits estriados
- Porta bits 1/2"
- Porta bits 3/8"
- Chave para molas de travão

A



Tabuleiros de ferramenta para carros
Tabuleiros em espuma de alta densidade EVA
W25106KV
45.30€

Tabuleiro com 6 chaves de bocas (1/3 de gaveta)

Composição:

W25 6x7; 8x9; 10x11; 12x13; 14x15 e 16x17

A

W25107KV
105.90€

Tabuleiro com 7 chaves de bocas (2/3 de gaveta)

Composição:

W25 18-19; 20-22; 21-23; 24-26; 25-28; 27-30 e 30-32mm

B

W25110KV
88.10€

Tabuleiro com 10 chaves de bocas (1/3 de gaveta)

Composição:

W25 6x7; 8x9; 10x11; 12x13; 14x15; 16x17; 18x19; 21x23; 24x27 e 30x32

A

W26108KV
107.60€

Tabuleiro com 8 chaves mistas (2/3 de gaveta)

Composição:

W26 18; 19; 21; 22; 24; 27; 30 e 32mm

B

W26110KV
60.80€

Tabuleiro com 10 chaves mistas (1/3 de gaveta)

Composição:

W26 6; 7; 8; 10; 11; 12; 13; 14; 16 e 17mm

A

W26116KV
95.90€

Tabuleiro com 16 chaves mistas - boca/ luneta (1/3 de gaveta)

Composição:

W26 6; 7; 8; 9; 10; 11; 12; 13; 14; 15; 16; 17; 18; 19; 22 e 24mm

A

W65105KV
51.20€

Tabuleiro com 5 chaves curva luneta (1/3 de gaveta)

Composição:

8x10; 10x12; 13x15; 14x17 e 19x22mm

A

AG10002SC

81.00€

Jogo de machos e caçonetes

Composição:

- Machos M3 a M12
- Caçonetes M3 a M12
- Porta caçonetes
- Desandador de machos



D376514SC

50.90€

Jogo de chaves de precisão

Composição:

- Phillips: PH00; PH0 e PH1
- Fenda: 2; 2,4 e 3mm
- Torx: T5; T6; T7; T8; T9; T10; T15 e T20



P0813SC

63.00€

Jogo de alicates

Composição:

- P087** Alicate universal
- P097** Alicate de corte
- P118** Alicate de pontas



R4811SC

87.00€

Jogo de chaves de caixa de 1/4" e 3/8"

Composição/ medidas em mm:

- Roquete de 1/4" de 72 dentes
- Roquete de 3/8" de 72 dentes
- Extensão de 3/8": 75
- Extensão de 3/8": 250
- Extensão de 1/4": 50
- Extensão de 1/4": 150
- Cardan de 1/4"
- Cardan de 3/8"
- Adaptador 1/4" - 3/8"
- Adaptador 3/8" - 1/2"
- Punho



S04H5129SC

69.20€

Jogo de chaves de caixa sextavadas de 1/4 e 3/8" com 28 peças

Composição/ medidas em mm:

- Chaves de caixa de 1/4": 4; 4,4; 5; 5,5; 6; 7; 8; 9; 10; 11; 12 e 13
- Chaves de caixa longa: 8; 10; 12 e 13
- Chaves de caixa 3/8": 14; 15; 17; 18; 19; 20; 22 e 24
- Chaves de caixa longa: 14; 15 e 17
- Chaves de velas 3/8": 16 e 21



V11011SC

57.70€

Jogo com alicata de cravar fêmeas

Composição/ medidas em mm:

- Alicata de cravar
- Bicos M3 a M6



W25117SC

77.40€

Jogo de chaves bocas e hexagonais

Composição/ medidas em mm:

- Chaves de bocas: 8x9; 10x11; 12x13; 14x15; 16x17; 18x19; 20x22 e 24x27
- Chaves hexagonais: 1,2; 2; 2,5; 3; 4; 5; 6; 8 e 10



W27AT02SC

68.80€

Jogo de alicates

Composição/ medidas em mm:

- P32M10C** Alicata de pressão
- W27AT10** Chave ajustável



Tabuleiros em espuma EVA aplicáveis aos carros: C-4DW, C-6DW e C-7D

P-EVA(D70105KV) 13.40€



P-EVA(D71PP08KV) 13.70€



P-EVA(D737128SV) 39.80€



P-EVA(D737134SV) 39.90€

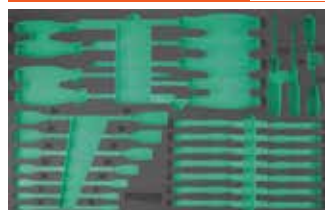

P-EVA(H10MB08KV) 13.40€



P-EVA(H10MT08KV) 13.40€



P-EVA(H10121SV) 39.90€



P-EVA(P82736SV) 40.50€



P-EVA(M09103KV) 13.40€



P-EVA(M63113KV) 13.40€

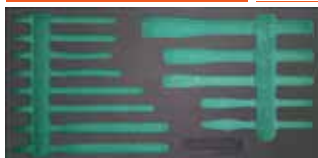

P-EVA(MHS08KV) 25.30€



P-EVA(P011804KV) 13.40€



P-EVA(P32M105KV) 13.40€



P-EVA(P82714SV) 39.90€



Tabuleiros de ferramenta vazios

Tabuleiros em espuma EVA aplicáveis aos carros: C-4DW, C-6DW e C-7D

P-EVA(S03A4122KV)

13.40€



P-EVA(S04H2132KV)

13.40€



P-EVA(S04H4144KV)

14.30€



P-EVA(S04H4295SV)

39.40€

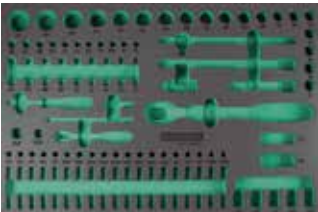

P-EVA(S04H42165SV)

39.40€



P-EVA(S04H45121SV)

39.50€

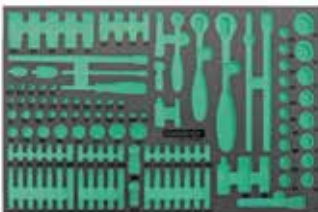

P-EVA(S07H2138KV)

15.50€



P-EVA(S29H4141KV)

13.40€



P-EVA(W23559SV)

39.90€



P-EVA(W25110KV)

13.50€

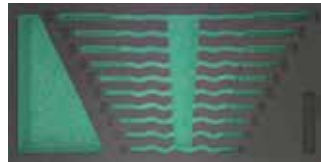

P-EVA(W26116KV)

13.40€

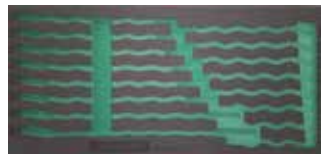

P-EVA(W26134SV)

41.70€

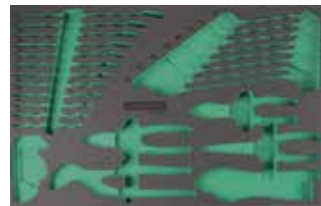

P-EVA(W2623431SV)

38.30€



P-B (31) 7.90€

Medidas:

425x185x52mm

B



P-B (41) 6.10€

Medidas:

375x144,5x52mm

A



Tabuleiros de ferramenta vazios para composições

aplicáveis aos carros: C-4DW, C-6DW e C-7DW

P-TR(AG010002SP)	3.20€
P-TR(AG010026SP)	3.20€
P-TR(AI10002SP)	3.50€
P-TR(D70105SP)	2.90€
P-TR(D71PP08SP)	2.70€
P-TR(H10MB08SP)	3.30€
P-TR(M09513SP)	3.00€
P-TR(M645114SP)	3.20€
P-TR(P018SP)	3.00€
P-TR(P04704SP)	3.20€
P-TR(P0803SP)	3.00€
P-TR(P0903SP)	3.20€
P-TR(P2710SP)	3.20€
P-TR(S03A4122SP)	3.20€
P-TR(S04H2125SP)	3.30€
P-TR(S04H3157SP)	4.80€
P-TR(S04H3536SP)	4.00€
P-TR(S04H4125SP)	4.80€
P-TR(S04H4524SP)	2.90€
P-TR(S04H4726SP)	3.90€
P-TR(S04H4728SP)	3.80€
P-TR(S06H427SP)	2.90€
P-TR(S09H4118SP)	3.20€
P-TR(S29H4140SP)	3.80€
P-TR(W23108SP)	3.30€
P-TR(W25110SP)	2.90€
P-TR(W26112SP)	3.00€
P-TR(W26116SP)	3.20€



Tabuleiros de ferramenta vazios para composições

aplicáveis à mala: C-3DH2

P-TR (D70SP06ST) 2.00€

Para chaves D70



P-TR (PC303ST) 2.00€

Para alicates: P087; P106 e P118



P-TR (S04H4120ST) 2.40€

Para chaves de caixa de 1/2" com roquete



P-TR (S04H4506ST) 2.30€

Para extensões



P-TR (W26107ST) 2.30€

Para chaves mistas W26



P-TR (W26920ST) 2.00€

Para chaves mistas W26 e chaves hexagonais



T10H1210S

379.80€

Jogo de chave dinamométrica com 7 chaves intermutáveis 14x18

Torque: 40-210 Nm



T103

Chave "Pata de Galo" 14x18

Ref.	Medida (mm)	Preço
T31313	13	19.60€
T10314	14	15.10€
T10315	15	15.10€
T10316	16	15.10€
T10317	17	14.40€
T10318	18	14.40€
T10319	19	14.40€
T10321	21	14.40€
T10322	22	14.40€
T31324	24	22.70€
T31332	32	21.50€



T290

Cabeçote para chave dinamométrica de cabeças intermutáveis

Ref.	Quadra	Medida (mm)	Preço
T29002	1/4"	14/18	25.00€
T29014	1/2"	14/18	31.00€
T29016	3/4"	14/18	35.80€



T21

Chave dinamométrica com precisão de: +/- 3%

Ref.	Quadra	Torque (Nm)	Comp. (mm)	Preço
T21025N	1/4"	5-25	320	135.40€
T21050N	3/8"	10-50	390	141.60€
T211000N	1"	200-1 000	1 510	749.90€
T21101N	1/2"	20-100	390	159.80€
T21200N	1/2"	40-200	502	162.00€
T21340N	1/2"	60-340	604	190.40€
T21341N	3/4"	60-340	604	199.40€
T21550N	3/4"	110-550	938	443.10€



T25

Chave dinamométrica com precisão de: +/- 4%

Ref.	Quadra	Torque (Nm)	Comp. (mm)	Preço
T25100N	3/8"	20-100	390	117.30€
T25200N	1/2"	40-200	502	123.70€
T25340N	1/2"	60-340	604	159.30€



T27

Chave dinamométrica com precisão de: +/- 4%

Ref.	Quadra	Torque (Nm)	Comp. (mm)	Preço
T27010N	1/4"	2-10	308	83.30€
T27020N	1/4"	4-20	340	89.10€
T27021N	3/8"	4-20	340	84.30€
T27060N	3/8"	10-60	340	93.00€
T271001N	1"	200-1 000	1 177	616.40€
T27101N	1/2"	20-100	458	100.10€
T27200N	1/2"	40-200	531	106.00€
T27340N	1/2"	60-340	585	114.20€
T27800N	3/4"	150-800	1 177	495.90€



T47

Chave dinamométrica com precisão de: +/- 4%

Ref.	Quadra	Torque (Nm)	Comp. (mm)	Preço
T47010N	1/4"	2-10	340	95.70€
T47020N	1/4"	4-20	370	95.70€
T47021N	3/8"	4-20	370	96.40€
T47060N	3/8"	10-60	370	102.40€
T47101N	1/2"	200-100	464	108.90€
T47200N	1/2"	40-200	530	119.10€
T47340N	1/2"	60-340	585	129.20€



Novo

T30200NS

309.20€

Barra dinamométrica com conjunto de 9 ponteiros de bocas -

Precisão 4%

Composição:

Torque: 40-200 Nm

Cabeçote 1/2"

Encaixe: 14x18mm

Ponteiras: 13; 14; 15; 17; 19; 22; 24; 27 e 30mm



T33

Chave dinamométrica reversível

Precisão: sentido horário: 5%
sentido anti-horário: 6%

Ref.	Quadra	Torque (Nm)	Preço
T33025N	1/4"	5-25	129.10€
T33050N	3/8"	10-50	143.30€
T33101N	1/2"	20-100	145.10€
T33200N	1/2"	40-200	152.90€
T33341N	3/4"	60-340	190.30€

T41

Chave dinamométrica

Ref.	Quadra	Medida (nm)	Preço
T41200N	1/2"	40-200	178.40€
T41340N	1/2"	60-340	213.00€

T41-SK
33.50€
Medidor angular p/T41 e T21
200/340Nm

T14200N
288.60€
Chave dinamométrica digital intermutável com precisão de: +/- 1%

Capacidade: 20-200Nm
Comprimento: 550mm
Peso: 1 150g
Cabeçote: 14x18

Memória: 10 leituras
Unidade: Nm; fb-lb; Kg-m; in-lb
Pilhas: 3x1,5v AA (não incluídas)

T24135
390.00€
Chave dinamométrica digital reversível com aperto à esquerda e à direita

Precisão de: +/- 2% à direita | +/- 3% à esquerda

Torque: 6,8-135Nm

Quadra: 3/8"

T24200
378.90€
Chave dinamométrica digital com aperto à esquerda e à direita
Precisão de: +/- 2% à direita | +/- 3% à esquerda

Capacidade: 10-200Nm
Comprimento: 530mm
Quadra: 1/2"

Memória: 50 leituras
Unidade: Nm; fb-lb; Kg-cm; in-lb

T19
Medidor digital de torque com precisão de: +/- 2%

Com aviso luminoso e sonoro

Ref.	Quadra	Torque (Nm)	Preço
T19135N	3/8"	10-135	80.90€
T19200N	1/2"	20-200	83.80€

T19600N
316.70€
Medidor digital de torque

Quadra: 3/4"
Torque: 60-600 Nm

R12
Roquete reversível de 60 dentes

Ref.	Quadra	Comp. (mm)	Preço
R1206N	3/4"	500	77.90€
R12081	1"	675	157.90€



T

Kits de reparação para chaves dinâmicas

Ref.	Aplicáveis aos modelos	Preço
T04M060-R	T04M060	9.30€
T04M061-R	T04M061	9.60€
T04M150-R	T04M150	12.00€
T04M250-R	T04M250	16.20€
T07030N-R	T07030N	8.60€
T07110N-R	T07110N	9.30€
T07700N-R	T07700N	70.60€
T102001S-R	T102001S	14.90€
T154100N-R	T154100N	12.00€
T154200N-R	T154200N	17.80€
T16005N-R	T16005N	9.80€
T21025N-R	T21025N	12.90€
T21050N-R	T21050N	13.70€
T211000N-R	T211000N	76.10€
T21101N-R	T21101N	17.30€
T21200N-R	T21200N	15.90€
T21340N-R	T21340N	16.90€
T21341N-R	T21341N	53.60€
T21550N-R	T21550N	53.60€
T24135-R	T24135	25.00€
T24200-R	T24200	28.60€
T25100N-R	T25100N	13.70€
T25200N-R	T25200N	15.40€
T25340N-R	T25340N	14.90€
T27-D2R	T27010N, T27020N, T27030N	9.20€
T27-D3R	T27021N, T27031N, T27060N, T27100N	9.80€
T27-D4R1	T27101N	11.50€
T27-D4R2	T27200N, T27340N	13.00€
T27-D6R	T27500N, T27600N, T27800N, T271000N	32.70€
T27-D8R	T27801N, T271001N	55.30€
T33025N-R	T33025N	13.10€
T33050N-R	T33050N	15.50€
T33101N-R	T33101N	15.80€
T33200N-R	T33200N	16.30€
T33341N-R	T33341N	18.50€
T41200N-R	T41200N	12.50€
T41340N-R	T41340N	12.60€

R29

Roquete reversível de 36 dentes

Ref.	Quadra	Comp. (mm)	Preço
R2902	1/4"	146	15.30€
R2904	1/2"	278	24.50€



R34

Roquete de 72 dentes com punho antideslizante

Ref.	Quadra	Comp. (mm)	Torque (Nm)	Preço
R3403	3/8"	196	245	25.70€



R35

Roquete de 72 dentes com punho antideslizante

Ref.	Quadra	Comp. (mm)	Torque (Nm)	Preço
R3502	1/4"	135	68	19.80€
R3503	3/8"	199	245	25.00€
R3504	1/2"	250	647	29.80€



R36

Roquete metálico reversível de 48 dentes

Ref.	Quadra	Comp. (mm)	Torque (Nm)	Preço
R3602	1/4"	128	68	20.10€
R3603	3/8"	198	245	22.60€



R37

Roquete reversível de 48 dentes com punho antideslizante

Ref.	Quadra	Comp. (mm)	Torque (Nm)	Preço
R3702	1/4"	135	68	19.90€
R3703	3/8"	198	245	25.00€
R3704	1/2"	353	647	28.90€



R37B

Roquete reversível curto de 48 dentes com punho antideslizante

Ref.	Quadra	Comp. (mm)	Torque (Nm)	Preço
R3702B	1/4"	110	68	19.20€
R3704B	1/2"	180	647	25.70€



R41

Roquete reversível e articulado de 36 dentes com punho antideslizante

Ref.	Quadra	Comp. (mm)	Preço
R4103	3/8"	238	24.40€
R4104	1/2"	288	30.40€



R45

Roquete reversível e rotativo de 48 dentes



Ref.	Quadra	Comp. (mm)	Preço
R4502	1/4"	185	42.00€

R46

Roquete 48 dentes longo



Ref.	Quadra	Preço
R4602	1/4"	27.40€
R4603	3/8"	31.90€
R4604	1/2"	38.70€

R48

Roquete reversível de 72 dentes



Ref.	Quadra	Comp. (mm)	Preço
R4802	1/4"	146	16.50€
R4803	3/8"	185	18.80€
R4804	1/2"	278	24.50€

R48

Roquete metálico reversível de 72 dentes



Ref.	Quadra	Comp. (mm)	Preço
R4802A	1/4"	125	14.60€
R4804A	1/2"	250	23.30€

R48

Roquete curto reversível de 72 dentes



Ref.	Quadra	Comp. (mm)	Peso (g)	Preço
R4802B	1/4"	110	100	15.50€
R4804B	1/2"	170	442	23.20€

R51

Roquete reversível e extensível de 72 dentes com punho antideslizante



Ref.	Quadra	Comp. (mm)	Peso (g)	Preço
R5103	3/8"	220-230	440	25.10€
R5104	1/2"	300-400	930	30.20€

R66

Roquete com cabo rotativo de 60 dentes

Ref.	Quadra	Comp. (mm)	Peso (g)	Preço
R6602	1/4"	180	181	52.40€
R6603	3/8"	290	645	54.10€
R6604	1/2"	240	384	63.80€

R68

Roquete reversível de baixo perfil de 60 dentes



Ref.	Quadra	Peso (g)	Preço
R6802	1/4"	165	20.40€
R6803	3/8"	265	24.70€
R6804	1/2"	520	29.80€

RD01

18.20€

Mini roquete

 Quadra: 1/4"
 Dentes: 60
 Comprimento: 200mm

RD02

21.40€

Mini roquete flexível

 Quadra: 1/4"
 Dentes: 60
 Comprimento: 170mm

T094602

380.10€

Roquete desmultiplicador 1/2" - 3/4" R 1:9

Torque máximo: 1 500 Nm

T094602-RK

321.80€

Kit de reparação

T096801

443.00€

Roquete desmultiplicador 3/4" - 1" R 1:4

Torque máximo: 2 500 Nm

T096801-RK

321.30€

Kit de reparação

T351060 166.90€

Aparafusador de torque de 1 a 6Nm

Composição:

- Aparafusador: 1-6 Nm
- Adaptador 1/4"
- 4 Bits phillips: PH0; PH1; PH2 e PH3
- 4 Bits fenda: 3; 4; 5 e 6mm
- 5 Bits torx: 10; 15; 20; 25 e 30
- 6 Bits hexagonais: 1.5; 2; 3; 4; 5 e 6mm



R

Kits de reparação para roquetes



Ref.	Aplicáveis aos modelos	Preço
R1206N-R	R1206N	29.30€
R1206R	R1206	27.40€
R2902RK	R2902; R2902A; R2902B	6.70€
R2903RK	R2903; R2903A; R2903B ; R4103	7.70€
R2904RK	R2904; R2904A; R2904B ; R4104	8.70€
R3602RK	R3602; R3702; R3702B; R3802	10.10€
R3603RK	R3603; R3703; R3803	12.70€
R3604RK	R3604; R3704; R3704B; R3804	14.90€
R3402RK	R3402; R3502	10.30€
R3403RK	R3403; R3503	13.20€
R3404RK	R3404; R3504	14.70€
R4502RK	Para cabeça de roquete	9.60€
R4502JRK	Para articulação	8.60€
R4802RK	R4802	7.00€
R4804RK	R4804	8.60€
R5103RK	R5103	7.80€
R5104RK	R5104	10.10€
R5802ERK	R5802E	12.60€
R5803RK	R5803	15.50€
R5804ERK	R5804E	19.70€
R5804LRK	R5804L	19.90€
R6802RK	R68	11.60€
R6803RK	R68	15.10€
R6804RK	R68	16.00€
R12081RK	R12081	81.50€

W24A107S 120.90€

Jogo de chaves luneta aberta flexível

Composição:

- Chaves: 8x8; 10x10; 11x11; 12x12; 13x13; 14x14 e 17x17

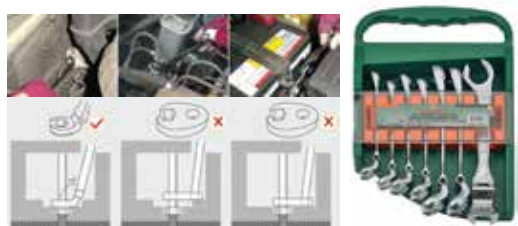

W45

Chave combinada boca/ roquete



Ref.	Medida (mm)	Comp. (mm)	Preço
W45108	8	135,40	10.50€
W45109	9	159,50	11.50€
W45110	10	159,50	11.70€
W45111	11	165,90	11.80€
W45112	12	168,60	11.90€
W45113	13	178,50	12.00€
W45114	14	190,50	12.50€
W45115	15	199,40	14.30€
W45116	16	206,40	14.50€
W45117	17	225,40	15.50€
W45118	18	236,40	17.30€
W45119	19	247,40	17.30€
W45121	21	281,00	25.60€
W45122	22	281,00	27.40€
W45124	24	281,00	29.90€
W45127	27	330,00	47.40€
W45130	30	425,00	53.40€
W45132	32	425,00	60.30€

W45110S 108.40€

Jogo de chaves de boca/ roquete de 9 peças

Composição:

- W45 Chaves: 8; 10; 12; 13; 17 e 19mm
- Adaptadores 1/4"; 3/8" e 1/2"
- Porta bits



W45117S 391.90€

Jogo de chaves combinadas boca/ roquete com 72 dentes de 17 peças

Composição:

- W45 Chaves: 8; 10; 12; 13; 14; 17; 19; 21; 22; 24; 27; 30 e 32mm
- Adaptadores 1/4"; 3/8"; 1/2" e 3/4"
- Porta bits
- Mala



W45316S

178.70€

Jogo de chaves combinadas boca/ roquete com 72 dentes de 16 peças

Composição:

W45 Chaves: 8 a 19mm
Adaptadores 1/4"; 3/8" e 1/2"
Porta bits
Mala



W45316S-AD

18.50€

Conjunto de 4 adaptadores

Composição:

Adaptadores 1/4"; 3/8" e 1/2"
Porta bits



W45316S-AD12

6.60€

Adaptador 1/2" para chave 19mm



W45316S-AD14

4.70€

Adaptador 1/4" para chave 10mm



W45316S-AD34

17.90€

Adaptador 3/4" para chave 32mm



W45316S-AD38

5.40€

Adaptador 3/8" para chave 13mm



W45316S-ADBH14

2.10€

Porta bits 1/4" para chave 10mm



W51110S

136.00€

Jogo de 10 chaves curtas boca/ roquete

Composição:

W51 Chaves: 8; 10; 11; 12; 13; 14; 15; 16; 17 e 19mm



W52105S

100.30€

Jogo de 5 chaves curtas boca/ roquete flexível

Composição:

W52 Chaves: 8; 10; 12; 14 e 17mm



W66107S

136.00€

Jogo de 7 chaves de boca/ roquete flexível

Composição:

W66 Chaves: 8; 10; 11; 13; 14; 17 e 19mm



W66116S

264.90€

Jogo de chaves combinadas boca/ roquete flexível de 72 dentes com 16 peças

Composição:

W66 Chaves: 8 a 19mm
Adaptadores 1/4"; 3/8" e 1/2"
Suporte de bit
Mala



W66

Chave de boca/ roquete flexível

Ref.	Medida (mm)	Comp. (mm)	Preço
W66108	8	137	17.90€
W66109	9	159	17.90€
W66110	10	159	17.90€
W66111	11	175	19.10€
W66112	12	175	19.10€
W66113	13	186	19.90€
W66114	14	194	20.90€
W66115	15	216	22.40€
W66116	16	216	25.00€
W66117	17	232	25.00€
W66118	18	250	25.60€
W66119	19	250	25.60€
W66121	21	250	37.60€
W66124	24		45.60€



W67104S

75.40€

Jogo de chaves luneta (torx) com roquete

Composição:

Chaves: E6xE8; E10xE12; E14xE18 e E20xE24mm



W68

Chave roquete de 72 dentes

Ref.	Medida (mm)	Preço
W680809	8x9	17.30€
W680810	8x10	17.30€
W681011	10x11	17.60€
W681213	12x13	18.20€
W681415	14x15	22.00€
W681618	16x18	22.70€
W681719	17x19	25.10€



W68106S

109.50€

Jogo de chaves roquete de 72 dentes com 6 peças

Composição:

W68 Chaves: 8x9; 10x11; 12x13; 14x15; 16x18 e 17x19



W73

Chave 4 em 1 com roquete

Ref.	Medida (mm)	Preço
W7310813	8x10 12x13	27.20€
W7311419	14x17 18x19	31.00€



W73102S

56.50€

Jogo de chaves com roquete 4 em 1

Podendo ser utilizadas em 4 medidas

Composição/ medidas em mm:

Chave 8x10 - 12x13
Chave 14x17 - 18x19



W91107S

104.70€

Jogo de chaves combinadas boca especial/ roquete de 72 dentes

Composição:

Chaves: 10; 12; 13; 14; 15; 17 e 19mm



W91

Chave boca especial/ luneta com roquete

Ref.	Medida (mm)	Comp. (mm)	Preço
W91110	10	159,5	12.00€
W91112	12	168,6	12.30€
W91113	13	178,5	12.80€
W91114	14	190,5	14.10€
W91115	15	199,4	16.10€
W91117	17	225,4	17.90€
W91119	19	247,4	17.70€

W93108S
144.90€
Jogo de chaves mistas com roquete reversível e anel de retenção

Composição:

Chaves: 10; 11; 12; 13; 14; 15; 17 e 19mm

W93

Chave mista boca roquete com anel retenção

Ref.	Medida (mm)	Comp. (mm)	Preço
W93110	10	158	14.70€
W93111	11	164	16.50€
W93112	12	167	17.70€
W93113	13	177	17.70€
W93114	14	189,4	19.40€
W93115	15	198	20.70€
W93117	17	224	23.90€
W93119	19	245	26.90€

W61

Chave luneta longa

Ref.	Medida (mm)	Comp. (mm)	Preço
W611011	10x11	295	12.00€
W611214	12x14	330	14.20€
W611315	13x15	370	17.80€
W611618	16x18	405	19.80€
W611719	17x19	405	20.10€
W612224	22x24	435	30.00€

W61106S
130.30€
Jogo de 6 chaves luneta longas

Fornecido em bolsa plástica com divisórias

Composição:

Medida	Comp. (mm)
10x11	235
12x14	330
13x15	370
16x18	405
17x19	405
22x24	435

W62

Chave luneta direita

Ref.	Medida (mm)	Comp. (mm)	Preço
W6210607	6x7	120	4.80€
W6210809	8x9	135	5.20€
W6211011	10x11	150	6.00€
W6211213	12x13	165	6.50€
W6211415	14x15	210	7.10€
W6211617	16x17	210	7.90€
W6211819	18x19	225	8.50€
W6212022	20x22	240	9.50€
W6212427	24x27	270	16.30€
W6212528	25x28	285	18.00€
W6213032	30x32	335	20.20€

W62108S
65.00€
Jogo de 8 chaves luneta direita

Composição:

W62 Chaves: 6x7; 8x9; 10x11; 12x13; 14x15; 16x17; 18x19 e 20x22mm

W23108S
71.50€
Jogo de 8 chaves luneta 75°

Fornecido em bolsa plástica com divisórias

Composição:

W23 Chaves: 6x7; 8x9; 10x11; 12x13; 14x15; 16x17; 18x19 e 20x22mm

W23

Chave luneta 75°



Ref.	Medida (mm)	Comp. (mm)	Preço
W230607	6x7	168	4.60€
W230809	8x9	183	5.10€
W230810	8x10	183	6.20€
W231011	10x11	198	6.30€
W231113	11x13	217	6.60€
W231213	12x13	217	7.00€
W231317	13x17	217	8.90€
W231415	14x15	239	8.90€
W231617	16x17	260	8.90€
W231719	17x19	292	8.90€
W231819	18x19	292	9.60€
W231922	19x22	318	11.40€
W232022	20x22	318	12.40€
W232123	21x23	327	13.10€
W232224	22x24	327	14.00€
W232426	24x26	329	15.70€
W232427	24x27	329	16.10€
W232528	25x28	347	16.90€
W233032	30x32	362	19.40€



W24

Chave luneta aberta



Ref.	Medida (mm)	Faces	Comp. (mm)	Preço
W240809	8x9	6	145	4.00€
W241011	10x11	6	152	4.30€
W241012	10x12	6	152	4.40€
W241213	12x13	6	165	5.00€
W241214	12x14	6	178	5.60€
W241314	13x14	6	178	5.60€
W241417	14x17	6	196	6.70€
W241617	16x17	12	196	7.50€
W241719	17x19	12	210	8.30€
W241819	18x19	12	210	8.60€
W241922	19x22	12	233	10.80€
W242224	22x24	12	252	12.40€
W242427	24x27	12	265	15.80€
W242528	25x28	12	265	17.50€
W243032	30x32	12	285	17.50€

W24N

Chave luneta aberta com batente



Ref.	Medida (mm)	Comp. (mm)	Preço
W24N0810	8x10	122	9.20€
W24N1113	11x13	143	10.70€
W24N1214	12x14	145	11.00€
W24N1719	17x19	162	15.50€

W24106S

42.80€

Jogo de 6 chaves luneta aberta

Fornecido em bolsa plástica com divisórias

Composição:

W24 Chaves: 8x9; 10x11; 10x12; 13x14; 16x17 e 17x19mm



W25

Chave de bocas



Ref.	Medida (mm)	Comp. (mm)	Preço
W250607	6x7	123	2.90€
W250608	6x8	123	3.00€
W250809	8x9	140	3.10€
W251011	10x11	156	3.50€
W251012	10x12	156	3.70€
W251213	12x13	172	4.10€
W251214	12x14	180	4.10€
W251415	14x15	190	4.20€
W251417	14x17	195	5.20€
W251617	16x17	205	5.50€
W251618	16x18	205	6.10€
W251719	17x19	221	6.40€
W251819	18x19	221	6.60€
W251922	19x22	237	7.50€
W252022	20x22	237	7.40€
W252123	21x23	247	8.60€
W252224	22x24	247	8.60€
W252426	24x26	263	9.60€
W252427	24x27	263	10.20€
W252528	25x28	279	12.50€
W252730	27x30	283	12.90€
W252732	27x32	289	14.00€
W253032	30x32	298	14.00€
W253236	32x36	330	26.00€
W253641	36x41	380	32.60€
W253842	38x42	380	34.80€
W254146	41x46	415	50.80€
W254650	46x50	430	68.60€

W25108S

46.50€

Jogo de 8 chaves de bocas

Fornecido em bolsa plástica com divisórias

Composição:

W25 Chaves: 6x7; 8x9; 10x11; 12x13; 14x15; 16x17; 18x19 e 20x22mm



W26
Chave de bocas/ luneta

Ref.	Medida (mm)	Preço
W26106	6	2.60€
W26107	7	2.80€
W26108	8	3.00€
W26109	9	3.00€
W26110	10	3.20€
W26111	11	3.40€
W26112	12	3.60€
W26113	13	3.80€
W26114	14	3.90€
W26115	15	4.70€
W26116	16	4.80€
W26117	17	5.70€
W26118	18	5.80€
W26119	19	6.40€
W26120	20	7.60€
W26121	21	8.20€
W26122	22	8.40€
W26123	23	9.40€
W26124	24	9.20€
W26125	25	10.00€
W26126	26	11.40€
W26127	27	11.30€
W26128	28	12.30€
W26129	29	13.10€
W26130	30	14.00€
W26132	32	15.40€
W26134	34	27.10€
W26136	36	34.20€
W26138	38	44.90€
W26141	41	49.60€
W26142	42	49.60€
W26144	44	66.30€
W26146	46	68.20€
W26148	48	84.60€
W26150	50	88.60€
W26155	55	143.20€
W26160	60	184.60€
W26165	65	244.10€

W26
Jogo de chaves de boca/ luneta

Fornecido em bolsa plástica com divisórias

Ref.	Chaves	Medida (mm)	Preço
W26112S	12xW26	8 a 17; 19 e 22	69.50€
W26114S	14xW26	10 a 14; 16; 17; 19; 21; 22; 24; 27; 30 e 32	116.10€
W26126S	26xW26	6 a 32	214.70€

W26411PRS

77.00€

Jogo de 11 chaves mistas longas

Fornecido em bolsa plástica com divisórias

Composição:

W264 Chaves: 7; 8; 9; 10; 11; 12; 13; 14; 15; 17 e 19mm

W26414S

180.80€

Jogo de 14 chaves mistas boca/ luneta SAE

Fornecido em bolsa plástica com divisórias

Composição:

W26 Chaves: 3/8"; 7/16"; 1/2"; 9/16"; 5/8"; 11/16"; 13/16"; 7/8"; 15/16"; 1"; 1-1/16"; 1-1/8"; 1-1/4"

W29
Chave luneta para parafusos torx

Ref.	Medida	Comp. (mm)	Preço
W290608	E6xE8	112	7.50€
W290711	E7xE11	125	9.10€
W291012	E10xE12	140	9.10€
W291418	E14xE18	180	9.30€
W291622	E16xE22	200	9.60€
W292024	E20xE24	224	9.80€

W39
Chave de bocas de perfil fino

Ref.	Medida (mm)	Comp. (mm)	Preço
W391011	10x11	175	6.20€
W391213	12x13	210	7.70€
W391415	14x15	210	8.00€
W391617	16x17	250	11.30€
W391819	18x19	250	11.70€

W39108SA

85.20€

Jogo de 8 chaves de bocas de perfil fino

Composição:

W39 Chaves: 6x7; 8x9; 10x11; 12x13; 14x15; 16x17; 18x19 e 20x22mm

W69116S

174.50€

Jogo de 16 chaves mistas 75°

Composição:

W69 Chaves: 7; 8; 9; 10; 11; 12; 13; 14; 15; 16; 17; 18; 19; 21; 22 e 24mm



S57

Chaves de cachimbo

Ref.	Medida (mm)	Preço
S57H108	8	10.40€
S57H109	9	11.40€
S57H110	10	12.10€
S57H111	11	12.50€
S57H112	12	14.60€
S57H113	13	19.10€
S57H115	15	18.70€
S57H116	16	18.70€
S57H117	17	22.20€
S57H118	18	22.20€
S57H119	19	22.20€
S57H121	21	31.50€
S57H122	22	40.50€
S57H123	23	40.50€
S57H124	24	44.60€
S57H125	25	45.20€
S57H127	27	58.40€
S57H132	32	76.40€



S57H108S

135.80€

Jogo de 8 chaves de cachimbo

Fornecido em bolsa plástica com divisórias

Composição:

S57 Chaves: 8; 10; 11; 13; 16; 17; 18 e 19mm



W65

Chave curva luneta para motores de arranque

Ref.	Medida (mm)	Preço
W6510810	8x10	4.40€
W6511012	10x12	5.20€
W6511315	13x15	5.90€
W6511417	14x17	7.10€
W6511922	19x22	9.10€



W65A

Chave curva luneta

Ref.	Medida	Comp. (mm)	Preço
W65A1012	10x12	141	9.20€
W65A1214	12x14	166	12.30€
W65A1315	13x15	190	15.10€
W65A1618	16x18	220	16.60€
W65A1719	17x19	220	17.80€
W65A1922	19x22	256	21.50€
W65A2224	22x24		26.20€



W65A105S

79.50€

Jogo de 5 chaves curvas luneta

Composição:

W65A Chaves: 10x12; 12x14; 13x15; 16x18 e 17x19mm



W43A

Chave de caixa flexível

Ref.	Medida (mm)	Comp. (mm)	Preço
W43A0607	6x7	180	6.70€
W43A0809	8x9	180	6.80€
W43A1011	10x11	202	7.10€
W43A1213	12x13	222	8.60€
W43A1415	14x15	245	9.40€
W43A1617	16x17	260	11.30€
W43A1819	18x19	280	14.30€



W43A106S

63.50€

Jogo de 6 chaves de caixa flexíveis

Composição:

W43A Chaves: 8x9; 10x11; 12x13; 14x15; 16x17 e 18x19mm
Mala





W77A

Chave luneta 70° para extensão

Utiliza extensão da série W77H

Ref.	Medida (mm)	Comp. (mm)	Preço
W77A124	24	180	24.10€
W77A127	27	190	27.80€
W77A132	32	235	37.80€
W77A136	36	245	44.90€
W77A138	38	245	46.50€
W77A141	41	265	54.70€
W77A146	46	280	64.90€
W77A150	50	290	67.30€
W77A155	55	300	94.80€
W77A160	60	345	125.50€
W77A165	65	355	151.90€

W77H

Extensão para chave W77A

Utilizável em conjunto com as chaves da série W77A

Ref.	Medida (mm)	Utilizar em (mm)	Preço
W77H01	480	24~30	29.70€
W77H02	610	32~41	46.40€
W77H03	760	46~55	80.90€
W77H04	860	60~65	102.40€

WFS46

38.90€

Chave para filtro diferencial

Inclui chave hexagonal de 5mm

Medida: 46mm

Estriado de 12 faces

Aplicação: VW: Bora, Golf IV, Sharan

Skoda: Octavia



W67

Chave de boca pancada

Ref.	Medida (mm)	Comp. (mm)	Preço
W67119	19	177	7.30€
W67121	21	177	7.10€
W67124	24	197	8.60€
W67130	30	243	14.00€
W67132	32	273	18.10€
W67136	36	299	27.40€
W67138	38	299	29.20€
W67141	41	339	36.90€
W67145	45	374	42.30€
W67146	46	374	42.30€
W67150	50	417	58.00€
W67155	55	496	84.50€
W67160	60	496	84.50€
W67165	65	496	84.50€
W67170	70	496	145.10€



Ferramenta de aperto

W72

Chave de luneta pancada

Ref.	Medida (mm)	Comp. (mm)	Preço
W72117	17	160	10.80€
W72118	18	160	10.80€
W72119	19	160	11.00€
W72121	21	160	11.00€
W72122	22	163	11.30€
W72124	24	163	11.30€
W72127	27	180	13.10€
W72130	30	190	17.30€
W72132	32	190	18.00€
W72134	34	205	24.70€
W72136	36	205	24.80€
W72141	41	230	33.30€
W72146	46	240	42.80€
W72150	50	255	51.70€
W72155	55	360	73.80€
W72170	70	335	173.10€



W27AR

Chave inglesa

Ref.	Abertura (mm)	Comp. (mm)	Preço
W27AR8	26,9	200	34.00€
W27AR10	34	250	42.80€



ON: funciona como roquete

OFF: funciona como chave inglesa



W27AS

Chave inglesa

Ref.	Abertura (mm)	Comp. (mm)	Preço
W27AS8	20	150	18.40€
W27AS10	29	250	21.50€
W27AS15	43	380	55.20€
W27AS18	53	450	96.60€



W27AT

Chave ajustável com cabo antideslizante

Ref.	Medida (mm)	Comp. (mm)	Preço
W27AT8	24	200	26.30€
W27AT10	29	250	30.90€
W27AT12	34	300	36.90€
W27AT15	43	375	71.40€



Ferramenta SUPERTECH

W27AL

Chave inglesa

Maior capacidade de abertura, mais fina e mais leve



Ref.	Medida (mm)	Abertura (mm)	Peso (mm)	Comprimento (mm)	Preço
W27AL10	250	43	277	256	37.50€

W27AK8

39.90€

Chave inglesa duplo sistema (métrico/SAE)

Comprimento: 200mm



W28HD

Chave bico de falcão para tubos

Ref.	Abertura (mm)	Comp. (mm)	Preço
W28HD8	10-22	200	36.10€



W28

Chave para tubos

Ref.	Abertura (mm)	Comp. (mm)	Preço
W2808	25,5	200	20.80€
W2810	38	250	23.20€
W2812	51	300	32.90€
W2814	51	350	37.70€
W2818	63,5	450	52.60€
W2824	76	600	89.80€
W2836	127	900	197.30€



W28RJ-HL

Garras de substituição

Ref.	Aplicável modelo	Preço
W2810RJ-HL	W2810	7.30€
W2812RJ-HL	W2812	8.70€
W2814RJ-HL	W2814	9.50€
W2818RJ-HL	W2818	12.90€
W2824RJ-HL	W2824	19.90€
W2836RJ-HL	W2836	41.60€



S68H2141S

72.80€

Jogo de 41 peças de 1/4" SUPERTECH

Composição/ medidas em mm:

- R2902
- Roquete de 36 dentes
 - Chaves caixa: 4; 4,5; 5; 5,5; 6; 7; 8; 9; 10; 11; 12; 13 e 14
 - Chaves hexagonais: 1,5; 2 e 2,5
 - 20 Bits
 - Extensão de 50
 - Cabo "T" corrediço
 - Adaptador hexagonal
 - Punho



S68H4127S

161.80€

Jogo de 27 peças de 1/2" SUPERTECH

Composição/ medidas em mm:

- R2904
- Roquete de 36 dentes
 - Chaves caixa: 8 a 24; 27; 30 e 32
 - Chaves de velas: 16 e 21
 - Cardan
 - Extensão de 125 e 250
 - Cabo "T" corrediço





S68H

Chave de caixa 1/4" SUPERTECH

Ref.	Medida (mm)	SAE	Torx	Preço
S68H2103	3	1/8"	E4	0.95€
S68H2104	4	5/32"	E5	0.95€
S68H21045	4,5			0.95€
S68H2105	5	3/16"	E6	0.95€
S68H21055	5,5	7/32"	E7	0.95€
S68H2106	6		E8	1.00€
S68H21065	6,5	1/4"	E8	1.00€
S68H2107	7	9/32"		1.00€
S68H2108	8	5/16"	E10	1.10€
S68H2109	9	11/32"	E11	1.10€
S68H2110	10	3/8"	E12	1.10€
S68H2111	11	7/16"	E14	1.10€
S68H2112	12	15/32"		1.30€
S68H2113	13	1/2"	E16	1.20€
S68H2114	14	9/16"	E18	1.60€

S68H5234111S

403.70€

Jogo de 111 peças de 1/4", 3/8" e 1/2" SUPERTECH

Composição/ medidas em mm:

- R3702 Roquete de 1/4"
- R3703 Roquete de 3/8"
- R3704 Roquete de 1/2"
- Chaves caixa de 1/4": 3,2 a 13
- Chaves caixa de 3/8": 9 a 19
- Chaves caixa de 1/2": 14 a 32
- Chaves de velas de 3/8": 14 e 18
- Chaves de velas de 1/2": 16 e 21
- Chaves hexagonais: 1,5; 2 e 2,5
- Chaves mistas boca/ luneta: 8 a 19
- Bits de 1/4" fenda/ phillips/ torx/ hexagonal/pozi
- Bits de 5/16" fenda/ phillips/ torx/ hexagonal/pozi
- Adaptador bits 5/16"
- Cardan de 1/4"; 3/8" e 1/2"
- Extensões de 1/4" com 50 e 150
- Extensões de 3/8" com 75 e 150
- Extensões de 1/2" com 125 e 250
- Adaptador "T" para extensões
- Punho



Ferramenta de aperto

Ferramenta SUPERTECH

W84108S

78.40€

Jogo de 8 chaves mistas boca/ luneta SUPERTECH

Chaves: 8; 10; 11; 12; 13; 14; 17 e 19mm



W84114S

125.00€

Jogo de 14 chaves mistas boca/ luneta SUPERTECH

Chaves: 6 a 19mm



W84

Chave mista boca/ luneta SUPERTECH

Ref.	Medida (mm)	Preço
W84106	6	4.90€
W84107	7	5.00€
W84108	8	5.20€
W84109	9	5.40€
W84110	10	5.70€
W84111	11	6.10€
W84112	12	6.60€
W84113	13	7.10€
W84114	14	7.50€
W84115	15	8.50€
W84116	16	9.10€
W84117	17	10.00€
W84118	18	10.80€
W84119	19	11.80€

W86112S

281.30€

Jogo de 12 chaves boca/ roquete SUPERTECH

Chaves: 8 a 19mm



S03H2327S

79.40€

Jogo de chaves e bits de caixa de 1/4" com 27 peças

Composição/ medidas em mm:

- Chave mista boca/roquete
- Mini chaves 13mm: 4; 4,5; 5; 5,5; 6; 7; 8; 9; 10; 11; 12; 13 e 14
- Bits caixa hexagonais: 3; 4; 5 e 6mm
- Bits caixa phillips: PH1; PH2 e PH3
- Bits caixa fenda: 5,5 e 7mm
- Cardan
- Extensão 50mm
- Cabo "T" correção 115mm



S03H2353S

138.90€

Jogo 54 chaves 1/4"

Composição/ medidas em mm:

- Roquete longo de baixo perfil
- 13 Chaves de caixa 1/4" 6 faces extra curtas 4 -14mm
- 2 Extensões de 1/4" 50 e 100mm
- Adaptador magnético para bits de 1/4"
- Ponta porta bits magnético 1/4"
- 4 Bits fenda 3; 4; 5,5; 7 mm
- 4 Bits phillips PH0; PH1; PH2; PH3
- 3 Bits pozi PZ1; PZ2; PZ3
- 8 Bits torx T8; 10; 15; 20; 25; 27; 30; 40
- 8 Bits torx tamperproof T8; 10; 15; 20; 25; 27; 30; 40
- 5 Bits HEX 2; 3; 4; 5; 6mm
- Cardan 1/4"
- Adaptador para bits de 1/4"



S04H2118S

46.40€

Jogo de chaves de caixa de 1/4" com 18 peças

Composição/ medidas em mm:

- R2902 Roquete de 36 dentes
- S04H2 Chaves caixa: 4; 4,5; 5; 5,5; 6; 7; 8; 9; 10; 11; 12 e 13
- S24H2 Extensões de 2" e 4"
- S23H2 Cabo "T" correção
- S15H240 Adaptador universal
- S22H2130 Punho flexível



S04H2141S

79.80€

Jogo de chaves de caixa de 1/4" com 41 peças

Composição/ medidas em mm:

- R3702 Roquete de 48 dentes
- S04H2 Chaves caixa: 4; 5; 5,5; 6; 7; 8; 10; 11; 12 e 13
- S04HD2 Chaves longas de caixa: 7; 8 e 10
- Chaves macho hexagonais: 1,5; 2; 2,5 e 3
- S09H2 Bits hexagonais: 3; 4; 5 e 6
- S07H2 Bits torx: T10; T20; T25; T27; T30 e T40
- S10H2 Bits fenda: 0,8x4; 10x5,5 e 1,2x7
- S11H2 Bits phillips: PH1; PH2 e PH3
- S24H Extensões de 2" e 6"
- S28H1 Punho
- S15H240 Adaptador universal
- S27H2150 Extensão flexível 6"
- S16H3814 Adaptador 3/8 (F) x 1/4" (M)
- Caixa metálica



S04H3125S

86.00€

Jogo de chaves de caixa de 3/8" com 25 peças

Composição/ medidas em mm:

- R3703 Roquete de 48 dentes
- Chaves caixa: 6 a 22
- Chaves de velas: 16 e 21
- S24H Extensões de 75 e 150
- S23H31200 Cabo "T" correção de 200
- S15H356 Cardan
- Caixa metálica



S04H3141S

126.60€

Jogo de chaves de caixa de 3/8" com 40 peças

Composição/ medidas em mm:

- R3703 Roquete de 48 dentes
- S04H3 Chaves caixa: 6 a 24
- Chaves de caixa longas: 14; 15; 17 e 19
- Bits torx: T10; T20; T25; T27; T30; T40; T45 e T50
- Bits fenda: 0,8x4; 1x5,5 e 1,2x8
- Bits phillips: PH1; PH2 e PH3
- 2 Extensões
- Cardan
- Adaptador universal
- Mala de transporte



S04H3157S
151.40€
Jogo de chaves de caixa de 1/4" e 3/8" com 56 peças

Composição/ medidas em mm:

- R3702 Roquete 1/4" de 48 dentes
- R3703 Roquete 3/8" de 48 dentes
- S04H2 Chaves de 1/4": 4; 4,5; 5; 5,5; 6; 7; 8; 9; 10; 11; 12 e 13
- S04HD2 Chaves longas de 1/4": 8; 10; 12; e 13
- S04H3 Chaves de 3/8": 14; 15; 17; 18; 19; 20; 22 e 24
- S04HD3 Chaves longas 3/8": 14; 15; 17
- S17H3 Chaves velas 3/8": 16 e 21
- S09H2 Bits hexagonais: 3; 4; 5 e 6
- S07H2 Bits torx: T10; T15; T20; T25; T27 e T30
- S10H2 Bits fenda: 4; 5,5 e 7
- S11H2 Bits phillips: PH1; PH2 e PH3
- S24H2 2 Extensões 1/4" (50mm + 150mm)
- S24H3 2 Extensões 3/8" (75mm + 250mm)
- S16H302 Adaptador de extensão 1/4" - 3/8"
- S16H403 Adaptador de extensão 1/2" - 3/8"
- S15H356 Adaptador universal 3/8"
- S15H240 Adaptador universal 1/4"
- S26H2150 Punho

S04H3536S
134.20€
Jogo de chaves de caixa de 3/8" com 36 peças

Composição/ medidas em mm:

- R3503 Roquete de 72 dentes
- Chaves caixa: 6 a 22mm
- Chaves mistas: 7 a 17mm
- Chaves de velas: 16 e 21mm
- Extensões de 75; 150 e 225mm
- Cardan
- S16H403 Adaptador
- Caixa metálica

S04H4125S
128.90€
Jogo de chaves de caixa de 1/2" com 25 peças

Composição/ medidas em mm:

- R3704 Roquete de 48 dentes
- S04H4 Chaves caixa: 10 a 24; 27; 30 e 32
- Chaves de velas: 16 e 21
- Extensões de 5" e 10"
- Cabo "T" correção
- Adaptador universal
- Mala de transporte

S04H4524S
139.70€
Jogo de chaves de caixa de 1/2" com 24 peças

Composição/ medidas em mm:

- R3704 Roquete de 48 dentes
- S04H4 Chaves caixa: 10 a 24; 27; 30 e 32
- S24H4 Extensões de 5" e 10"
- S23H41300 Cabo "T" correção
- S15H472 Adaptador universal
- S22H41375 Punho flexível 15"
- Caixa metálica

S04H4728S
144.20€
Jogo de chaves de caixa sextavadas de 1/2" com 28 peças

Composição/ medidas em mm:

- R3704 Roquete de 48 dentes
- S04H4 Chaves caixa: 8 a 28; 30; 32 e 34
- S24H4250 Extensão 10"
- S23H41300 Cabo "T" correção
- S15H472 Adaptador universal
- Caixa metálica

S04H6115S
247.40€
Jogo de chaves de caixa de 3/4" com 14 peças

Composição/ medidas em mm:

- Roquete
- Chaves caixa: 22; 24; 27; 30; 32; 36; 38; 41; 46 e 50
- Extensão de 100 e 200
- Cabo "T" correção

S04H6321S
374.20€
Jogo de chaves de caixa de 3/4" com 20 peças

Composição/ medidas em mm:

- R1206N Roquete reversível de 500
- S04H61 Chaves caixa: 19; 21; 22; 24; 27; 30; 32; 36; 38; 41; 46 e 50
- S24H6 Extensão de 100; 200 e 400
- S22H6475 Cabo articulado 475
- S16H3412 Adaptador 3/4"F para 1/2"M
- S16H3410 Adaptador 3/4"F para 1"M
- S15H6109 Adaptador universal
- Mala de transporte





S04H8115S

705.50€

Jogo de chaves de caixa de 1" com 14 peças

Composição/ medidas em mm:

- Roquete
- Chaves caixa: 36; 41; 46; 50; 55; 60; 65; 70; 75 e 80
- Extensão de 200 e 400
- Cabo de 550



S06H425S

63.40€

Jogo de 25 bits torx de 1/2" e 1/4"

Composição/ medidas em mm:

- S07H2 Bits torx de 1/4": T8; T10; T15; T20; T25; T27 e T30x32
- S07H3 Bits torx de 1/2": T40; T45; T50; T55 e T60x55
- S06H2 Chaves parafusos torx 1/4": E4; E5; E6; E7 e E8
- S06H4 Chaves parafusos torx 1/2": E10; E11; E12; E14 e E18
- H08 Chaves macho torx: T6; T8 e T10



S06H4127S

123.50€

Jogo de 27 bits de 1/2" e 3/8"

Composição/ medidas em mm:

- S09H4 Bits hexagonais de 1/2": 4; 5; 6; 7; 8; 10 e 12x55; 14x60; 17x70; 8x80 e 10x140
- S49H4 Bits estriados de 1/2": M5; M6; M8; M10; M12; M14; M16x55; M10; M12x110 e M8x120
- S09H3 Bits hexagonais de 3/8": 4; 5; 6; 7; 8 e 10x48



S07H4109S

37.60€

Jogo de 9 chaves bits torx de 1/2"

Composição:

- T20; T25; T27; T30; T40; T50; T55 e T60



S09H4109S

38.20€

Jogo de 9 chaves bits hexagonais de 1/2"

Composição:

- H3; H4; H5; H6; H7; H8; H10; H12 e H14



S07H4932S

157.40€

Jogo de 32 chaves bits torx de 1/2"

Composição:

- Bits 55mm: T20; T25; T27; T30; T40; T45; T50; T55; T60 e T70
- Bits 100mm: T20; T25; T27; T30; T40; T45; T50; T55; T60 e T70
- Bits 140mm: T40; T45; T50; T55; T60 e T70
- Bits 200mm: T40; T45; T50; T55; T60 e T70
- Mala de transporte



S63H4132S

156.70€

Jogo de 32 chaves bits de 6 caneluras (Ribe) 1/2"

Composição:

- Bits 55mm: M5; M6; M7; M8; M9; M10; M12; M13 e M14
- Bits 100mm: M5; M6; M7; M8; M9; M10; M12; M13 e M16
- Bits 140mm: M8; M9; M10; M12; M13 e M14
- Bits 200mm: M8; M9; M10; M12; M13 e M14
- Mala de transporte



S64H4126S

132.50€

Jogo de 26 chaves bits XZN 1/2"

Composição:

- Bits 55mm: M5; M6; M8; M10; M12; M14 e M16
- Bits 100mm: M5; M6; M8; M10; M12 e M14
- Bits 140mm: M5; M6; M8; M10; M12 e M14
- Bits 200mm: M8; M10; M12 e M14
- Mala de transporte



S04H52477S
251.40€
Jogo de 77 peças de ferramenta de 1/2" e 1/4"

Composição/ medidas em mm:

R2904	Roquete 1/2" reversível de 36 dentes
R2902	Roquete 1/4" reversível de 36 dentes
S04H4	Chaves caixa 1/2": 12 a 32
S04H21	Chaves caixa 1/4": 4 a 12
S04HD21	Chaves de caixa longas 1/4": 8; 10; 12 e 13
S17H	Chaves de velas 1/2": 16 e 21 mm
W26	Chaves boca/ luneta: 8; 10; 12; 13; 14; 15; 17 e 19
D04	Jogo de chaves fenda
S24H	Extensões 1/2" de 125 e 250
S24H275	Extensão 1/4" com 75
S15H472	Adaptador universal 1/2"
S15H240	Adaptador universal 1/4"
S16H304	Adaptador 3/8"F para 1/2"M
S23H21130	Cabo "T" correção 1/4"
P2810	Alicate ajustável
P088	Alicate universal
	Pontas de 1/4"
M09500	Martelo de mecânico tipo "Alemão" 500g
	Mala de transporte

S04H52460S
188.80€
Jogo de 60 peças de ferramenta de 1/2" e 1/4"

Composição/ medidas em mm:

	Roquete 1/2" de 36 dentes
	Chaves caixa 1/2": 12; 13; 14; 15; 17; 18; 19; 22 e 24
	Chaves caixa 1/4": 6; 8; 9; 10; 11; 12 e 13
	Chaves de velas 1/2": 16 e 21
	Chaves mistas: 8; 10; 12; 13; 14 e 17
	Jogo de chaves fenda/ phillips
	Bits de 1/4": fenda, torx e phillips
	Porta bits de 1/4"
	Extensões 1/2" de 125 e 250
	Extensão 1/4" com 75
	Extensão flexível de 1/4"
	Adaptador 3/8"F para 1/2"M
	Cabo "T" correção 1/4"
	Alicate ajustável
	Alicate universal
	Pontas de 1/4"
	Martelo
	Cardan de 1/2"
	Punho de 1/4"

S04H52478S
304.00€
Jogo de 78 peças de ferramenta de 1/2" e 1/4"

Composição/ medidas em mm:

	Roquete 1/2" de 48 dentes
	Roquete 1/4" de 48 dentes
	Chaves caixa 1/4": 5 a 11
	Chaves caixa longas 1/4": 5 a 12
	Chaves de velas 1/2": 16 e 21
	Chaves caixa 1/2": 12 a 19; 22; 24; 27 e 32
	Chaves mistas: 6 a 17; 19, 21; 22 e 24
	Chaves allen hexagonais: 2,5 a 10
	Chaves allen torx: T10; T15; T20; T25; T27; T30 e T40
	Chaves luneta aberta: 8x10; 11x13; 12x14 e 17x19
	Jogo de chaves fenda/ phillips
	Extensões 1/2" de 125 e 250
	Extensão 1/4" com 50
	Adaptador 3/8"F para 1/2"M
	Cabo "T" correção 1/4"
	Alicate de pressão
	Cardan de 1/2" e 1/4"
	Punho de 1/4"

S04H624101S
330.80€
Jogo de 101 peças de ferramenta de 1/2" e 1/4"

Composição/ medidas em mm:

R2904	Roquete 1/2" reversível de 36 dentes
R2902	Roquete 1/4" reversível de 36 dentes
S04H4	Chaves caixa sextavadas 1/2": 8 a 24; 27; 30 e 32
S04H2	Chaves caixa sextavadas 1/4": 4; 4,5; 5; 5,5; 6; 7; 8; 9 e 10
S17H4	Chaves de velas 1/2": 16 e 21
S06H4	Chaves caixa torx 1/2": E11; E12; E14; E16 e E18
W24	Chaves luneta aberta: 8x10; 11x13; 12x14 e 17x19
W26	Chaves boca/ luneta: 8; 10 a 19; 21; 22 e 24
D04	Jogo de chaves fenda
S24H4	Extensões 1/2" de 125 e 250
S21H4	Extensão 1/2" de 50
S24H2	Extensões 1/4" de 75 e 100
S27H4	Extensão flexível 1/4"
S14H4	Adaptador universal 1/2"
S15H2	Adaptador universal 1/4"
S23H2	Cabo "T" correção 1/4"
S23H4	Cabo "T" correção 1/2"
W27AS8	Alicate ajustável
P087	Alicate universal
AG010034	Caneta magnética
	Pontas de 1/4"
	Pontas XZN - M6; M8; M10 e M12
	Mala de transporte



S04H524127S

525.40€

Jogo de 127 peças de ferramenta de 1/2" e 1/4"



Composição/ medidas em mm:

- R2904 Roquete 1/2" reversível de 36 dentes
- R2902 Roquete 1/4" reversível de 36 dentes
- Chaves caixa 1/2": 8 a 11; 13 a 19; 21; 22; 24; 27; 30 e 32
- Chaves caixa 1/4": 4; 4,5; 5; 5,5; 6 a 13
- Chaves caixa longa 1/2": 10; 12; 13; 14; 15; 17 e 19
- Chaves caixa longa 1/4": 7; 8; 10; 12 e 13
- Chaves de velas 1/2": 16 e 21
- Chaves caixa torx 1/4": E4; E5; E6; E7 e E8
- Chaves torx 1/2": E10; E12; E14; E16; E18; E20; E22 e E24
- Chaves mistas: 6 a 17; 19; 21; 22; 24; 27; 30 e 32
- Chaves luneta aberta: 8x10; 9x11; 12x13; 14x17 e 17x19
- Chaves hexagonais curtas: 1,5; 2; 2,5; 3; 4; 5; 6; 8 e 10
- Chaves torx: T10; T15; T20; T25; T27; T30 e T40
- D71S Chaves fendas com punho antideslizante
- D71P Chaves phillips com punho antideslizante
- Jogo de punções e escopros
- S21H Extensões 1/4" de 50x150 e de 1/2" 50mm
- S24H Extensões 1/2" de 125 e 250 e de 1/4" de 75
- Extensão flexível 1/4" de 145
- Cabo "T" corrediço 1/4" de 130 e 1/2" de 250
- Cabo articulado 1/2" de 375
- P2810 Alicates ajustáveis
- P8606 Alicates de corte
- P8007 Alicates universais
- AG010034 Caneta magnética
- M09500 Martelo de mecânico tipo "Alemão" 500g
- Cardan de 1/2" e 1/4"
- Mala de transporte



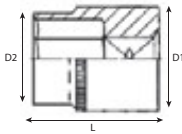

S04H21

Chave de caixa sextavada 1/4"

Ref.	Medida (mm)	D1 (mm)	D2 (mm)	L (mm)		Preço
S04H2104	4	11,8	6,8	25	 	0.95€
S04H21045	4,5	11,8	7,3	25		0.95€
S04H2105	5	11,8	8	25		0.95€
S04H21055	5,5	11,8	8,6	25		0.95€
S04H2106	6	11,8	9,2	25		0.95€
S04H2107	7	11,8	10,5	25		0.95€
S04H2108	8	11,4	11,7	25		1.00€
S04H2109	9	11,6	12,7	25		1.10€
S04H2110	10	12,8	13,7	25		1.10€
S04H2111	11	14,4	15,7	25		1.10€
S04H2112	12	13,7	16,6	25		1.10€
S04H2113	13	13,9	17,6	25		1.20€
S04H2114	14	17,5	20	25		1.30€

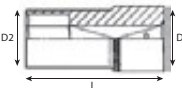

S04HD21

Chave de caixa sextavada longa 1/4"

Ref.	Medida (mm)	D1 (mm)	D2 (mm)	L (mm)		Preço
S04HD2105	5	11,8	8,1	50	 	1.60€
S04HD2106	6	12	9,2	50		1.60€
S04HD2107	7	12	10,5	50		1.60€
S04HD2108	8	11,5	12	50		1.60€
S04HD2109	9	11,3	13,2	50		1.70€
S04HD2110	10	13,3	14,4	50		1.70€
S04HD2111	11	14,8	15,9	50		1.90€
S04HD2112	12	15,8	17	50		1.90€
S04HD2113	13	16,8	17,8	50		2.00€

S04H31

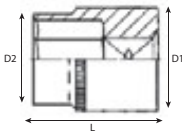
Chave de caixa sextavada 3/8"

Ref.	Medida (mm)	D1 (mm)	D2 (mm)	L (mm)		Preço
S04H3106	6	16,8	9,6	28	 	1.20€
S04H3107	7	16,8	10,7	28		1.20€
S04H3108	8	16,8	12	28		1.20€
S04H3109	9	16,8	13,3	28		1.30€
S04H3110	10	16,8	14,4	28		1.30€
S04H3111	11	16,8	15,8	28		1.30€
S04H3112	12	16	16,8	28		1.30€
S04H3113	13	18	19	28		1.30€
S04H3114	14	18,8	19,7	28		1.40€
S04H3115	15	19,8	20,8	28		1.40€
S04H3116	16	20,8	22	28		1.40€
S04H3117	17	22	23,8	28		1.70€
S04H3118	18	24,1	25,7	28		1.80€
S04H3119	19	24,1	25,7	28		1.90€
S04H3120	20	25	27,6	32		2.10€
S04H3121	21	25	27,6	32		2.20€
S04H3122	22	27,8	29,6	32	2.40€	
S04H3124	24	29,8	31	32	2.60€	



S04HD31

Chave de caixa sextavada longa 3/8"

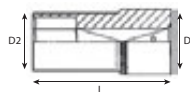

Ref.	Medida (mm)	D1 (mm)	D2 (mm)	L (mm)	Preço
S04HD3109	9	16,8	13,3	63	2.30€
S04HD3110	10	17	14,4	63	2.30€
S04HD3111	11	17	15,8	63	2.50€
S04HD3112	12	17	17,7	63	2.60€
S04HD3113	13	18	19	63	2.60€
S04HD3114	14	18,8	19,7	63	2.60€
S04HD3115	15	19,8	20,8	63	2.80€
S04HD3116	16	20,8	22	63	3.00€
S04HD3117	17	22,8	23,8	63	3.20€
S04HD3119	19	23,8	26	63	3.50€
S04HD3120	20	24,8	27,8	63	3.60€
S04HD3121	21	25,8	28	63	3.60€
S04HD3124	24	28	24	63	4.30€



S04H41

Chave de caixa sextavada 1/2"

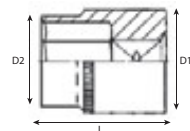

Ref.	Medida (mm)	D1 (mm)	D2 (mm)	L (mm)	Preço
S04H4108	8	21,8	13,8	38	1.80€
S04H4109	9	21,8	14,3	38	1.80€
S04H4110	10	21,8	15,4	38	1.80€
S04H4111	11	21,8	16,7	38	1.80€
S04H4112	12	21,8	18	38	1.80€
S04H4113	13	21,8	19	38	1.80€
S04H4114	14	22	20,3	38	1.80€
S04H4115	15	22	21,3	38	1.90€
S04H4116	16	22	23,3	38	1.90€
S04H4117	17	23	23,8	38	2.00€
S04H4118	18	23,5	24,8	38	2.20€
S04H4119	19	24	27	38	2.20€
S04H4120	20	24	28	38	2.40€
S04H4121	21	24	29	38	2.50€
S04H4122	22	28	30	38	2.90€
S04H4123	23	28	30,7	38	3.20€
S04H4124	24	28	31,8	38	3.20€
S04H4125	25	28	33,8	38	3.70€
S04H4126	26	30	34	42	4.00€
S04H4127	27	28	35,7	42	4.00€
S04H4128	28	30	38	42	4.10€
S04H4129	29	32	38	42	4.90€
S04H4130	30	34	39,8	42	4.90€
S04H4132	32	36	42	42	5.10€
S04H4134	34	40	45	48	7.00€
S04H4136	36	41	48	48	9.10€



S04HD41

Chave de caixa sextavada longa 1/2"

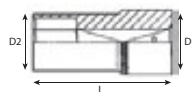

Ref.	Medida (mm)	D1 (mm)	D2 (mm)	L (mm)	Preço
S04HD4109	12	21,8	12,7	76	4.50€
S04HD4110	10	21,8	15,4	76	4.50€
S04HD4111	11	21,8	16,7	76	4.50€
S04HD4112	12	21,8	18	76	4.50€
S04HD4113	13	21,8	19	76	4.60€
S04HD4114	14	22	20,3	76	4.60€
S04HD4115	15	22	21,3	76	4.60€
S04HD4116	16	22	23	76	4.60€
S04HD4117	17	23	23,8	76	4.70€
S04HD4118	18	23	24,8	76	4.70€
S04HD4119	19	24	25,8	76	4.70€
S04HD4120	20	24	28	76	4.90€
S04HD4121	21	24	29	76	4.90€
S04HD4122	22	26	30	76	4.90€
S04HD4123	23	28	31,8	76	4.90€
S04HD4124	24	28	31,8	76	4.90€
S04HD4125	25	28	33,8	76	7.10€
S04HD4126	26	28	33,8	76	7.40€
S04HD4127	27	28	35,7	76	7.70€
S04HD4128	28	30	38	76	8.40€
S04HD4130	30	34	39,8	76	8.90€
S04HD4132	32	36	42	76	9.70€

S04H61

Chave de caixa sextavada 3/4"

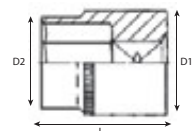

Ref.	Medida (mm)	D1 (mm)	D2 (mm)	L (mm)	Preço
S04H6119	19	30	36	49,5	6.70€
S04H6121	21	32	36	49,5	6.90€
S04H6122	22	33	36	49,5	7.10€
S04H6124	24	35	36	49,5	7.30€
S04H6127	27	38	36	52	7.70€
S04H6128	28	39	36	52	7.80€
S04H6130	30	42	38	54	8.60€
S04H6132	32	44	38	56	9.00€
S04H6134	34	46	38	58	10.40€
S04H6136	36	50	42	58	11.30€
S04H6138	38	52	45	60	12.10€
S04H6141	41	56	45	64	13.20€
S04H6146	46	62	48	68	16.10€
S04H6150	50	68	48	72	17.80€
S04H6152	52	69	48	73	25.00€

S04H63

Chave de caixa 3/4" - 12 faces

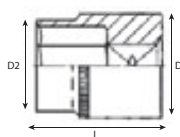

Ref.	Medida (mm)	D1 (mm)	D2 (mm)	L (mm)	Preço
S04H6319	19	30	36	49,5	7.50€
S04H6321	21	32	36	49,5	7.50€
S04H6322	22	33	36	49,5	7.50€
S04H6323	23	34	36	49,5	7.50€
S04H6324	24	35	36	49,5	7.50€
S04H6325	25	37	36	50	7.50€
S04H6326	26	37	36	50	7.60€
S04H6327	27	38	36	52	8.30€
S04H6329	29	40	38	53	8.30€
S04H6330	30	42	38	54	8.60€
S04H6332	32	44	38	56	8.80€
S04H6334	34	46	38	58	10.70€
S04H6336	36	50	42	58	11.40€
S04H6338	38	52	45	60	11.70€
S04H6341	41	56	45	64	13.40€
S04H6346	46	62	48	68	16.70€
S04H6350	50	68	48	72	18.30€
S04H6355	55	74	48	76	23.50€
S04H6356	56	75	48	76	24.20€
S04H6360	60	70	48	78	28.80€
S04H6365	65	87	60	85	40.40€



S04H64

Chave de caixa 3/4" - 12 faces (em polegadas)

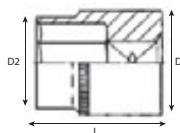

Ref.	Medida	D1 (mm)	D2 (mm)	L (mm)	Preço
S04H6419	3/4"	30	36	49,5	7.70€
S04H6421	13/16"	32	36	49,5	7.70€
S04H6422	7/8"	33	36	49,5	7.70€
S04H6424	15/16"	34	36	49,5	7.70€
S04H6426	1"	35	36	49,5	8.00€
S04H6427	1-1/16"	38	36	52	8.00€
S04H6429	1-1/18"	40	38	53	8.30€
S04H6430	1-3/16"	42	38	54	8.40€
S04H6432	1-1/4"	44	38	56	8.60€
S04H6433	1-5/16"	46	38	56	8.80€
S04H6435	1-3/8"	48	42	58	10.20€
S04H6436	1-7/16"	50	42	58	10.50€
S04H6438	1-1/2"	52	45	60	11.30€
S04H6440	1-9/16"	52	45	60	12.50€
S04H6441	1-5/8"	56	45	64	12.50€
S04H6443	1-11/16"	56	45	64	13.30€
S04H6444	1-3/4"	56	45	64	13.90€
S04H6446	1-13/16"	62	48	68	14.60€
S04H6447	1-7/8"	62	48	68	18.50€
S04H6450	2"	68	48	72	18.70€
S04H6456	2/14"	75	48	76	24.30€



S04H83

Chave de caixa 1" - 12 faces

Ref.	Medida (mm)	D1 (mm)	D2 (mm)	L (mm)	Preço
S04H8355	55	76	57	80	33.30€
S04H8360	60	82	57	84	39.30€
S04H8365	65	88	57	87	44.70€

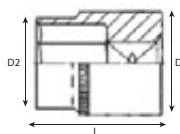
S05HD41

Chave de caixa sextavada longa 1/2"

Ref.	Medida (mm)	D1 (mm)	D2 (mm)	L (mm)	Preço
S05HD4110	10	21,8	15,4	76	4.20€
S05HD4111	11	21,8	16,7	76	4.20€
S05HD4112	12	21,8	18	76	4.30€
S05HD4113	13	21,8	19	76	4.40€
S05HD4117	17	23,8	23,8	76	4.60€
S05HD4118	18	24,8	16,7	76	4.80€
S05HD4119	19	25,8	25,8	76	5.10€
S05HD4120	20	27,9	27,9	76	5.10€
S05HD4121	21	27,9	27,9	76	5.10€
S05HD4122	22	30	30	76	5.40€
S05HD4123	23	31,8	31,8	76	6.30€
S05HD4124	24	31,8	31,8	76	8.00€
S05HD4127	27	36	36	76	9.20€
S05HD4130	30	40	40	76	9.20€
S05HD4132	32	42	42	76	9.90€

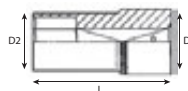



S04HD411S 58.20€

Jogo de 10 chaves de caixa longas de 1/2" - 6 faces

Composição:

S04HD4 Chaves: 10; 11; 13; 14; 15; 17; 19; 21; 22 e 24mm



S05H4113S 42.70€

Jogo de 13 chaves de caixa de 1/2" - 12 faces

Composição:

S05H4 Chaves: 10; 12; 13; 14; 15; 16; 17; 18; 19; 20; 21; 22 e 24mm



S05H4213S 51.60€

Jogo de 13 chaves de caixa de 1/2" SAE

Composição:

Chaves: 3/8"; 7/16"; 1/2"; 9/16"; 5/8"; 11/16"; 3/4"; 13/16"; 7/8"; 15/16"; 1"; 1-1/16" e 1-1/8"



S05HD4113S 86.70€

Jogo de 13 chaves de caixa longas 1/2" - 6 faces

Composição:

S05HD4 Chaves: 11; 13; 14; 15; 17; 19; 21; 22; 23; 24; 27; 30 e 32mm



S05HD4213S 80.90€

Jogo de 13 chaves de caixa longas 1/2" SAE

Composição:

Chaves: 7/16"; 1/2"; 9/16"; 5/8"; 11/16"; 3/4"; 13/16"; 7/8"; 15/16"; 1"; 1-1/16"; 1-1/8" e 1-1/4"



S06H37S 20.70€

Jogo de 7 chaves de caixa para parafusos torx 3/8"

Composição:

S06H3 Chaves: E10; E11; E12; E14; E16; E18 e E20



S06H49S 31.80€

Jogo de 9 chaves de caixa para parafusos torx 1/2"

Composição:

S06H4 Chaves: E10; E11; E12; E14; E16; E18; E20; E22 e E24



S66H41

Chaves de caixa de 1/2" - 12 faces

Ref.	Medida (mm)	Preço
S66H4108	8	1.60€
S66H4109	9	1.60€
S66H4110	10	1.60€
S66H4111	11	1.70€
S66H4112	12	1.70€
S66H4113	13	1.70€
S66H4114	14	1.70€
S66H4115	15	1.90€
S66H4116	16	1.90€
S66H4117	17	2.20€
S66H4118	18	2.20€
S66H4119	19	2.20€
S66H4120	20	2.70€
S66H4121	21	2.70€
S66H4122	22	3.10€
S66H4124	24	3.90€
S66H4125	25	4.10€
S66H4126	26	4.60€
S66H4127	27	4.70€
S66H4128	28	4.80€
S66H4130	30	5.50€
S66H4132	32	8.30€
S66H4136	36	8.80€



S66HD41

Chaves de caixa longas de 1/2" - 12 faces



Ref.	Medida (mm)	Preço
S66HD4110	10	2.80€
S66HD4111	11	3.10€
S66HD4112	12	3.10€
S66HD4113	13	3.20€
S66HD4114	14	3.20€
S66HD4115	15	3.20€
S66HD4116	16	3.40€
S66HD4117	17	3.50€
S66HD4118	18	3.70€
S66HD4119	19	3.70€
S66HD4120	20	4.30€
S66HD4121	21	4.30€
S66HD4122	22	5.00€
S66HD4123	23	5.00€
S66HD4124	24	5.00€
S66HD4127	27	6.20€
S66HD4130	30	8.00€
S66HD4132	32	8.70€

Conversor de polegadas em mm

Polegadas	Milímetros
1/8"	~3,2
3/16"	~4,8
1/4"	~6,4
5/16"	~7,9
3/8"	~9,5
7/16"	~11,1
1/2"	~12,7
9/16"	~14,3
5/8"	~15,9
11/16"	~17,5
3/4"	~19,1
13/16"	~20,6
7/8"	~22,2
15/16"	~23,8
1"	~25,4



PHILLIPS	FENDA	TORX	TORX TEMP.	HEXAGONAL	XZN
----------	-------	------	------------	-----------	-----

S06H2

Chave de caixa torx 1/4"

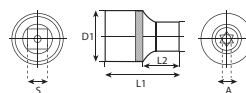

Ref.	Medida	D1 (mm)	D2 (mm)	L1 (mm)	L2 (mm)	Preço
S06H204	E4	12	6,2	25	11	1.50€
S06H205	E5	12	7,2	25	11	1.50€
S06H206	E6	12	8,2	25	11	1.50€
S06H207	E7	12	9	25	11	1.50€
S06H208	E8	12	10,3	25	11	1.50€
S06H210	E10					1.50€
S06H211	E11					1.50€

S06H3

Chave de caixa torx 3/8"



Ref.	Medida	D1 (mm)	D2 (mm)	L1 (mm)	Preço
S06H306	E6	17	11,2	28	2.00€
S06H307	E7	17	11,2	28	2.00€
S06H308	E8	17	11,2	28	2.00€
S06H310	E10	17	13,2	28	2.00€
S06H311	E11	17	13,8	28	2.00€
S06H312	E12	17	14,8	28	2.00€
S06H314	E14	18	16,8	28	2.00€
S06H316	E16	20	18,8	28	2.00€
S06H318	E18	22	20,8	28	2.00€
S06H320	E20	24	22,8	28	2.30€

S06H4

Chave de caixa torx 1/2"



Ref.	Medida	D1 (mm)	D2 (mm)	L1 (mm)	L2 (mm)	Preço
S06H410	E10	22	13,2	38	17	2.60€
S06H411	E11	22	13,9	38	17	2.80€
S06H412	E12	22	15	38	17	2.80€
S06H414	E14	22	16,7	38	17	2.80€
S06H416	E16	22	18,8	38	17	2.80€
S06H418	E18	22	20,8	38	17	2.90€
S06H420	E20	22	23	38	17	3.10€
S06H422	E22	22	25	38	17	3.10€
S06H424	E24	22	27	38	17	3.80€



S07H2

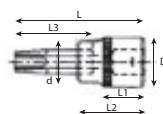

Chave de caixa bit torx 1/4" - 37mm



Ref.	Medida	L1 (mm)	L2 (mm)	L3 (mm)	L (mm)	D (mm)	d (mm)	Preço
S07H206	T6	13	19	25	37	12	10,8	1.20€
S07H207	T7	13	19	25	37	12	10,8	1.20€
S07H208	T8	13	19	25	37	12	10,8	1.20€
S07H209	T9	13	19	25	37	12	10,8	1.20€
S07H210	T10	13	19	25	37	12	10,8	1.20€
S07H215	T15	13	19	25	37	12	10,8	1.20€
S07H220	T20	13	19	25	37	12	10,8	1.20€
S07H225	T25	13	19	25	37	12	10,8	1.20€
S07H227	T27	13	19	25	37	12	10,8	1.20€
S07H230	T30	13	19	25	37	12	10,8	1.20€
S07H240	T40	13	19	25	37	12	10,8	1.20€

S07H3

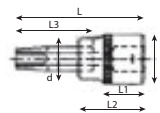
Chave de caixa bit torx 3/8" - 48mm



Ref.	Medida	L1 (mm)	L2 (mm)	L3 (mm)	L (mm)	D (mm)	d (mm)	Preço
S07H310	T10	16,5	26	30	48	18	13,8	1.50€
S07H315	T15	16,5	26	30	48	18	13,8	1.50€
S07H320	T20	16,5	26	30	48	18	13,8	1.50€
S07H325	T25	16,5	26	30	48	18	13,8	1.50€
S07H327	T27	16,5	26	30	48	18	13,8	1.50€
S07H330	T30	16,5	26	30	48	18	13,8	1.50€
S07H340	T40	16,5	26	30	48	18	13,8	1.50€
S07H345	T45	16,5	26	30	48	18	15,8	1.80€
S07H350	T50	16,5	26	30	48	18	15,8	1.80€
S07H355	T55	16,5	26	30	48	18	16,1	1.90€
S07H360	T60	16,5	26	30	48	18	16,1	2.10€

S07H4

Chave de caixa bit torx 1/2" - 55mm



Ref.	Medida	L1 (mm)	L2 (mm)	L3 (mm)	L (mm)	D (mm)	d (mm)	Preço
S07H420	T20	20	38	30	55	22	15	2.70€
S07H425	T25	20	38	30	55	22	15	2.70€
S07H427	T27	20	38	30	55	22	15	2.90€
S07H430	T30	20	38	30	55	22	15	2.90€
S07H440	T40	20	38	30	55	22	15	2.90€
S07H445	T45	20	38	30	55	22	15	2.90€
S07H450	T50	20	38	30	55	22	15	3.00€
S07H455	T55	20	38	30	55	22	17	3.00€
S07H460	T60	20	38	30	55	24	22	3.20€
S07H470	T70	20	38	30	55	24	22	3.50€



S07H43



Chave de caixa bit torx 1/2" - 100mm



Ref.	Medida	L1 (mm)	L2 (mm)	L3 (mm)	L (mm)	D (mm)	d (mm)	Preço
S07H4320	T20	20	38	75	100	24	15	4.10€
S07H4325	T25	20	38	75	100	24	15	4.10€
S07H4327	T27	20	38	75	100	24	15	4.10€
S07H4330	T30	20	38	75	100	24	15	4.10€
S07H4340	T40	20	38	75	100	24	15	4.10€
S07H4345	T45	20	38	75	100	24	15	4.10€
S07H4350	T50	20	38	75	100	24	15	4.10€
S07H4352	T52	20	38	75	100	24	15	4.20€
S07H4355	T55	20	38	75	100	24	17	4.20€
S07H4360	T60	20	38	75	100	24	22	4.50€
S07H4370	T70	20	38	75	100	24	22	4.90€



S09H2



Chave de caixa bit hexagonal 1/4" - 37mm

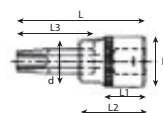

Ref.	Medida	L1 (mm)	L2 (mm)	L3 (mm)	L (mm)	D (mm)	d (mm)	Preço
S09H203	H3	13	19	25	37	12	10,8	1.30€
S09H204	H4	13	19	25	37	12	10,8	1.30€
S09H205	H5	13	19	25	37	12	10,8	1.30€
S09H206	H6	13	19	25	37	12	10,8	1.30€
S09H207	H7	13	19	25	37	12	10,8	1.30€

S09H3



Chave de caixa bit hexagonal 3/8" - 48mm



Ref.	Medida	L1 (mm)	L2 (mm)	L3 (mm)	L (mm)	D (mm)	d (mm)	Preço
S09H303	H3	16,5	26	30	48	18	13,8	1.50€
S09H304	H4	16,5	26	30	48	18	13,8	1.50€
S09H305	H5	16,5	26	30	48	18	13,8	1.50€
S09H306	H6	16,5	26	30	48	18	13,8	1.50€
S09H307	H7	16,5	26	30	48	18	15,8	1.50€
S09H308	H8	16,5	26	30	48	18	15,8	1.80€
S09H310	H10	16,5	26	30	48	18	16,1	1.80€
S09H312	H12	16,5	26	30	48	18	16,1	2.00€
S09H314	H14	16,5	26	30	48	18	16,1	2.40€



S09H4

Chave de caixa bit hexagonal 1/2" - 55mm



Ref.	Medida	L1 (mm)	L2 (mm)	L3 (mm)	L (mm)	D (mm)	d (mm)	Preço
S09H404	H4	20	38	30	55	24	15	2.80€
S09H405	H5	20	38	30	55	24	15	2.80€
S09H406	H6	20	38	30	55	24	15	2.80€
S09H407	H7	20	38	30	55	24	15	2.80€
S09H408	H8	20	38	30	55	24	15	2.80€
S09H410	H10	20	38	30	55	24	17,8	3.10€
S09H412	H12	20	38	30	55	24	22	3.30€
S09H414	H14	20	38	30	55	24	22	3.40€
S09H416	H16	20	38	30	55	24	22	3.60€
S09H417	H17	20	38	30	55	24	22	4.50€
S09H419	H19	20	38	30	55	24	22	4.90€

S09H43



Chave de caixa bit hexagonal 1/2" - 100mm



Ref.	Medida	L1 (mm)	L2 (mm)	L3 (mm)	L (mm)	D (mm)	d (mm)	Preço
S09H4304	H4	20	38	75	100	24	15	3.90€
S09H4305	H5	20	38	75	100	24	15	4.20€
S09H4306	H6	20	38	75	100	24	15	4.20€
S09H4307	H7	20	38	75	100	24	15	4.20€
S09H4308	H8	20	38	75	100	24	15	4.20€
S09H4309	H9	20	38	75	100	24	15	4.20€
S09H4310	H10	20	38	75	100	24	20,8	4.20€
S09H4312	H12	20	38	75	100	24	22	4.30€
S09H4314	H14	20	38	75	100	24	22	4.60€
S09H4316	H16	20	38	75	100	24	22	5.50€
S09H4317	H17	20	38	75	100	24	22	5.80€
S09H4319	H19	20	38	75	100	24	22	8.20€

S10H2

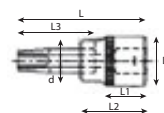
Chave de caixa bit fenda 1/4" - 37mm



Ref.	Medida (mm)	L1 (mm)	L2 (mm)	L3 (mm)	L (mm)	D (mm)	d (mm)	Preço
S10H230	3	13	21	25	37	12	10,8	1.30€
S10H235	3,5	13	21	25	37	12	10,8	1.30€
S10H240	4	13	21	25	37	12	10,8	1.30€
S10H245	4,5	13	21	25	37	12	10,8	1.30€
S10H250	5	13	21	25	37	12	10,8	1.30€
S10H255	5,5	13	21	25	37	12	10,8	1.30€
S10H260	6	13	21	25	37	12	10,8	1.30€
S10H270	7	13	21	25	37	12	10,8	1.40€



S10H3



Chave de caixa bit fenda 3/8" - 48mm

Ref.	Medida (mm)	L1 (mm)	L2 (mm)	L3 (mm)	L (mm)	D (mm)	d (mm)	Preço
S10H340	4	15,5	26,5	30	48	18	13,8	1.40€
S10H350	5	15,5	26,5	30	48	18	13,8	1.40€
S10H355	5,5	15,5	26,5	30	48	18	13,8	1.40€
S10H360	6	15,5	26,5	30	48	18	13,8	1.40€
S10H370	7	15,5	26,5	30	48	18	13,8	1.40€
S10H380	8	15,5	26,5	30	48	18	15,8	1.40€
S10H3100	10	15,5	26,5	30	48	20	17,8	1.70€
S10H3120	12	15,5	26,5	30	48	20	17,8	2.10€



S10H4



Chave de caixa bit fenda 1/2" - 55mm

Ref.	Medida (mm)	L1 (mm)	L2 (mm)	L3 (mm)	L (mm)	D (mm)	d (mm)	Preço
S10H480	8	20	36	30	55	22	17,8	2.90€
S10H490	9	20	36	30	55	22	17,8	3.10€
S10H4100	10	20	36	30	55	22	17,8	3.20€
S10H4110	11	20	36	30	55	24	20,8	3.30€
S10H4120	12	20	36	30	55	24	20,8	3.30€



S11H2



Chave de caixa bit phillips 1/4" - 37mm

Ref.	Medida	L1 (mm)	L2 (mm)	L3 (mm)	L (mm)	D (mm)	d (mm)	Preço
S11H200	PH0	13	19	25	37	12	10,8	1.30€
S11H201	PH1	13	19	25	37	12	10,8	1.30€
S11H202	PH2	13	19	25	37	12	10,8	1.30€
S11H203	PH3	13	19	25	37	12	10,8	1.30€



S11H3



Chave de caixa bit phillips 3/8" - 48mm

Ref.	Medida	L1 (mm)	L2 (mm)	L3 (mm)	L (mm)	D (mm)	d (mm)	Preço
S11H300	PH0	16,5	26	30	48	18	13,8	1.40€
S11H301	PH1	16,5	26	30	48	18	13,8	1.40€
S11H302	PH2	16,5	26	30	48	18	13,8	1.40€
S11H303	PH3	16,5	26	30	48	18	15,8	1.40€
S11H304	PH4	16,5	26	30	48	18	15,8	1.70€

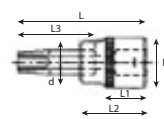

S11H4



Chave de caixa bit phillips 1/2" - 55mm

Ref.	Medida	L1 (mm)	L2 (mm)	L3 (mm)	L (mm)	D (mm)	d (mm)	Preço
S11H402	PH2	55	38	30	55	24	15	2.90€
S11H403	PH3	55	38	30	55	24	15	2.90€
S11H404	PH4	55	38	30	55	24	15	2.90€



S07H45

Chave de caixa bit torx de 1/2"

Ref.	Medida	Comp. (mm)	Preço
S07H4530	T30	200	6.90€
S07H4540	T40	200	6.90€
S07H4545	T45	200	7.20€

S08H311S

17.90€

Jogo de 11 bits de 1/4" e 3/8" torx tamperproof

Composição:

Chaves de 1/4": T8; T10; T15; T20; T25 e T27

Chaves de 3/8": T30; T40; T45; T50 e T55

S49H4

Chave de caixa bits estriado XZN de 1/2"

Ref.	Medida	Comp. (mm)	Preço
S49H4105	M5	55	3.70€
S49H4106	M6	55	3.80€
S49H4108	M8	55	3.80€
S49H4110	M10	55	3.80€
S49H4112	M12	55	3.90€
S49H4114	M14	55	4.30€
S49H4116	M16	55	5.40€
S49H4308	M8	100	5.00€
S49H4310	M10	100	5.30€
S49H4312	M12	100	5.90€
S49H4314	M14	100	7.00€
S49H4318	M18	100	10.90€

S50H3106S

15.50€

Jogo de 6 bits hexagonais 3/8"

Composição:

Chaves: 4; 5; 6; 7; 8 e 10 mm

S50H3206S

15.40€

Jogo de 6 bits hexagonais 3/8" SAE

Composição:

Chaves: 5/32"; 3/16"; 7/32"; 1/4"; 5/16" e 3/8"

S54H5509S

18.00€

Jogo de 9 chaves de torx de 1/4" e 3/8"

Composição:

S54H2 Chaves de 1/4": T10; T15; T20 e T25

S54H3 Chaves de 3/8": T25; T30; T40; T45 e T50

S63H33

Chave de caixa Ribe 3/8" - 90mm

Ref.	Medida	Comp. (mm)	Preço
S63H3306	M6	90	2.00€
S63H3307	M7	90	2.40€
S63H3308	M8	90	2.40€
S63H3310	M10	90	3.20€

S63H43

Chave de caixa Ribe 1/2" - 100mm

Ref.	Medida	Comp. (mm)	Preço
S63H4306	M6	100	3.90€
S63H4307	M7	100	4.10€
S63H4308	M8	100	4.20€
S63H4310	M10	100	4.40€
S63H4312	M12	100	4.70€
S63H4313	M13	100	4.80€

S63H44

Chave de caixa Ribe 1/2" - 55mm

Ref.	Medida	Comp. (mm)	Preço
S63H4405	M5	55	3.20€
S63H4406	M6	55	3.20€
S63H4407	M7	55	3.20€
S63H4408	M8	55	3.50€
S63H4409	M9	55	3.50€
S63H4410	M10	55	3.50€
S63H4412	M12	55	4.30€
S63H4413	M13	55	5.00€
S63H4414	M14	55	6.10€



S63H4507S

28.00€

Jogo de 7 bits longos 6 caneluras (Ribe) 3/8" e 1/2"

Composição:

Bits 3/8" de 90 mm: M6; M7; M8 e M10

Bits 1/2" de 100 mm: M12; M13 e M14



S63H46

Chave de caixa Ribe 1/2" - 100mm



Ref.	Medida	Comp. (mm)	Preço
S63H4605	M5	100	3.90€
S63H4606	M6	100	3.90€
S63H4607	M7	100	3.90€
S63H4608	M8	100	4.20€
S63H4609	M9	100	4.20€
S63H4610	M10	100	4.30€
S63H4612	M12	100	5.20€
S63H4613	M13	100	6.20€
S63H4614	M14	100	6.20€

S63H47

Chave de caixa Ribe 1/2" - 140mm



Ref.	Medida	Comp. (mm)	Preço
S63H4708	M8	140	4.90€
S63H4709	M9	140	4.90€
S63H4710	M10	140	4.90€
S63H4712	M12	140	6.20€
S63H4713	M13	140	7.10€
S63H4714	M14	140	7.10€

S63H48

Chave de caixa Ribe 1/2" - 200mm



Ref.	Medida	Comp. (mm)	Preço
S63H4808	M8	200	5.70€
S63H4809	M9	200	5.80€
S63H4810	M10	200	6.00€
S63H4812	M12	200	7.40€
S63H4813	M13	200	8.70€
S63H4814	M14	200	8.80€

C-DMH



Barra magnética para chaves de caixa

Ref.	Medida	Capacid. (chaves)	Preço
C-DMH212	1/4"	12	19.40€
C-DMH314	3/8"	14	28.70€
C-DMH414	1/2"	12	30.90€

MSH

Régua suporte para chaves de caixa



Ref.	Medida	Capacid. (chaves)	Preço
MSH1214	1/2"	14	2.70€
MSH1414	1/4"	14	2.20€
MSH3814	3/8"	14	2.40€

S64H4

Chave de caixa bits estriado XZN de 1/2"



Ref.	Medida	Comp. (mm)	Preço
S64H4104	M4	55	3.30€
S64H4105	M5	55	3.30€
S64H4106	M6	55	3.30€
S64H4107	M7	55	3.30€
S64H4109	M9	55	3.30€
S64H4112	M12	55	4.10€
S64H4113	M13	55	4.90€
S64H4114	M14	55	5.10€
S64H4204	M4	100	3.90€
S64H4205	M5	100	4.00€
S64H4206	M6	100	4.30€
S64H4207	M7	100	4.40€
S64H4208	M8	100	4.50€
S64H4209	M9	100	4.50€
S64H4210	M10	100	4.50€
S64H4212	M12	100	5.40€
S64H4214	M14	100	6.50€
S64H4216	M16	100	7.30€
S64H4218	M18	100	12.60€
S64H4705	M5	140	4.60€
S64H4706	M6	140	4.60€
S64H4708	M8	140	5.00€
S64H4709	M9	140	5.00€
S64H4710	M10	140	5.00€
S64H4712	M12	140	5.90€
S64H4714	M14	140	7.10€
S64H4808	M8	200	5.70€
S64H4810	M10	200	5.70€
S64H4812	M12	200	7.30€
S64H4814	M14	200	8.30€



S15H
Cardan

Ref.	Medida	D1 (mm)	D2 (mm)	L (mm)	Acabamento	Preço
S15H240	1/4"	14	14	35	Mate	3.00€
S15H356	3/8"	18	18	49	Mate	4.50€
S15H472	1/2"	25	25	69	Mate	5.70€
S15H6109	3/4"	39,7	39,5	106,2	Polido	30.70€

S16H
Adaptador

Ref.	Medida	A (mm)	D1 (mm)	D2 (mm)	L (mm)	Acabamento	Preço
S16H1234	1/2" F - 3/4" M	19	12,7	27	45	Polido	5.20€
S16H1238	1/2" F - 3/8" M	9,52	12,7	22	34	Mate	1.70€
S16H1438	1/4" F - 3/8" M	9,52	6,35	14	25	Mate	1.30€
S16H3410	3/4" F - 1" M	25,3	19,05	39,7	59,6	Polido	13.30€
S16H3412	3/4" F - 1/2" M	12,7	19,05	35	51	Polido	8.40€
S16H3812	3/8" F - 1/2" M	12,7	9,52	17	35	Mate	1.50€
S16H3814	3/8" F - 1/4" M	6,35	9,75	18,6	28	Mate	1.20€

S16H
Adaptador

Ref.	Medida	A (mm)	D1 (mm)	D2 (mm)	L (mm)	Acabamento	Preço
S16H302	1/4" M - 3/8" F	6,35	9,75	18,6	28	Mate	2.50€
S16H304	1/2" M - 3/8" F	12,7	9,75	23,5	43,7	Mate	3.60€
S16H403	3/8" M - 1/2" F	9,5	12,9	23,5	40	Mate	3.60€

S17H
Chave de velas

Ref.	Medida	A1 (mm)	D1 (mm)	D2 (mm)	L (mm)	Acabamento	Preço
S17H3116	3/8"	16	21,7	18,8	65	Mate	2.20€
S17H3121	3/8"	21	27,6	21,5	65	Mate	2.90€
S17H4116	1/2"	16	21,8	21,8	65	Mate	2.00€
S17H4121	1/2"	21	27,6	23,6	65	Mate	2.90€

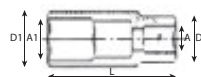

S17H3414

7.30€

Chave de velas 12 faces 3/8"

Medida: 14mm
Acabamento: Mate



S21H

Extensão

Ref.	Quadra	Medida (mm)	Acabamento	Preço
S21H4150	1/2"	50	Mate	3.90€
S21H4175	1/2"	75	Mate	4.40€
S21H41125	1/2"	125	Mate	5.30€
S21H41250	1/2"	250	Mate	8.20€



S22H

Cabo articulado

Ref.	Quadra	Medida (mm)	Acabamento	Preço
S22H21150	1/4"	150	Mate	7.30€
S22H31200	3/8"	200	Mate	9.40€
S22H41375	1/2"	375	Mate	18.50€
S22H41450	1/2"	450	Mate	21.70€



Novo S22H

Cabo articulado

Ref.	Quadra	Comp. (mm)	Preço
S22H313T	3/8"	215~340	30.50€
S22H424T	1/2"	380~610	45.40€



Novo R70

Cabo com articulação dupla e roquete

Ref.	Quadra	Comp. (mm)	Preço
R7012	1/4"	200	36.00€
R7013	3/8"	300	36.40€



S22H

Cabo articulado

Ref.	Quadra	Medida (mm)	Acabamento	Preço
S22H41600	1/2"	600	Polido	31.70€
S22H6500	3/4"	500	Polido	43.50€



S22H41600RK

12.60€

Kit de reparação para cabo articulado S22H41600



S22H6500RK

18.40€

Kit de reparação para cabo articulado S22H6500



S22H21130RK

4.50€

Kit de reparação para cabo articulado S22H21130 e S22H21150



S22H41375RK

4.00€

Kit de reparação para cabo articulado S22H41375 e S22H41450



S22H31200RK

3.70€

Kit de reparação para cabo articulado S22H31200

S23H

Cabo "T" correção

Ref.	Quadra	Medida (mm)	Acabamento	Preço
S23H21115	1/4"	115	Mate	2.30€
S23H31200	3/8"	200	Mate	5.10€
S23H41250	1/2"	250	Mate	7.30€
S23H41300	1/2"	300	Mate	8.10€
S23H6450	3/4"	450	Polido	26.40€
S23H6500	3/4"	500	Polido	28.40€
S23H8550	1"	550	Polido	54.20€



S24H

Extensões

Ref.	Quadra	Medida (mm)	Acabamento	Preço
S24H250	1/4"	50	Mate	1.30€
S24H375	3/8"	75	Mate	2.10€
S24H450	1/2"	50	Mate	2.90€
S24H475	1/2"	75	Mate	3.50€
S24H2100	1/4"	100	Mate	1.50€
S24H2150	1/4"	150	Mate	1.90€
S24H3150	3/8"	150	Mate	3.00€
S24H3200	3/8"	200	Mate	3.50€
S24H3250	3/8"	250	Mate	4.40€
S24H4125	1/2"	125	Mate	4.40€
S24H4224	1/2"	610	Polido	27.80€
S24H4250	1/2"	250	Mate	5.20€
S24H6100	3/4"	100	Polido	12.30€
S24H6200	3/4"	200	Polido	16.50€
S24H6400	3/4"	400	Polido	27.90€
S24H8200	1"	200	Polido	30.80€



S26H2150
3.10€

Punho de 1/4"

S26H2280
15.50€

Punho 1/4" dupla função fixo/ cardan

AG010184F
7.00€

Chave flexível ponta macho de 1/4"

AG0101

Chave flexível de punho com caixa

Ref.	Medida (mm)	Preço
AG010184B	6	7.80€
AG010184C	7	7.80€
AG010184D	8	7.80€
AG010184E	10	7.80€

S27H

Extensões flexíveis

Ref.	Quadra	Medida (mm)	Preço
S27H2	1/4"	145	3.60€
S27H3	3/8"	193	21.50€
S27H4	1/2"	205	22.50€

S40H

Chave em T

Ref.	Medida (mm)	Comp. (mm)	Comp. Punho (mm)	Preço
S40H108	8	300	200	11.90€
S40H110	10	300	200	11.90€
S40H112	12	300	200	11.90€
S40H114	14	300	200	11.90€

S40T

Chave em T com ponta flexível



Ref.	Medida (mm)	Comp. (mm)	Preço
S40T108	8	435	26.00€
S40T110	10	435	26.00€
S40T112	12	435	26.00€
S40T113	13	435	26.20€
S40T114	14	435	26.70€
S40T117	17	435	26.70€
S40T119	19	435	27.80€

S40TB-1
5.00€

Travessa para S40T

S40T109S
163.60€

Jogo de 9 peças "T" flexíveis

Comprimento: 435mm

Composição/ medidas em mm:

8; 10; 12; 13; 14; 17 e 19

S41H41
13.70€

Manivela quadra macho de 1/2"

S42M

Extensões magnéticas



Ref.	Quadra	Medida (mm)	Preço
S42M475	1/2"	75	10.90€
S42M4125	1/2"	125	11.00€
S42M4250	1/2"	250	15.50€

S42M403S
39.50€

Jogo de 3 extensões magnéticas 1/2"

Composição/ medidas em mm:

75; 125 e 250



S44H2206

1.20€

Porta bits 1/4"

Quadra de 1/4" para uso em bits com encabadouro de 1/4"



S44H3110A

3.30€

Porta bits

Quadra: 3/8"
Utilização em bits: 3/8"



S44H3206

2.70€

Porta bits

Quadra: 3/8"
Utilização em bits: 1/4"



S44H4110

2.10€

Porta bits

Quadra: 1/2"
Utilização em bits: 3/8"



S60H4304S

48.80€

Jogo de 4 extensões de 1/2"

Composição/ medidas em mm:
75; 125; 250 e 375



R53A-3

Adaptador "macho/macho"

Para aplicação em conjunto com o cabo "T" flexível R53A

Ref.	Quadra	Compr. (mm)	Preço
R53A-2A	1/4"	20	1.30€
R53A-3A	3/8"	30	1.90€
R53A-4A	1/2"	35	2.50€



R19H310S

51.30€

Jogo de 10 chaves pata de galo de 3/8"

Composição/ medidas em mm:
Chaves: 10; 11; 12; 13; 14; 15; 16; 17; 18 e 19



R19H3

Chave pata de galo 3/8"

Ref.	Medida (mm)	Preço
R19H3110	10	5.80€
R19H3111	11	5.80€
R19H3112	12	5.80€
R19H3113	13	5.80€
R19H3114	14	5.80€
R19H3115	15	5.80€
R19H3116	16	6.10€
R19H3117	17	6.20€
R19H3118	18	5.90€
R19H3119	19	6.40€



S03A4111S

44.00€

Jogo de 11 chaves de impacto de 1/2"

Composição/ medidas (mm):
S03A4 Chaves: 10; 11; 12; 13; 14; 16; 17; 19; 21; 22 e 24



S01U41

Cardan de impacto 1/2"

Ref.	Medida (mm)	Compr. (mm)	Preço
S01U4113	13	70	14.10€
S01U4114	14	70	14.20€
S01U4115	15	70	14.20€
S01U4116	16	70	14.20€
S01U4117	17	70	14.20€
S01U4119	19	70	15.30€
S01U4121	21	70	16.00€
S01U4122	22	70	16.70€



S01U4108S

127.20€

Jogo 8 chaves/ cardans impacto 1/2"

Composição/ medidas em mm:
Chaves: 13; 14; 15; 16; 17; 19; 21 e 22



S03A2

Chave de impacto 1/4"



Ref.	Quadra	Medida (mm)	Preço
S03A2110	1/4"	10	1.90€
S03A2112	1/4"	12	2.00€
S03A2114	1/4"	14	2.10€

S03AD4111S

68.80€

Jogo de 11 chaves de impacto longas de 1/2"

Composição/ medidas (mm):

S03AD4 Chaves: 10; 11; 12; 13; 14; 16; 17; 19; 21; 22 e 24

S03A4A

Adaptador de 1/2"



Ref.	Quadra	Preço
S03A4A3	3/8"	4.90€
S03A4A6	3/4"	6.90€

S03A4U4

12.90€

Cardan de 1/2"

S03A4UT3S

39.40€

Jogo de 3 cardans impacto

Composição/ medidas:

1/4"; 3/8" e 1/2"

S03A

Cardan de impacto



Ref.	Quadra	Preço
S03A2UT	1/4"	10.00€
S03A3UT	3/8"	12.30€
S03A4UT	1/2"	15.00€

S03A4E

Extensão



Ref.	Quadra	Medida (mm)	Preço
S03A4E4	1/2"	100	5.90€
S03A4E5	1/2"	125	6.40€
S03A4E6	1/2"	150	7.70€
S03A4E8	1/2"	200	8.70€

S03A4211S

48.20€

Jogo de 11 chaves impacto 1/2" SAE

Composição:

Ref.	Medida	Ref.	Medida
S03A4210	3/8"	S03AD4219	3/4"
S03A4211	7/16"	S03AD4221	13/16"
S03A4213	1/2"	S03AD4222	7/8"
S03A4214	9/16"	S03AD4224	15/16"
S03A4216	5/8"	S03AD4226	1"
S03A4217	11/16"		

S03AD4414S

110.10€

Jogo de 14 chaves longas impacto 1/2" SAE

Composição/ medidas:

Chaves: 3/8"; 7/16"; 1/2"; 9/16"; 5/8"; 11/16"; 3/4"; 13/16"; 7/8"; 15/16"; 1"; 1-1/16"; 1-1/8" e 1-1/4"

S03A6108S

98.00€

Jogo de 8 chaves de impacto de 3/4"

Composição/ medidas:

S03A6 Chaves: 26; 27; 29; 30; 32; 35; 36 e 38



S03AD6107S

141.90€

Jogo de 7 chaves de impacto longas de 3/4"

Composição/ medidas:

S03AD6 Chaves: 26; 27; 29;
32; 35; 36 e 38



S03AD6120S

300.40€

Jogo de 20 peças de impacto de 3/4"

Composição/ medidas em mm:

S03AD6 Chaves: 24; 27; 30; 32; 33; 34; 35; 36; 41 e 46
S03A4A6 Adaptador 1/2" - 3/4"
S03A8A6 Adaptador 1" - 3/4"
S03A6U6 Cardan 3/4"
S03A6E Extensão de 3/4" 250 mm
 Pinos
 O'ring



S03A4

Chave impacto 1/2"

Ref.	Medida (mm)	D1 (mm)	D2 (mm)	L (mm)	Preço
S03A4109	9	15	24	38	3.10€
S03A4110	10	17	24	38	3.10€
S03A4111	11	19	24	38	3.20€
S03A4112	12	20	24	38	3.20€
S03A4113	13	20,8	24	38	3.30€
S03A4114	14	22	24	38	3.30€
S03A4115	15	24	24	38	3.30€
S03A4116	16	24	24	38	3.60€
S03A4117	17	26	26	38	3.70€
S03A4118	18	26	27	38	3.80€
S03A4119	19	28	28	38	4.00€
S03A4120	20	30	30	38	4.10€
S03A4121	21	30	30	38	4.30€
S03A4122	22	32	30	38	4.50€
S03A4123	23	34	30	38	4.80€
S03A4124	24	34	30	43	5.20€
S03A4127	27	38	30	43	7.80€
S03A4129	29	40	30	48	8.20€
S03A4130	30	42	30	48	8.50€
S03A4132	32	44,6	30	48	8.90€

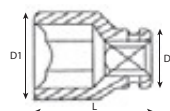

S03AD4
Chave impacto longa 1/2"



Ref.	Medida (mm)	D1 (mm)	D2 (mm)	L (mm)	Preço
S03AD4110	10	17	24	78	5.40€
S03AD4111	11	19	24	78	5.40€
S03AD4112	12	19,6	24	78	5.40€
S03AD4113	13	20,8	24	78	5.40€
S03AD4114	14	22	24	78	5.60€
S03AD4115	15	24	24	78	5.60€
S03AD4116	16	24	24	78	5.70€
S03AD4117	17	26	26	78	5.80€
S03AD4118	18	28	27	78	6.20€
S03AD4119	19	28	28	78	6.20€
S03AD4120	20	30	30	78	6.50€
S03AD4121	21	30	30	78	6.90€
S03AD4122	22	32	30	78	7.80€
S03AD4123	23	33,3	30	78	7.80€
S03AD4124	24	34,6	30	78	8.00€
S03AD4125	25	35,8	30	78	9.10€
S03AD4126	26	37	30	78	10.00€
S03AD4127	27	38	30	78	10.30€
S03AD4128	28	39,5	30	78	11.10€
S03AD4130	30	42	30	78	12.30€
S03AD4132	32	44,6	30	78	12.80€

S03AD6
Chave impacto longa 3/4"

Ref.	Medida (mm)	D1 (mm)	D2 (mm)	L (mm)	Preço
S03AD6124	24	38,9	44	90	17.80€
S03AD6126	26	41,3	44	90	19.10€
S03AD6127	27	42,6	44	90	19.10€
S03AD6129	29	45,1	44	90	19.50€
S03AD6130	30	46,4	44	90	19.90€
S03AD6132	32	48,9	44	90	20.30€
S03AD6133	33	50,6	44	90	21.00€
S03AD6134	34	51,4	44	90	21.20€
S03AD6135	35	52,7	44	90	21.40€
S03AD6136	36	53,9	44	90	22.30€
S03AD6138	38	56,4	44	90	25.20€
S03AD6140	40	58,9	44	90	28.30€
S03AD6141	41	60,1	44	90	30.00€
S03AD6142	42	61,4	44	90	31.80€
S03AD6144	44	64,8	44	90	36.00€
S03AD6146	46	66,4	44	90	36.70€
S03AD6150	50	71,4	54	90	43.50€

S03A6

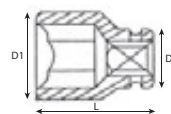
Chave impacto 3/4"



Ref.	Medida (mm)	D1 (mm)	D2 (mm)	L (mm)	Preço
S03A6126	26	41	38	51	8.40€
S03A6127	27	43	40	53	8.80€
S03A6129	29	45	42	53	9.40€
S03A6130	30	46	44	53	10.30€
S03A6132	32	49	44	57	10.40€
S03A6133	33	51	44	57	10.90€
S03A6134	34	51	44	57	11.30€
S03A6135	35	53	44	57	12.10€
S03A6136	36	54	44	57	12.70€
S03A6137	37	55	44	57	13.60€
S03A6138	38	56	44	57	13.70€
S03A6139	39	57,7	44	57	15.50€
S03A6140	40	59	44	57	16.80€
S03A6141	41	60	44	57	17.00€
S03A6142	42	61,4	44	57	19.10€
S03A6143	43	62,7	44	62	20.90€
S03A6144	44	64	44	62	21.20€
S03A6145	45	65	44	62	23.10€
S03A6146	46	66,4	44	62	23.20€
S03A6147	47	67,6	44	67	24.70€
S03A6148	48	68,8	44	67	25.10€
S03A6149	49	70	44	72	26.90€
S03A6150	50	71,4	72	72	27.70€
S03A6151	51	72,8	72	72	33.50€
S03A6152	52	74	72	72	34.00€
S03A6153	53	75	72	72	35.30€
S03A6154	54	76,4	72	72	35.80€
S03A6155	55	77,7	74	74	36.90€
S03A6156	56	79	74	74	41.20€
S03A6157	57	80	74	74	42.40€
S03A6158	58	81,5	75	75	45.30€
S03A6159	59	82,7	75	75	47.80€
S03A6160	60	84	75	75	47.40€
S03A6163	63	87,6	75	75	54.40€
S03A6165	65	90	78	78	54.10€
S03A6167	67	92,7	80	80	64.10€
S03A6170	70	96,4	83	83	66.00€

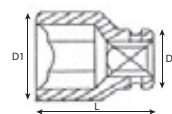

S03A8
Chave impacto 1"

Ref.	Medida (mm)	D1 (mm)	D2 (mm)	L (mm)	Preço
S03A8124	24	41,9	54	58	20.10€
S03A8127	27	45,6	54	58	20.60€
S03A8129	29	48,1	54	60	20.60€
S03A8130	30	49,4	54	60	20.60€
S03A8132	32	51,9	54	60	21.90€
S03A8133	33	53,6	54	60	22.20€
S03A8134	34	54,4	54	62	22.60€
S03A8135	35	55,7	54	62	22.60€
S03A8136	36	56,9	54	62	25.60€
S03A8138	38	59,4	54	65	26.00€
S03A8140	40	110	54	65	26.00€
S03A8141	41	63,1	54	65	25.70€
S03A8144	44	120	54	65	30.10€
S03A8146	46	69,4	54	74	30.10€
S03A8150	50	74,4	54	74	38.10€
S03A8155	55	80,7	54	85	46.10€
S03A8160	60	87,1	54	90	57.90€
S03A8165	65	93,2	54	90	72.50€
S03A8170	70	99,4	54	100	96.60€
S03A8173	73	103,3	86	100	102.80€
S03A8175	75	105,6	86	100	112.90€
S03A8176	76	106,9	86	100	130.00€
S03A8178	78	110	86	100	135.60€
S03A8180	80	111,9	86	100	140.00€
S03A8185	85	118,5	86	110	172.70€
S03A8189	89	123,2	86	110	175.20€
S03A8190	90	124,4	86	110	198.40€
S03A8192	92	126,8	86	110	206.50€
S03A8195	95	129	86	110	232.70€

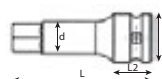
S05A4H
Bit hexagonal de impacto 1/2"

Ref.	Medida	D (mm)	d (mm)	L2 (mm)	L (mm)	Preço
S05A4H4	H4	25	6	22,5	78	8.80€
S05A4H5	H5	25	7	22,5	78	8.90€
S05A4H6	H6	25	8	22,5	78	9.00€
S05A4H7	H7	25	9	22,5	78	9.00€
S05A4H8	H8	25	10,5	22,5	78	9.10€
S05A4H10	H10	25	12,5	22,5	78	9.60€
S05A4H12	H12	25	15	22,5	78	9.60€
S05A4H14	H14	25	17,5	22,5	78	9.60€
S05A4H17	H17	25	21	22,5	78	9.60€
S05A4H18	H18	25	22	22,5	78	9.60€
S05A4H19	H19	25	23	22,5	78	9.60€

S03AD8

Chave impacto longa 1"

Ref.	Medida (mm)	D1 (mm)	D2 (mm)	L (mm)	Preço
S03AD8117	17	33,1	54	90	27.70€
S03AD8124	24	41,9	54	90	27.70€
S03AD8126	26	43,3	54	90	27.70€
S03AD8127	27	45,6	54	90	27.90€
S03AD8129	29	48,1	54	90	29.00€
S03AD8130	30	49,4	54	90	29.00€
S03AD8132	32	51,9	54	90	30.10€
S03AD8133	33	53,6	54	90	30.10€
S03AD8134	34	54,4	54	90	30.60€
S03AD8135	35	55,7	54	90	30.60€
S03AD8136	36	56,9	54	90	31.80€
S03AD8138	38	59,4	54	90	32.90€
S03AD8140	40	61,9	54	90	34.20€
S03AD8141	41	63,1	54	90	35.10€
S03AD8142	42	64,4	54	90	36.50€
S03AD8146	46	69,4	54	90	43.30€
S03AD8148	48	71,8	54	90	45.70€
S03AD8150	50	74,4	54	90	55.80€
S03AD8155	55	80,7	54	90	69.20€
S03AD8158	58	84,5	54	105	75.60€
S03AD8160	60	87,1	54	120	83.00€
S03AD8165	65	93,2	54	120	98.60€



S03A6A

Adaptador de 3/4"

Ref.	Quadra	Preço
S03A6A4	1/2"	13.40€
S03A6A8	1"	15.80€



S03A6U6

Cardan de 3/4"

41.70€



S03A6E

Extensão

Ref.	Quadra	Medida (mm)	Preço
S03A6E04	3/4"	100	21.40€
S03A6E08	3/4"	200	27.30€
S03A6E10	3/4"	250	29.70€



S03A8109S

234.00€

Jogo de 9 chaves impacto 1"

Composição/ medidas:

S03A8 Chaves: 24; 27; 30; 32; 35; 38; 41; 46 e 50



S03A8A6

Adaptador 1" - 3/4"

20.60€



S03A8E

Extensão impacto

Ref.	Quadra	Medida (mm)	Preço
S03A8E04	1"	100	32.20€
S03A8E07	1"	175	40.80€
S03A8E10	1"	250	61.00€



S03AD8107S

214.30€

Jogo de 7 chaves longas de impacto 1"

Composição/ medidas:

 S03AD8 17; 24; 27; 30; 34; 35 e 38mm
 Mala metálica

S03S8

Chave de impacto quadrada

Ref.	Quadra	Medida (mm)	Preço
S03S8117	1"	17	21.10€
S03S8119	1"	19	21.50€
S03S8121	1"	21	21.60€

S03SD8

Chave de impacto longa quadrada

Ref.	Quadra	Medida (mm)	Preço
S03SD8117	1"	17	28.70€
S03SD8119	1"	19	28.70€
S03SD8121	1"	21	30.40€

S05A408S

61.30€

Jogo de 8 chaves de caixa com ponta macho hexagonal de impacto 1/2"

Composição:

S05A4 Chaves: H5; H6; H8; h10; H12; H14; H17 e H19

S05A416S

76.80€

Jogo de 16 peças ponta macho hexagonal

Composição:

 8pcs: 8, 10, 12, 13, 14, 17, 19 mm
 7pcs: 5/16", 3/8", 7/16", 1/2", 9/16", 5/8", 3/4"
 1 Adaptador impacto 1/2"

S05A6105S

100.30€

Jogo de 5 bits hexagonais de impacto 3/4"

Composição:

S05A6 Chaves: 14; 17; 19; 22 e 24mm de 88mm

S05A6H

Chave de impacto hexagonal de 3/4"

Ref.	Medida (mm)	Comprimento (mm)	Preço
S05A6H14	14	88	18.60€
S05A6H17	17	88	19.00€
S05A6H19	19	88	19.00€
S05A6H22	22	88	19.00€
S05A6H24	24	88	19.00€

S06A4T

Chaves de caixa com ponta macho torx de impacto de 1/2"

Ref.	Medida	Preço
S06A4T20	T20	9.20€
S06A4T27	T27	9.20€
S06A4T30	T30	9.20€
S06A4T40	T40	9.20€
S06A4T45	T45	9.20€
S06A4T50	T50	9.20€
S06A4T55	T55	9.20€
S06A4T60	T60	10.50€
S06A4T70	T70	10.50€
S06A4T80	T80	10.50€

S06A408S

59.50€

Jogo de 8 chaves de caixa com ponta macho torx de impacto 1/2"

Composição:

S06A4 Chaves: T30; T40; T45; T50; T55; T60; T70 e T80

S64A4106S

53.50€

Jogo de 6 chaves de impacto XZN de 1/2"

Composição:

 S064A4 3 Chaves: M14; M16 e M18 de 45mm
 3 Chaves: M14; M16 e M18 de 76mm

Ferramenta de aperto

S64A61

Chave de impacto perfil XZN de 3/4"

Ref.	Medida	Comprimento (mm)	Preço
S64A6116	M16	61	14.30€
S64A6118	M18	61	14.30€



S64A6306S

90.90€

Jogo de 6 chaves de impacto XZN e Torx de 3/4"

Composição:

S064A6 4 Chaves Torx:
T70; T80; T90 e T100 de 61mm
2 Chaves XZN:
M16 e M18 de 61mm



S64A6T

Chave de impacto perfil Torx de 3/4"

Ref.	Medida	Comprimento (mm)	Preço
S64A6T70	T70	61	12.80€
S64A6T90	T90	61	13.70€



S12A4525S

253.30€

Jogo de 25 chaves impacto magnéticas de 1/2"

Composição:

Chaves de 1/2": 3/8"; 7/16"; 1/2"; 9/16"; 5/8"; 11/16";
3/4"; 13/16"; 7/8"; 15/16" e 1"
Chaves de 1/2": 10 a 21mm
Cardan de 1/2"
Extensão 80mm



S18A4117M

25.10€

Chave impacto magnética de 17 mm de 1/2"



S18A4119M

20.30€

Chave impacto magnética de 19 mm de 1/2"



S18A4121M

20.30€

Chave impacto magnética de 21 mm de 1/2"



S18A4103MS

74.10€

Jogo de 3 chaves impacto magnéticas de 1/2"

Composição:

Chaves: 17; 19 e 21mm



S03AD4317

9.60€

Chave impacto de 17 mm de 1/2"



S03AD4319

9.70€

Chave impacto de 19 mm de 1/2"



S03AD4321

9.70€

Chave impacto de 21 mm de 1/2"



S03AD4303S

33.70€

Jogo de 3 chaves impacto de 1/2"

Composição:

Ref.	Medida (mm)
S03AD4317	17
S03AD4319	19
S03AD4321	21



S03AD4307S

90.20€

Jogo de 7 chaves impacto de 1/2"

Composição:

Ref.	Medida (mm)
S03AD4317	17
S03AD4319	19
S03AD4321	21
S03AD4322	22
S03AD4323	23
S03AD4324	24
S03AD4327	27



S18AD4103S
83.60€
Jogo 3 chaves impacto 1/2" extra longas

Composição:

Ref.

S18AD4117

S18AD4119

S18AD4121

S03AD4517
20.60€
Chave impacto longa de 17 mm de 1/2"

S03AD4519
20.90€
Chave impacto longa de 19 mm de 1/2"

S03AD4521
21.20€
Chave impacto longa de 21 mm de 1/2"

S46TE80
17.90€
Barra de torque 110Nm de 1/2"

Comprimento: 196mm

Cor: azul

S18A41
Chave de impacto longa para rodas

Ref.	Quadra	Medida (mm)	D (mm)	L (mm)	Cor	Preço
S18A4115	1/2"	15	25	85	Laranja	8.80€
S18A4117	1/2"	17	27	85	Azul	10.90€
S18A4119	1/2"	19	28,5	85	Verde	11.90€
S18A4121	1/2"	21	31	85	Vermelho	12.60€

S18AD41
Chave de impacto extra longa para rodas

Ref.	Quadra	Medida (mm)	D (mm)	L (mm)	Cor	Preço
S18AD4117	1/2"	17	27	150	Azul	21.50€
S18AD4119	1/2"	19	28,5	150	Verde	21.50€
S18AD4121	1/2"	21	31	150	Vermelho	21.50€

Alicates

com revestimento antideslizante

P018 21.40€

Alicate universal

Comprimento: 200mm



P6008 10.90€

Alicate regulável (2 posições)

Comprimento: 200mm



P27

Alicate ajustável

Ref.	Compr. (mm)	Preço
P2706	160	13.10€
P2710	250	19.40€
P2712	330	31.50€



P2810 19.40€

Alicate ajustável

Comprimento: 250mm



P038 17.00€

Alicate de corte diagonal

Comprimento: 200mm



P046 13.60€

Alicate de corte

Comprimento: 160mm



P068 16.60€

Alicate de pontas

Comprimento: 200mm
Capacidade máxima: Ø3,0mm



P068A 15.80€

Alicate de pontas

Comprimento: 200mm



P079 21.90€

Alicate universal

Comprimento: 220mm
Capacidade máxima: Ø3,0mm



JONNESWAY

P61

Alicate de corte frontal

Ref.	Compr. (mm)	Preço
P6106	160	13.90€
P6108	200	16.60€



P16

Alicate de freios interiores (pontas direitas)

Ref.	Compr. (mm)	Preço
P16507	170	19.90€
P16509	215	34.40€



P16

Alicate de freios interiores (pontas curvas 90°)

Ref.	Compr. (mm)	Preço
P16517	170	19.90€
P16519	215	34.40€



P16

Alicate de freios exteriores (pontas direitas)

Ref.	Compr. (mm)	Preço
P16527	170	19.90€
P16529	215	34.40€



P16

Alicate de freios exteriores (pontas curvas 90°)

Ref.	Compr. (mm)	Preço
P16537	170	19.90€
P16539	215	34.40€



AG01000

Alicates de freios interiores (pontas direitas)

Ref.	Compr. (mm)	Preço
AG010002	175	12.50€
AG010003	230	17.60€

AG01000

Alicates de freios interiores (pontas curvas)

Ref.	Compr. (mm)	Preço
AG010005	175	12.80€
AG010006	230	17.80€

AG01000

Alicates de freios exteriores (pontas direitas)

Ref.	Compr. (mm)	Preço
AG010008	175	12.70€
AG010009	230	17.90€

AG01000

Alicates de freios exteriores (pontas curvas 90°)

Ref.	Compr. (mm)	Preço
AG010011	175	12.80€
AG010012	230	17.90€

AG010002S

58.50€

Jogo de 4 alicates de freios

Composição:

AG010002 Alicates de freios interiores com pontas direitas

AG010005 Alicates de freios interiores com pontas curvas

AG010008 Alicates de freios exteriores com pontas direitas

AG010011 Alicates de freios exteriores com pontas curvas

Alicates

com revestimento antideslizante e mola

P9806A

9.90€

Novo

Alicates de corte lateral 5"

Adequado para fio de cobre abaixo do diâmetro 1,3mm

Para corte delicado (eletrónica)

P9512

44.30€

Alicates de pontas longas

Comprimento: 300mm

P9508C

22.60€

Alicates de freios interiores (pontas curvas)

Comprimento: 216mm

Capacidade: 10-32mm

P9508D

22.60€

Alicates de freios exteriores (pontas curvas)

Comprimento: 216mm

Capacidade: 10-32mm

P9506

18.20€

Alicates corta fios

Comprimento: 165mm

Peso: 188g

P9006

21.50€

Alicates pontas chatas

Comprimento: 160mm

P8606

22.70€

Alicates de corte diagonal

Comprimento: 160mm



Alicates

com revestimento antideslizante e mola

P8106

21.60€

Alicate pontas longas

Comprimento: 160mm



P7101

22.60€

Mini alicate de pontas curvas 45° (desenho ergonómico)

Comprimento: 140mm

Peso: 90g



P7102

22.00€

Mini alicate de corte frontal (desenho ergonómico)

Comprimento: 110mm

Peso: 90g



P7103

19.10€

Mini alicate de corte diagonal (desenho ergonómico)

Comprimento: 115mm

Peso: 90g



P7104

19.40€

Mini alicate universal (desenho ergonómico)

Comprimento: 120mm

Peso: 90g



P7105

19.80€

Mini alicate de pontas direitas (desenho ergonómico)

Comprimento: 135mm

Peso: 90g



P8006

23.20€

Alicate universal

Comprimento: 160mm



P9920-BT

14.90€

Pontas curvas (par)



P9920-ST

13.10€

Pontas direitas (par)



P9902S

310.10€

Jogo de 2 alicate de freios

Composição:

P9920A Alicate de freios internos

P9920C Alicate de freios externos

Capacidade: 165-300mm



P266

14.70€

Alicate de freios internos e externos (pontas intermutáveis)

Capacidade: freios de 12 a 50mm

Pontas de: Ø1,2 e 1,5mm

Pontas direitas de: 45 e de 90°



com revestimento antideslizante

Símbolo				
Tipo de material	Macio	Dureza média	Duro	Corda de piano
Exemplo	Cobre, alumínio	Ferro	Aço	Aço duro/ mola
Tensão N/mm ²	220-250	750-800	1700-1800	2200-2300





P051
Alicate corta cabos

Ref.	Compr. (mm)	mm ²	Ø mm	Preço
P0516	160	22	9.5	19.60€
P0518	200	38	11.5	22.90€

P0118
Alicate universal

Ref.	Compr. (mm)					Preço
P0118	200	5.0	3.5	2.4	2.0	21.90€

P081
Alicate universal

Ref.	Compr. (mm)					Preço
P0816	160	4.0	2.8	1.8	1.4	16.00€
P0817	180	4.0	3.0	2.0	1.6	17.50€
P0818	200	4.0	3.0	2.0	1.6	19.90€





P091
Alicate de corte (trabalho intensivo)

Ref.	Compr. (mm)					Preço
P0916	160	4.0	3.0	2.0	1.6	18.30€
P0917	180	5.0	3.5	2.4	2.0	19.90€
P0918	200	5.0	3.5	2.4	2.0	21.60€





P101
Alicate de corte

Ref.	Compr. (mm)					Preço
P1016	160	4.0	3.0	2.0	1.6	16.40€
P1017	180	4.0	3.0	2.0	1.6	18.40€

P111
Alicate de pontas

Ref.	Compr. (mm)					Preço
P1116	160	4.0	2.8	1.8	1.4	15.40€
P1118	200	4.0	3.0	2.0	1.6	18.00€

P121
Alicate de pontas curvas

Ref.	Compr. (mm)					Preço
P1216	160	4.0	2.8	1.8	1.4	16.70€
P1218	200	4.0	3.0	2.0	1.6	19.60€

P1416
Alicate de pontas chatas

Comprimento: 160mm



15.80€

P1516
Alicate de descarnar

Comprimento: 160mm



17.30€

P4016
Alicate de pontas redondas

Comprimento: 160mm



16.00€

P6118
Alicate de corte frontal

Ref.	Compr. (mm)	Preço
P6118	180	19.70€

P2811
Alicate ajustável

Ref.	Compr. (mm)	Preço
P28110	240	24.10€
P28112	300	34.20€

P2821
Alicate ajustável

Ref.	Compr. (mm)	Preço
P28210	240	29.50€
P28212	300	42.80€

Alicates

com revestimento antideslizante

P08104S

92.40€

Jogo de 4 alicates

Composição:

P0817 Alicates universal

P0917 Alicates de corte diagonal

P1118 Alicates de pontas direitas

P28210 Alicates de ajustável



PESD05

12.90€

Alicates anti-estático pontas curvas (com mola)

Comprimento: 150mm



PESD10

12.10€

Alicates anti-estático de corte (com mola)

Comprimento: 115mm



PESD11

12.50€

Alicates anti-estático de pontas (com mola)

Comprimento: 130mm



P178

20.30€

Turquês de carpinteiro

Comprimento: 200mm



P1810

19.50€

Turquês de cofragens

Comprimento: 250mm



P2010LA

16.60€

Tesoura articulada

Corte esquerda

Comprimento: 250mm

Peso: 395g

Capacidade de corte: Aço: 1,2mm | Aço inox: 0,7mm



P2010RA

16.90€

Tesoura articulada

Corte direita

Comprimento: 250mm

Peso: 395g

Capacidade de corte: Aço: 1,2mm | Aço inox: 0,7mm



P2010SA

17.10€

Tesoura articulada

Lâminas direitas

Comprimento: 200mm



P22

Tesoura de cortar chapa

Ref.	Compr. (mm)	Preço
P2208A	205	14.90€
P2212A	305	26.70€

P2208A

205

14.90€

P2212A

305

26.70€



P2205E

16.10€

Tesoura de electricista



P15808

17.30€

Tesoura multifunções

Lâminas em aço inox de 3mm

Comprimento: 206mm



P43

Alicates corta cabos

Ref.	Compr. (mm)	Peso	Capac. de corte	Preço
P4318	450	1 570g	fio 5mm cabo 10mm	50.10€
P4330	750	4 200g	fio 9mm cabo 14mm	94.60€

P4318

450

1 570g

fio 5mm
cabo 10mm

50.10€

P4330

750

4 200g

fio 9mm
cabo 14mm

94.60€



P4318-RK

23.80€

Kit de reparação

P4330-RK

48.20€

Kit de reparação

P6424

49.00€

Alicate corta cabos

Comprimento: 600mm
Peso: 2 700g
Capacidade de corte: Ø 10mm



P7601

25.70€

Alicate longo de pontas direitas

Comprimento: 275mm



P7602

24.00€

Alicate longo de pontas curvas 45°

Comprimento: 275mm



P7603

25.60€

Alicate longo de pontas curvas 90°

Comprimento: 275mm



P7608

25.50€

Alicate longo de pontas redondas Ø13mm

Comprimento: 275mm



P7719

43.60€

Alicate longo de torcer arame

Comprimento: 270mm
Peso: 360g
Capacidade: Ø 0,55mm



V1001

20.80€

Alicate de rebitar (trabalho intensivo)

Inclui 4 bicos: 2,4; 3,2; 4 e 4,8mm



V1002

68.00€

Alicate de rebitar extensível

Inclui 4 bicos: 2,4; 3,2; 4 e 4,8mm



V1002-RK

2.50€

Kit de reparação para alicate de rebitar extensível V1002



Alicates

V1003

55.80€

Alicate de rebitar (trabalho intensivo)

Inclui bicos: 6,4; 3,2; 4 e 4,8mm



V1003-RK

5.70€

Kit de reparação para alicate de rebitar V1003



V1005

30.10€

Alicate de rebitar (bicos intermutáveis)

Inclui bicos: 2,4; 3,2; 4 e 4,8mm



V21

Alicate de rebitar (bicos intermutáveis)

Ref.	Bicos (mm)	Preço
V2101	2,4; 3,2; 4 e 4,8 mm	41.70€
V2102	3,2; 4; 4,8 e 6,4 mm	54.40€



V2102-RK

6.20€

Kit de reparação para alicate de rebitar V2102



V1103

54.90€

Alicate de rebitar fêmeas

Capacidade: M3; M4; M5 e M6



V2401

75.90€

Alicate de rebitar fêmeas

Capacidade: M5; M6; M8 e M10



V2401

Mandril

Ref.	Medida	Preço
V2401-M5A	M5	4.10€
V2401-M6A	M6	4.10€
V2401-M8A	M8	4.10€
V2401-M10A	M10	4.10€



Alicates

V2401

Bico

Ref.	Medida	Preço
V2401-M5B	M5	4.30€
V2401-M6B	M6	4.30€
V2401-M8B	M8	4.30€
V2401-M10B	M10	4.30€



AR030058

136.00€

Alicate de cravar terminais

Intermutável para 6 tipos de terminais



V1311

Alicate de cravar terminais

Ref.	Caraterísticas	Preço
V1311A	Terminais isolados	48.30€
V1311C	Fichas cabo coaxial	55.40€
V1311E	Terminais não isolados	50.00€
V1310F	Fichas RJ45	52.70€

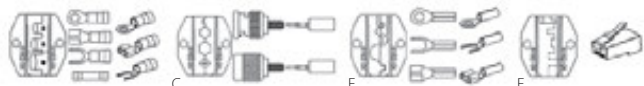

V1310

Accessórios para alicate de cravar V1310

Ref.	Terminais	Preço
V1310A-11	Mordentes	17.30€
V1310B-11	Mordentes	17.30€
V1310E-11	Mordentes	17.80€
V1310F-11	Mordentes RJ45	24.00€
V1310G-11	Mordentes AWG 22-10 (0,5-10mm ²)	22.50€
V1310J-11	Mordentes AWG 10-60 (6-16mm ²)	24.10€

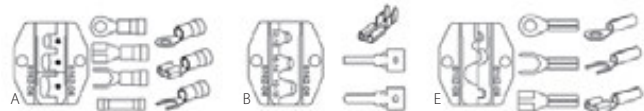

AR030022

86.80€

Jogo de 530 terminais auto com 18 tipos



V1401

12.00€

Alicate de cravar terminais/ descarnar fios



V1403

22.50€

Alicate de cravar (trabalho intensivo)



V1501

28.30€

Alicate de descarnar (trabalho intensivo)

Parafuso de ajuste à espessura do fio

Comprimento: 172mm

Peso: 305g



V1505

22.60€

Alicate de descarnar



P30M10A

15.80€

Alicate de pressão bicos direitos

Comprimento: 250mm

Peso: 540g



P32M

Alicate de pressão bocas côncavas

Ref.	Compr. (mm)	Preço
P32M07A	180	13.90€
P32M10A	250	15.40€



P36M09A

14.50€

Alicate de pressão bicos longos

Comprimento: 230mm



P36M

Alicate de pressão tipo pistola

Ref.	Compr. (mm)	Preço
P36M01P	28	32.40€
P36M02P	48	32.40€





P37M

Alicate de pressão pescoço de cisne

Ref.	Compr. (mm)	Preço
P37M11A	280	26.30€
P37M18A	450	45.20€



P38M

Alicate de pressão para soldadura

Ref.	Compr. (mm)	Preço
P38M09A	230	22.60€
P38M11A	280	28.00€

P52A10

Alicate de pressão boca direita ajustável

Comprimento: 250mm



50.00€

P52B10

Alicate de pressão boca curva ajustável

^AComprimento: 250mm



44.00€

P52C10

Alicate de pressão boca curva ajustável

Comprimento: 250mm



56.00€

P52D12

Alicate de pressão boca longa ajustável

Comprimento: 300mm



52.40€

P52M10

Alicate de pressão bocas recurvadas

Comprimento: 250mm



20.90€

Alicates



P53M

Alicate pescoço cisne maxilas oscilantes

Ref.	Compr. (mm)	Preço
P53M06	152	16.20€
P53M11	280	28.80€
P53M18	460	46.90€

P54M

Alicate de pressão para latoeiros



Ref.	Compr. (mm)	Preço
P54M08A	205	19.80€
P54M10A	250	26.00€

P52N10

Alicate de pressão boca larga

Comprimento: 240mm



27.60€

P1019

Alicate de pressão com corrente

Comprimento: 230mm

Capacidade: 457mm



24.10€

P9409

Alicate de pressão



26.30€

P30M07C

Alicate de pressão isolado

Comprimento: 175mm

Peso: 360g



16.90€

P32M

Alicate de pressão isolado com mordentes curvos e corta fios

Ref.	Compr. (mm)	Peso (g)	Preço
P32M05C	125	175	14.70€
P32M10C	250	560	20.20€



P36M

Alicate de pressão isolado bicos longos com corta fios

Ref.	Compr. (mm)	Peso (g)	Preço
P36M06C	152	180	15.20€
P36M09C	270	560	17.70€



P78M10C

21.70€

Alicate de pressão isolado
Comprimento: 250mm



P32M03S

51.10€

Jogo de 3 alicates de pressão

Ref.	Caraterísticas	Compr. (mm)
P36M06S	Bicos longos	160
P32M07S	Bocas côncavas	180
P32M10S	Bocas côncavas	250



P7801

33.40€

Alicate de pressão multifunções
Garras tipo W



P7802

33.40€

Alicate de pressão multifunções
Garras tipo JJ



P7803

32.10€

Alicate de pressão multifunções
Garras tipo LL



P7804

31.70€

Alicate de pressão multifunções
Garras tipo J



P7805

34.40€

Alicate de pressão multifunções





D70S

Chaves fenda de impacto

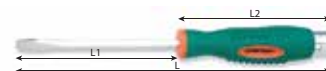

Ref.	Medida (mm)	L1 (mm)	L2 (mm)	L (mm)	Preço
D70S475	4	75	107	182	4.40€
D70S5100	5,5	100	107	207	5.70€
D70S6125	6,5	125	127	252	7.20€
D70S6150	6,5	150	127	277	7.50€
D70S8150	8	150	144	294	8.90€
D70S8175	8	175	144	319	9.10€
D70S9175	9,5	175	144	319	10.70€
D70S9250	9,5	250	144	394	11.50€



D70P

Chave phillips de impacto

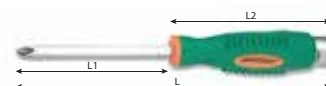

Ref.	Medida	L1 (mm)	L2 (mm)	L (mm)	Preço
D70P175	PH1	75	107	182	5.50€
D70P2100	PH2	100	127	277	6.50€
D70P3125	PH3	125	144	269	9.50€
D70P3150	PH3	150	144	299	9.90€



D71P

Chave phillips

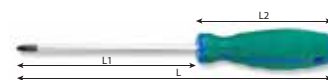

Ref.	Medida	L1 (mm)	L2 (mm)	L (mm)	Preço
D71P060	PH0	60	90	150	3.20€
D71P138	PH1	38	56	94	3.10€
D71P180	PH1	80	110	190	3.60€
D71P238	PH2	38	56	94	2.90€
D71P1100	PH1	100	110	210	3.80€
D71P1150	PH1	150	110	250	4.20€
D71P1300	PH1	300	110	410	5.60€
D71P2100	PH2	100	119	219	4.30€
D71P2150	PH2	150	119	269	4.50€
D71P2250	PH2	250	119	369	7.10€
D71P2400	PH2	400	119	519	8.20€
D71P3150	PH3	150	129	279	6.40€
D71P3250	PH3	250	129	279	8.50€
D71P3400	PH3	400	129	529	11.00€
D71P4200	PH4	200	129	329	7.60€



D71S

Chave fenda

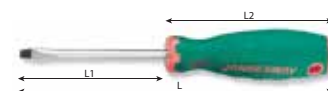

Ref.	Medida (mm)	L1 (mm)	L2 (mm)	L (mm)	Preço
D71S250	2,4	50	72	122	2.60€
D71S360	3	60	72	132	3.00€
D71S4100	4	100	90	190	3.10€
D71S4150	4	150	110	260	3.90€
D71S4200	4	200	90	290	4.40€
D71S480	4	80	90	170	3.00€
D71S5125	5,5	125	110	235	3.50€
D71S5200	5,5	200	110	310	4.20€
D71S5300	5,5	300	110	410	5.50€
D71S538	5,5	38	56	94	3.00€
D71S575	5,5	75	110	185	3.60€
D71S638	6,5	38	56	94	3.00€
D71S6100	6,5	100	119	219	4.40€
D71S6150	6,5	150	119	269	4.50€
D71S6400	6,5	400	119	519	8.90€
D71S8150	8	150	129	279	5.80€
D71S8200	8	200	129	329	6.50€
D71S8300	8	300	129	429	8.80€
D71S8500	8	500	129	629	12.40€
D71S9175	9,5	175	129	304	6.80€
D71S10250	10	250	129	379	7.60€

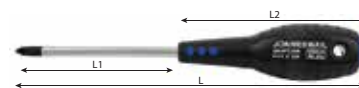
D04P
Chave phillips

Ref.	Medida	L1 (mm)	L2 (mm)	L (mm)	Preço
D04P180	PH1	80	94	174	3.30€
D04P2100	PH2	100	112	212	4.00€
D04P3150	PH3	150	123	273	6.00€

D04S
Chave fenda

Ref.	Medida	L1 (mm)	L2 (mm)	L (mm)	Preço
D04S480	4	80	90	170	3.30€
D04S5125	5,5	125	95	220	3.50€
D04S6100	6,5	100	112	212	4.60€
D04S6150	6,5	150	110	260	4.60€

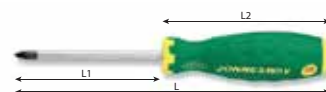
D71Z
Chave pozi

Ref.	Medida	L1 (mm)	L2 (mm)	L (mm)	Preço
D71Z060	PZ0	60	90	150	3.10€
D71Z138	PZ1	38	56	94	3.10€
D71Z180	PZ1	80	110	190	3.50€
D71Z2100	PZ2	100	119	219	4.40€
D71Z3150	PZ3	150	129	279	6.20€
D71Z4200	PZ4	200	129	329	7.80€

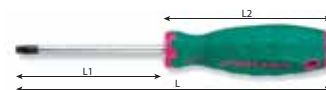
D71T
Chave torx

Ref.	Medida	L1 (mm)	L2 (mm)	L (mm)	Preço
D71T5	T5	60	73	132	2.70€
D71T6	T6	60	73	132	2.70€
D71T7	T7	60	73	132	2.60€
D71T8	T8	60	73	132	2.90€
D71T9	T9	60	73	132	2.90€
D71T10	T10	80	90	170	3.00€
D71T15	T15	80	90	170	3.00€
D71T20	T20	100	110	210	3.60€
D71T25	T25	100	110	210	3.60€
D71T27	T27	100	119	219	4.80€
D71T30	T30	125	119	244	5.00€
D71T40	T40	150	129	279	6.30€
D71T45	T45	200	129	329	6.40€
D71T50	T50	200	129	329	7.50€

D715N
Chave caixa com punho

Ref.	Medida	L1 (mm)	L2 (mm)	L (mm)	Preço
D715N05	5	125	119	244	6.30€
D715N07	7	125	119	244	6.40€
D715N08	8	125	119	244	6.40€
D715N10	10	125	119	244	7.10€
D715N12	12	125	119	244	7.10€
D715N13	13	125	119	244	7.50€

D70PP07S

54.40€

Jogo de 7 chaves fenda/ phillips de impacto

Composição/ medidas (mm):

3 Chaves fenda impacto: 5,5x100; 6,5x125 e 8x150

3 Chaves phillips: PH1x75; PH2x100 e PH3x125

1 Chave extensível com ponta magnética



D70PP10S

75.80€

Jogo de 10 chaves fenda/ phillips de impacto

Composição/ medidas (mm):

D70S Chaves fenda: 5,5x100; 6,5x125; 8x150; 9,5x175 e 6,5x38

D70P Chaves phillips: PH1x75; PH2x100; PH3x125 e PH2x38

Ponteiro magnético



D71400T

Chave torx longa

Ref.	Medida	Compr. (mm)	Preço
D71400T10	T10	400	7.40€
D71400T15	T15	400	8.00€
D71400T20	T20	400	8.70€
D71400T25	T25	400	9.30€
D71400T27	T27	400	10.20€
D71400T30	T30	400	11.20€



DV15PP-TP

4.50€

Busca-polos

220 - 250 v



AR030005

8.40€

Teste de circuito check-point



D725N

Chaves "T" de punho antideslizante com caixa sextavada

Ref.	Medida (mm)	Compr. (mm)	Preço
D725N06	6	298	7.40€
D725N07	7	298	7.40€
D725N08	8	298	7.40€
D725N09	9	298	7.50€
D725N10	10	298	7.50€
D725N11	11	298	7.60€
D725N12	12	298	7.90€
D725N13	13	298	7.90€



D71C105S

20.20€

Jogo de 5 chaves fenda/ phillips

Composição/ medidas (mm):

Chaves fenda: 4x80; 5,5x125 e 6,5x150

Chaves phillips: PH1x80 e PH2x100



D71C106S

23.20€

Jogo de 6 chaves fenda/ phillips

Composição/ medidas (mm):

Chaves fenda: 3x60; 5,5x125 e 6,5x150

Chaves phillips: PH0x60; PH1x80 e PH2x100



D71PP08S

42.30€

Jogo de 8 chaves fenda/ phillips com punho antideslizante

Composição/ medidas (mm):

D71S Chaves fenda: 6,5x38; 4x80; 5,5x125 e 6,5x150

D71P Chaves phillips: PH2x38; PH1x80; PH2x100 e PH3x150



D71PP16S
90.70€
Jogo de 16 chaves fenda/ phillips com punho antideslizante

Composição/ medidas (mm):

D71S Chaves fenda: 6,5x38; 3x50; 6,5x100; 5,5x125; 5,5x200; 8,5x150; 5,5x75 e 4x150

D71P Chaves phillips: PH2x38; PH1x150; PH0x60; PH1x80; PH2x100; PH2x150; PH3x150 e PH1x38

D71T107S
32.20€
Jogo de 7 chaves torx com punho antideslizante

Composição/ medidas (mm):

Chaves: T10; T15; T20; T25; T27; T30 e T40

D71T109S
37.30€
Jogo de 9 chaves torx com punho antideslizante

Composição/ medidas (mm):

Chaves: T8; T9; T10; T15; T20; T25; T27; T30 e T40

D71Z105S
20.30€
Jogo de 5 chaves fenda/ pozi

Composição/ medidas (mm):

Chaves fenda: 4x80; 5,5x125 e 6,5x150

Chaves pozi: PZ1x80 e PZ2x100

D71Z107S
36.20€
Jogo de 7 chaves fenda/ pozi com punho antideslizante

Composição/ medidas (mm):

Chaves fenda: 4x100; 5,5x125; 6,5x150 e 8x175

Chaves pozi: PZ1x80; PZ2x100 e PZ3x150

D3750P08S
27.90€
Jogo de 8 chaves de precisão fenda/ phillips

Composição:

Ref.	Chave	Ponta (mm)	Compr. (mm)
D3750S30	fenda	3	50
D3750S24	fenda	2,4	50
D3750S20	fenda	2	50
D3750S16	fenda	1,6	50
D3750S10	fenda	1	50
D3750P1	phillips	nº1	50
D3750P0	phillips	nº0	50
D3750P00	phillips	nº00	50

D3750T08S
26.10€
Jogo de 8 chaves de precisão torx

Composição:

Ref.	Medida (mm)	Ref.	Medida (mm)
D3750T20	T20x50	D3750T8	T8x50
D3750T15	T15x50	D3750T7	T7x50
D3750T10	T10x50	D3750T6	T6x50
D3750T9	T9x50	D3750T5	T5x50



D3750P

Chave de precisão phillips

Ref.	Medida (mm)	Preço
D3750P0	PH0x50	2.30€
D3750P00	PH00x50	2.30€
D3750P1	PH1x50	2.30€



D3750S

Chave de precisão fenda

Ref.	Medida (mm)	Preço
D3750S10	1x50	2.40€
D3750S16	1,6x50	2.40€
D3750S20	2x50	2.40€
D3750S24	2,4x50	2.40€
D3750S30	3x50	2.40€



D3750T

Chave de precisão torx

Ref.	Medida (mm)	Preço
D3750T5	T5x50	2.40€
D3750T6	T6x50	2.40€
D3750T7	T7x50	2.40€
D3750T8	T8x50	2.40€
D3750T9	T9x50	2.40€
D3750T10	T10x50	2.40€
D3750T15	T15x50	2.40€
D3750T20	T20x50	2.40€



D3750T18S

25.00€

Jogo de 8 chaves de precisão

Composição:

Ref.	Medida (mm)	Ref.	Medida (mm)
D3750P00	P00x50	D3750T7	T7x50
D3750T4	T4x50	D3750A1	garfo 50
D3750T5	T5x50	D3750A2	inclinação 50
D3750T6	T6x50	D3750A3	agulha 50



DR0107S

17.50€

Jogo de bits longos e porta bits

Composição/ medidas (mm):

Porta bits
Bits duplo 65mm
Pozi 1/ fenda 5mm
Pozi 2/ fenda 6mm
Pozi 3/ fenda 7mm
Hexagonal 3mm/ 4mm
Hexagonal 5mm/ 6mm
Phillips/ fenda 6mm



DR0253S

64.40€

Jogo de bits e porta bits flexível

Composição/ medidas (mm):

Porta bits flexível
Bits phillips: #1; #2 e #3
Bits fenda: 3; 4; 5,5; e 7
Bits pozi: #0; #1; #2; e #3
Bits hexagonal: 2; 2,5; 3; 4; 5 e 6
Bits torx tamper proof: T8; T10; T15; T20; T25; T27; T20 e T40
Bits torx: T6; T8; T9; T10; T15; T20; T25; T27; T30 e T40
Adaptador 1/4" hexagonal
Adaptador magnético



DR0119S

17.50€

Jogo de porta bits com 18 bits

Composição:

Bits 25mm
2 Phillips: #1; #2
2 Pozi: #1; #2
6 Hexagonal: 2; 2,5; 3; 4; 5 e 6mm
6 Torx: T10; T15; T20; T25; T30 e T40



DR04

9.80€

Punho de 1/4" com roquete reversível

Comprimento total: 157mm



DBT31B

19.90€

Jogo de porta pontas de punho

Composição/ medidas (mm):

Porta pontas de punho
Pontas phillips
Pontas fenda
Pontas pozi
Pontas hexagonais
Pontas torx



DBT53A
67.80€
Jogo de 54 bits de 1/4" (cores)

Composição/ medidas (mm):

- Porta bits 1/4" 60mm
- 5x Bits pozi (azul) de 25mm
- 4x Bits pozi (azul) de 75mm
- 5x Bits fenda (laranja) 25mm
- 2x Bits fenda (laranja) 75mm
- 11x Bits torx (amarelo) 25mm
- 11x Bits torx (amarelo) 75mm
- 5x Bits phillips (vermelho) de 25mm
- 4x Bits phillips (vermelho) de 75mm
- 4x Bits hexagonais (laranja claro) 25mm
- 3x Bits hexagonais (laranja claro) 75mm

RD0638S
58.60€
Jogo de roquete com bits 1/4" com 38 peças

Composição:

- R3702 Roquete 48 dentes de 1/4"
- S04H2 10 Chaves de caixa 1/4" de 5; 6; 7; 8; 9; 10; 11; 12; 13 e 14mm
- D125FC 3 Bits fenda 4; 5 e 6mm (25mm laranja)
- D125PC 4 Bits phillips PH1, PH2 x2 e PH3 (25mm vermelho)
- D125ZC 3 Bits pozi PZ1, PZ2 e PZ3 (25mm azul)
- D125HC 5 Bits hexagonal 3; 4; 5; 6 e 8mm (25mm laranja claro)
- D125TC 7 Bits torx T10, T15, T20, T25, T27, T30 e T40 (25mm amarelo)
- S44H2306 Porta bits hexagonal de 1/4"
- S24H250 Extensão de 1/4" de 50mm
- S24H2100 Extensão de 1/4" de 100mm
- S26H2150A Punho de 1/4"
- S15H240 Cardan de 1/4"

RD01032S
42.60€
Jogo roquete com bits 1/4" com 32 peças

Composição:

- Roquete 1/4" de 60 dentes
- Porta bits magnético
- Bits phillips
- Bits hexagonais
- Bits quadrados
- Bits pozi
- Bits torx
- Bits fenda
- Bits torx tamperproof

RD05H2
16.70€
Chave de mão para bits

Quadra: 1/4"

Chaves
S08H208S
7.90€
Jogo de porta pontas angular (90°)

Composição:

7 Pontas 1/4"

S29H2133S
15.70€
Jogo de porta bits 1/4" com 33 peças

Composição:

- Porta bits magnético
- Bits torx
- Bits torx tamperproof
- Bits perfil "Tri Wing"
- Bits perfil "Spanner"
- Bits hexagonais

S29TP23S
37.00€
Jogo de bits Torx Plus de 1/4" com 23 peças

Composição:

- 5 Bits torx plus tamperproof de 1/4": TS10H; TS15H; TS20H; TS25H e TS30H
- 5 Bits torx plus tamperproof de 10mm: TS40H; TS45H; TS50H; TS55H e TS60H
- 5 Bits torx plus de 1/4": IP10H; IP15H; IP20H; IP25H e IP30H
- 5 Bits torx plus de 10mm: IP40H; IP45H; IP50H; IP55H e IP60H
- 1 Adaptador 3/8" x 10mm:
- 1 Adaptador 1/4" x 1/4"
- 1 Porta bits 1/4" x 1/4" com 60mm comprimento

AI020092
90.70€
Extrator de parafusos danificados

Jogo de brocas/ extrator e guias para remoção de parafusos danificados

Gama: 5 a 16mm



AN040082

143.50€

Jogo de extrator de fêmeas danificadas com 9 peças 3/8"

Medidas: 10; 11; 12; 13; 14; 15; 16; 17 e 19



S14A4

Chave para retirar fêmeas danificadas 1/2"

Ref.	Medida (mm)	Comp. (mm)	Preço
S14A4117	17		14.30€
S14A4118	18,5		14.30€
S14A4120	20	25	14.40€
S14A4121	21,5		14.40€
S14A4123	23	30	15.50€
S14A4124	24,5	30	15.50€
S14A4126	26	30	15.50€
S14A4127	27,5	33	15.90€

S14A4108S

122.00€

Jogo de 8 chaves para retirar fêmeas danificadas 1/2"

Composição/ medidas (mm):

Chaves: 17; 18,5; 20; 21,5; 23; 24,5; 26 e 27,5





D125H

Pontas/ bits de 1/4" hexagonais

Ref.	Medida (mm)	Compr. (mm)	Preço
D125H015A	1,5	25	0.45€
D125H020A	2	25	0.45€
D125H025A	2,5	25	0.45€
D125H030A	3	25	0.45€
D125H040A	4	25	0.45€
D125H050A	5	25	0.45€
D125H060A	6	25	0.45€
D125H070A	7	25	0.65€



D125T

Pontas/ bits de 1/4" torx

Ref.	Medida (mm)	Compr. (mm)	Preço
D125T06A	T6	25	0.45€
D125T08A	T8	25	0.45€
D125T10A	T10	25	0.45€
D125T15A	T15	25	0.45€
D125T20A	T20	25	0.45€
D125T25A	T25	25	0.45€
D125T27A	T27	25	0.45€
D125T30A	T30	25	0.45€
D125T40A	T40	25	0.45€



D125F

Pontas/ bits de 1/4" fenda

Ref.	Medida (mm)	Compr. (mm)	Preço
D125F4506A	0,6x4,5	25	0.45€
D125F6512A	1,2x6,5	25	0.45€
D125F8016A	1,6x8	25	0.75€



D125P

Pontas/ bits de 1/4" phillips

Ref.	Medida (mm)	Compr. (mm)	Preço
D125P1F	PH1	25	0.45€
D125P2F	PH2	25	0.45€
D125P3F	PH3	25	0.45€



D125Z

Pontas/ bits de 1/4" pozi

Ref.	Medida (mm)	Compr. (mm)	Preço
D125Z1A	PZ1	25	0.45€
D125Z2A	PZ2	25	0.45€
D125Z3A	PZ3	25	0.45€



as pontas bits são vendidas em embalagens de 10 unidades os Precios indicados são por unidade

D130H

Pontas/ bits de 10mm hexagonais

Ref.	Medida (mm)	Compr. (mm)	Preço
D130H40	4	30	1.10€
D130H50	5	30	1.10€
D130H60	6	30	1.10€
D130H70	7	30	1.10€
D130H80	8	30	1.20€
D130H100	10	30	1.20€
D130H120	12	30	1.30€



D130T

Pontas/ bits de 10mm torx

Ref.	Medida (mm)	Compr. (mm)	Preço
D130T20	T20	30	1.10€
D130T25	T25	30	1.10€
D130T30	T30	30	1.10€
D130T40	T40	30	1.10€
D130T45	T45	30	1.10€
D130T50	T50	30	1.10€
D130T55	T55	30	1.10€



D150F

Pontas/ bits de 1/4" fenda

Ref.	Medida (mm)	Compr. (mm)	Preço
D150F5510A	1x5,5	50	0.65€
D150F6512A	1,2x6,5	50	0.65€
D150F8012A	1,2x8	50	0.85€



D150P

Pontas/ bits de 1/4" phillips

Ref.	Medida (mm)	Compr. (mm)	Preço
D150P1A	PH1	50	0.65€
D150P2A	PH2	50	0.65€
D150P3A	PH3	50	0.65€



D150Z

Pontas/ bits de 1/4" pozi

Ref.	Medida (mm)	Compr. (mm)	Preço
D150Z1A	PZ1	50	0.65€
D150Z2A	PZ2	50	0.65€
D150Z3A	PZ3	50	0.65€



D150H



Pontas/ bits de 1/4" hexagonais

Ref.	Medida (mm)	Compr. (mm)	Preço
D150H030A	3	50	0.65€
D150H040A	4	50	0.65€
D150H050A	5	50	0.65€
D150H060B	6	50	0.65€
D150H070B	7	50	0.75€
D150H080B	8	50	0.85€

D150T



Pontas/ bits de 1/4" torx

Ref.	Medida (mm)	Compr. (mm)	Preço
D150T20A	T20	50	0.65€
D150T25A	T25	50	0.65€
D150T27A	T27	50	0.65€
D150T30A	T30	50	0.65€
D150T40A	T40	50	0.65€

D100MN



Ponta hexagonal magnética de 1/4" para fêmeas

Ref.	Medida (mm)	Compr. (mm)	Preço
D100MN08M	8	100	3.90€
D100MN10M	10	100	4.60€
D100MN12M	12	100	4.90€
D100MN13M	13	100	4.90€
D100MN14M	14	100	5.10€

D100N



Ponta hexagonal de 1/4" para fêmeas

Ref.	Medida (mm)	Compr. (mm)	Preço
D100N13M	13	100	3.60€

D10M3



Pontas/ bits de 10mm estriado XZN

Ref.	Medida (mm)	Compr. (mm)	Preço
D10M30M05A	M5	30	1.10€
D10M30M06A	M6	30	1.10€
D10M30M08A	M8	30	1.10€
D10M30M10A	M10	30	1.10€
D10M30M12A	M12	30	1.30€
D10M30M14A	M14	30	1.50€

D10M7



Pontas/ bits de 10mm estriado XZN

Ref.	Medida (mm)	Compr. (mm)	Preço
D10M75M05A	M5	75	1.70€
D10M75M06A	M6	75	1.80€
D10M75M08A	M8	75	1.80€
D10M75M10A	M10	75	1.80€
D10M75M12A	M12	75	2.10€
D10M75M14A	M14	75	2.40€

D175H



Pontas/ bits de 10mm hexagonais

Ref.	Medida (mm)	Compr. (mm)	Preço
D175H40	4	75	1.80€
D175H50	5	75	1.80€
D175H60	6	75	1.80€
D175H70	7	75	1.80€
D175H80	8	75	1.80€
D175H100	10	75	1.80€
D175H120	12	75	2.30€

D175T



Pontas/ bits de 10mm torx longo

Ref.	Medida (mm)	Compr. (mm)	Preço
D175T20	T20	75	1.90€
D175T25	T25	75	1.90€
D175T30	T30	75	1.90€
D175T40	T40	75	1.90€
D175T45	T45	75	1.90€
D175T50	T50	75	1.90€
D175T55	T55	75	1.90€

D125TT



Pontas/ bits de 1/4" torx tamper proof

Ref.	Medida (mm)	Compr. (mm)	Preço
D125TT08A	T8	25	0.55€
D125TT10A	T10	25	0.55€
D125TT15A	T15	25	0.55€
D125TT20A	T20	25	0.55€
D125TT25A	T25	25	0.55€
D125TT27A	T27	25	0.55€
D125TT30A	T30	25	0.55€
D125TT35A	T35	25	0.55€
D125TT40A	T40	25	0.55€

D150MH

Porta pontas/ bits magnético para bits de 1/4"



Ref.	Medida (mm)	Compr. (mm)	Preço
D150MH1AD	10	50	2.50€

D150MH

Porta bits magnético p/bit 1/4" c/bloqueio



Ref.	Medida (mm)	Compr. (mm)	Preço
D150MH1QD	10,5	50	6.00€
D160MH1QD	10,5	60	6.00€

D165MN

Ponta hexagonal magnética de 1/4" para fêmeas



Ref.	Medida (mm)	Compr. (mm)	Preço
D165MN06M	6	65	2.60€
D165MN07M	7	65	2.60€
D165MN08M	8	65	2.70€
D165MN10M	10	65	3.50€
D165MN12M	12	65	4.30€
D165MN13M	13	65	4.30€

S29H2180S

44.30€

Conjunto de 180 pontas

Composição:

- phillips
- pozi
- hexagonais
- torx



H01MH118S

51.90€

Jogo de 18 chaves hexagonais curtas

Composição/ medidas (mm):

- Chaves: 1,5; 2; 2,5; 3; 3,5;
- 4; 4,5; 5; 5,5; 6; 7; 8; 9; 10;
- 12; 14; 17 e 19



H01SA109S

12.80€

Jogo de 9 chaves hexagonais curtas

Sistema especial antideslizante

Composição/ medidas (mm):

- Chaves: 1,5; 2; 2,5; 3;
- 4; 5; 6; 8 e 10



Chaves

H01B

Chave hexagonal curta



Ref.	Medida (mm)	Preço
H01B1015	1,5	0.15€
H01B1020	2	0.15€
H01B1025	2,5	0.25€
H01B1030	3	0.35€
H01B1035	3,5	0.45€
H01B1040	4	0.65€
H01B1045	4,5	0.85€
H01B1050	5	0.85€
H01B1055	5,5	0.85€
H01B1060	6	0.95€
H01B1070	7	1.20€
H01B1080	8	1.40€
H01B1090	9	2.00€
H01B1100	10	2.30€
H01B1120	12	4.30€
H01B1140	14	6.00€
H01B1160	16	8.10€
H01B1170	17	8.90€
H01B1180	18	11.30€
H01B1190	19	13.00€
H01B1220	22	19.30€

H01SM109S

13.60€

Jogo de 9 chaves hexagonais curtas

Composição/ medidas (mm):

- Chaves: 1,5; 2; 2,5; 3;
- 4; 5; 6; 8 e 10



H02MH217S

74.20€

Jogo de 17 chaves hexagonais longas SAE

Composição/ medidas:

- Chaves: 1/16"; 5/64"; 3/32";
- 7/64"; 1/8"; 9/64"; 5/32"; 3/16";
- 1/4"; 5/16"; 3/8"; 7/16";
- 1/2"; 9/16"; 5/8" e 3/4"



H02SM109S

17.00€

Jogo de 9 chaves hexagonais longas

Composição/ medidas (mm):

- Chaves: 1,5; 2; 2,5; 3; 4;
- 5; 6; 8 e 10



H02SM209S

17.00€

Jogo de 9 chaves hexagonais longas SAE

Composição/ medidas:

- Chaves: 1/16"; 5/64";
- 3/32"; 1/8"; 5/32";
- 3/16"; 1/4"; 5/16" e 3/8"



H01SA



Chaves hexagonais curtas antideslizante

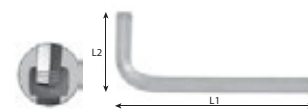

Ref.	Medida (mm)	L1 (mm)	L2 (mm)	Preço
H01SA115	1,5	46,5	15,5	0.55€
H01SA120	2	52	18	0.55€
H01SA125	2,5	58,5	20,5	0.65€
H01SA130	3	66	23	0.85€
H01SA140	4	74	29	1.20€
H01SA150	5	85	33	1.40€
H01SA160	6	96	38	1.90€
H01SA180	8	108	44	2.00€
H01SA1100	10	122	50	3.30€

H06SA



Chaves hexagonais extra longas com ponta esférica antideslizante



Ref.	Medida	L1 (mm)	L2 (mm)	Preço
H06SA115	1,5	91,5	15,5	0.75€
H06SA120	2	102	18	0.75€
H06SA125	2,5	114,5	20,5	0.75€
H06SA130	3	129	23	1.00€
H06SA140	4	144	29	1.40€
H06SA150	5	165	33	1.70€
H06SA160	6	186	38	2.50€
H06SA180	8	208	44	3.10€
H06SA1100	10	234	50	4.40€

H12S



Chaves torx extra longa



Ref.	Medida	L1 (mm)	L2 (mm)	Preço
H12S09085	T9	85	5	1.60€
H12S10090	T10	90	5,5	1.60€
H12S15100	T15	100	8	1.60€
H12S20115	T20	115	12,5	1.80€
H12S25130	T25	130	18	1.80€
H12S27145	T27	145	24,5	2.10€
H12S30165	T30	165	40	2.50€
H12S40185	T40	185	62	3.00€
H12S45205	T45	205	98	3.50€
H12S50230	T50	230	128	4.80€

H20MT



Chaves torx dupla de punho



Ref.	Medida	L1 (mm)	L2 (mm)	Preço
H20MT10	T10	110	15	4.00€
H20MT15	T15	120	15	4.10€
H20MT20	T20	125	16	4.80€
H20MT25	T25	135	16	5.10€
H20MT27	T27	145	16	5.20€
H20MT30	T30	155	16	5.80€
H20MT40	T40	165	16	6.20€
H20MT45	T45	185	16	7.20€
H20MT50	T50	205	20	8.60€

H03MH118S

82.70€
Jogo de 18 chaves hexagonais extra longas

Composição/ medidas (mm):

 Chaves: 1,5; 2; 2,5; 3; 3,5; 4;
4,5; 5; 5,5; 6; 7; 8; 9;
10; 12; 14; 17 e 19

H03SM109S

18.80€
Jogo de 9 chaves hexagonais extra longas

Composição/ medidas (mm):

 Chaves: 1,5; 2; 2,5;
3; 4; 5; 6; 8 e 10

H06SA109S

19.70€
Jogo de 9 chaves hexagonais macho extra longas com ponta esférica antideslizante

H06SM209S

21.30€
Jogo de 9 chaves hexagonais com ponta esférica SAE

Composição/ medidas (mm):

 Chaves: 1/16"; 5/64";
3/32"; 1/8"; 5/32"; 3/16";
1/4"; 5/16" e 3/8"

H03SS109S

21.80€
Jogo de 9 chaves macho hexagonais de baixo perfil

Composição/ medidas (mm):

 Chaves: 1,5; 2; 2,5;
3; 4; 5; 6; 8 e 10

H05SS109S

21.00€
Jogo de 9 chaves macho hexagonais com ponta esférica de baixo perfil

Composição/ medidas (mm):

 Chaves: 1,5; 2; 2,5; 3;
4; 5; 6; 8 e 10 mm

H05SA109S

18.30€
Jogo de 9 chaves hexagonais longas com ponta esférica antideslizante

Composição/ medidas (mm):

 Chaves: 1,5; 2; 2,5; 3;
4; 5; 6; 8 e 10

H06ST108S

23.90€
Conjunto de 8 chaves hexagonais longas com ponta esférica

Composição/ medidas (mm):

 Chaves: 2; 2,5; 3;
4; 5; 6; 8 e 10 mm

H06SM

Chave hexagonal longa de ponta esférica SAE

Ref.	Medida	Preço
H06SM170	7	2.80€
H06SM225	3/32"	0.95€
H06SM230	1/8"	1.10€
H06SM240	5/32"	1.50€
H06SM250	3/16"	2.00€
H06SM255	7/32"	2.10€
H06SM260	1/4"	2.20€
H06SM280	5/16"	3.50€
H06SM2100	3/8"	4.80€

H06W106S

78.80€
Jogo de 6 chaves articuladas hexagonais de ponta redonda

Composição/ medidas (mm):

Chaves: 3; 4; 5; 6; 8 e 10

H07M09S

16.00€
Jogo de 9 chaves torx

Composição/ medidas (mm):

 Chaves: T10; T15; T20; T25;
T27; T30; T40; T45 e T50

H07MT

Chave torx em L

Ref.	Medida	Preço
H07MT10	T10	1.10€
H07MT15	T15	1.20€
H07MT20	T20	1.30€
H07MT25	T25	1.30€
H07MT27	T27	1.60€
H07MT30	T30	1.60€
H07MT40	T40	1.90€
H07MT45	T45	2.30€
H07MT50	T50	2.90€

Chaves

H0816S



29.90€

Jogo de 16 chaves macho com ponta torx

Composição/ medidas (mm):

Chaves: T6; T7; T8; T9; T10; T15;
T20; T25; T27; T30; T40; T45;
T50; T55; T60 e T70



H08MTP09S



17.40€

Jogo de 9 chaves torx tamperproof

Composição/ medidas (mm):

Chaves: T10; T15; T20; T25;
T27; T30; T40; T45 e T50



H08S110S



28.00€

Jogo de 10 chaves torx longas tamperproof

Composição/ medidas (mm):

Chaves: T9; T10; T15; T20;
T25; T27; T30; T40; T45 e T50



H08ST



Chaves torx longas tamperproof

Ref.	Medida	Compr. (mm)	Preço
H08ST09085	T9	80	1.80€
H08ST10090	T10	90	1.80€
H08ST15100	T15	100	1.90€
H08ST20115	T20	112	2.00€
H08ST25130	T25	126	2.00€
H08ST27145	T27	142	2.10€
H08ST30165	T30	160	2.60€
H08ST40185	T40	180	3.00€
H08ST45205	T45	200	3.70€
H08ST50230	T50	224	4.80€

H10MB08S



43.70€

Jogo de 8 chaves hexagonais duplas de punho

Composição/ medidas (mm):

Chaves: 2x100; 2,5x100;
3x100; 4x100; 5x150; 6x150;
8x200 e 10x200



JONNESWAY



H10MB

Chave hexagonal dupla de punho com ponta esférica

Ref.	Medida	Preço
H10MB2100	2x100	3.60€
H10MB25100	2,5x100	3.60€
H10MB3100	3x100	3.70€
H10MB4100	4x100	3.80€
H10MB5150	5x150	4.20€
H10MB6150	6x150	4.50€
H10MB8200	8x200	6.80€
H10MB10200	10x200	9.00€

H10MT09S

50.60€

Jogo de 9 chaves duplas torx tamperproof com punho

Composição/ medidas (mm):

Chaves: T10x100; T15x100;
T20x100; T25x100; T27x150;
T30x150; T40x150; T45x200
e T50x200



H10MT

Chave dupla de punho torx tamperproof

Ref.	Medida	Preço
H10MT10100	T10x100	3.80€
H10MT15100	T15x100	3.90€
H10MT20100	T20x100	3.90€
H10MT25100	T25x100	3.90€
H10MT27150	T27x150	4.40€
H10MT30150	T30x150	4.40€
H10MT40150	T40x150	5.40€
H10MT45200	T45x200	7.80€
H10MT50200	T50x200	8.10€

H12S110S



25.90€

Jogo de 10 chaves torx longas

Composição/ medidas (mm):

Chaves: T9; T10;
T15; T20; T25; T27;
T30; T40; T45 e T50



H15M105S

21.10€

Jogo de 5 chaves estriadas em "L"

Composição/ medidas (mm):

Chaves: M5; M6; M8; M10 e M12



H20MB1037S

74.60€

Jogo de 9 chaves hexagonais de ponta esférica com punho e 28 bits

Composição/ medidas (mm):

H20MB

Chaves: H1,5X100; H2X100; H2,5X110; H3X120;

H4X125; H5X155; H6X165; H8X185 e H10X210

Bits phillips: PH1; PH2 e PH3

Bits pozi: PZ1; PZ2 e PZ3

Bits torx: T10; T15; T20; T25; T27; T30; T35 e T40

Bits fenda: 3; 4; 5; 6 e 7

Bits estriados: M4; M5 e M6

Bits quadrados: 1; 2 e 3

Bits spanner: 4 e 6



H20MT09S

72.50€

Jogo de 9 chaves torx duplas de punho

Composição/ medidas (mm):

Chaves: T10x110; T15x120; T20x125; T25x135; T27x145; T30x155; T40x165; T45x185 e T50x205



H22S109S

25.60€

Jogo de 9 chaves hexagonais extra longas estriadas

Especial para remover parafusos danificados

Composição/ medidas (mm):

Chaves: 1,5; 2; 2,5; 3; 4; 5; 6; 8 e 10



Martelos

M03025

33.90€

Marreta metálica

Peso: 1 330g



M040

Martelo com batente redondo e pena esférica

Ref.	Peso (g)	Compr. (mm)	Preço
M04008	395	278	14.90€
M04012	527	283	15.60€
M04016	780	327	17.90€
M04024	1 063	383	23.70€
M04032	1 208	385	26.00€



M010

Martelo de orelhas em aço

Ref.	Peso (g)	Compr. (mm)	Preço
M01016	777	320	34.60€
M01020	875	350	37.50€



M05020

21.90€

Martelo de orelhas

Peso: 830g

Comprimento: 330mm



M060

Marreta

Ref.	Peso (g)	Compr. (mm)	Preço
M06030	1 550	263	24.40€
M06040	2 250	276	28.60€



M07016

22.70€

Martelo de batentes plásticos

Peso: 840g

Comprimento: 314mm



M07016-ACE

3.60€

Batente amarelo de substituição M07016



M07016-TPR

2.10€

Batente preto de substituição M07016



JONNESWAY

M29

Martelo de batentes plásticos intermutáveis

Ref.	Diâmetro (mm)	Compr. (mm)	Preço
M2932	32	290	28.40€



M29

Batentes para martelo M2927

Ref.	Cor	Preço
M2927-T2	amarelo	4.60€



M29

Batentes para martelo M2932

Ref.	Cor	Preço
M2932-T1	branco	3.70€
M2932-T2	amarelo	4.70€



M29

Batentes para martelo M2940

Ref.	Cor	Preço
M2940-T2	amarelo	7.20€



M29

Batentes para martelo M2950

Ref.	Cor	Preço
M2950-T1	branco	7.00€
M2950-T2	amarelo	10.50€



M09

Martelo de mecânico tipo "alemão"

Ref.	Peso (g)	Compr. (mm)	Preço
M09100	100	260	9.70€
M09200	200	280	10.90€
M09300	300	300	13.20€
M09500	500	320	17.80€
M09800	800	350	20.90€
M091000	1 000	360	27.20€



M110

Martelo anti recuo revestido a borracha

Ref.	Peso (g)	Compr. (mm)	Preço
M11035	400	260	19.10€
M11045	520	286	22.10€
M11065	1500	370	39.30€



M601
Punção de bico

Ref.	D (mm)	D1 (mm)	L (mm)	Preço
M60103	3	9,5	120	2.10€
M60104	4	9,5	120	2.80€
M60105	5	12	120	3.60€

M611
Talhadeira

Ref.	D (mm)	D1 (mm)	L (mm)	Preço
M61110	10	9,5	150	3.20€
M61112	12	9,5	130	3.20€
M61113	13	9,5	150	3.40€
M61116	16	12,7	180	4.50€
M61119	19	15,8	180	6.30€
M61122	22	15,8	200	6.80€
M61125	25	19	200	9.70€

M621
Punção

Ref.	D (mm)	D1 (mm)	L (mm)	Preço
M62102	2	9,5	120	2.50€
M62103	3	9,5	120	2.50€
M62104	4	9,5	120	2.60€
M62105	5	9,5	120	2.60€
M62106	6	9,5	120	2.60€
M62108	8	9,5	120	2.60€

M631
Saca troços

Ref.	D (mm)	D1 (mm)	L (mm)	Preço
M63102	2	8	115	2.70€
M63103	3	8	125	2.90€
M63104	4	9,5	150	3.30€
M63105	5	9,5	165	3.60€
M63106	6	12,7	180	4.30€
M63108	8	12,7	180	4.40€

M641
Buril

Ref.	D (mm)	D1 (mm)	L (mm)	Preço
M64105	5	9,5	130	4.10€

M63106S

21.10€

Jogo de 6 saca troços

Composição/ medidas (mm):
 2x8x115; 3x8x125;
 4x9,5x150; 5x9,5x165;
 6x12,7x180 e 8x12,7x180



M63M106S

24.10€

Jogo de 6 saca troços cromados

Composição/ medidas (mm):
 2x8x115; 3x8x125; 4x9,5x150;
 5x9,5x165; 6x12,7x180 e 8x12,7x180

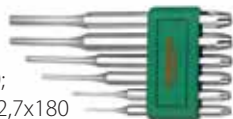

M64105S

16.10€

Jogo de 5 punções e escopros

Composição/ medidas (mm):
 Punção: 2x8x115; 3x8x125;
 4x9,5x150; 5x9,5x165; 6x12,7x180
 Escopro: 8x12,7x180



M64M105S

18.00€

Jogo de 5 punções e escopros cromados

Composição/ medidas (mm):
 Punção: 3x 9,5x120
 Punção bico: 2x9,5x120
 Talhadeira: 12x9,5x130
 Saca troços: 4x9,5x150
 Escopro: 5x9,5x130



M61H1

Escopro com punho de proteção

Ref.	Medida (mm)	Compr. (mm)	Preço
M61H116	16	170	6.90€
M61H119	19	190	8.20€
M61H124	24	220	12.50€



M62H1

Punção com punho de proteção

Ref.	Medida (mm)	Compr. (mm)	Preço
M62H102	2	185	5.80€
M62H103	3	185	5.80€
M62H104	4	185	5.80€
M62H106	6	185	5.80€



M63H1

Saca troços com punho de proteção

Ref.	Medida (mm)	Compr. (mm)	Preço
M63H103	3	150	4.70€
M63H105	5	200	6.10€
M63H106	6	210	7.70€
M63H108	8	220	8.40€



M64A155

18.60€

Punção manual com regulação de força



AI030045

153.40€

Jogo de 4 cinzéis com proteção



MF05

Limas

Ref.	Tipo	Medida (mm)	Preço
MF05A	chata	200	10.40€
MF05B	redonda	200	8.40€
MF05C	meia cana	200	10.40€
MF05D	quadrada	200	9.70€
MF05E	triangular	200	9.50€

MF05S

59.70€

Jogo de 5 limas de 200mm

Composição:

MF05A	Lima chata
MF05B	Lima redonda
MF05C	Lima meia cana
MF05D	Lima quadrada
MF05E	Lima triangular

MF06S

29.00€

Jogo de 6 mini limas de 100mm

Composição:

- Mini lima redonda
- Mini lima triangular
- Mini lima quadrada
- Mini lima meia cana
- Mini lima plana
- Mini lima plana em bico

MHS100AG

25.50€

Serra

MHS300

21.20€

Serra multi ângulos

P9601

14.60€

Navalha corta cabos

Corte, desbaste e medida
MK2040

11.80€

 X-ato com lâmina retrátil
Com 2 lâminas de substituição

MK2040-B

1.80€

Lâmina para x-ato MK2040 - 5 unidades

MK2080

12.90€

X-ato

 Botão de segurança lâmina
Inclui 4 lâminas 18x100mm

MKS27

25.20€

Jogo de x-ato

Composição:

- X-ato
- Raspador
- Acessórios

MKS27

Lâmina raspador - 100 unidades

Ref.	Tipo	Medida (mm)	Preço
MKS27-12	A	12	23.60€
MKS27-16	B	16	27.30€
MKS27-16A	C	(53°) 16	27.80€
MKS27-20	D	20	24.10€
MKS27-SK2	Lâmina x-ato		24.10€

MT09

Fita métrica

Corpo em plástico ABS resistente ao choque

Ref.	Compr. (m)	Preço
MT0901	3	4.50€
MT0902	5	7.30€



Corte, desbaste e medida

MTC

Paquímetro digital

Ref.	Compr. (mm)	Preço
MTC150	150	78.70€
MTC200	200	125.50€



MTC1

Paquímetro leitura vigesimal

Ref.	Compr. (mm)	Preço
MTC1150	150	53.40€
MTC1200	200	88.60€
MTC1300	300	127.80€



MTC153

Esquadro metálico

Dimensões: 300x40x1mm

20.30€



MTC155

Caneta de gravação e marcação de metal, ponta tungstênio

13.90€



MTC156

Régua metálica

Dimensões: 334x23,7x1mm

3.30€



JONNESWAY

MTC3

Compasso de precisão pontas direitas

Ref.	Compr. (mm)	Preço
MTC306	150	21.20€
MTC308	200	23.80€



MTC408

Compasso de precisão pontas curvas para exteriores

Comprimento: 200mm

22.60€



MTC508

Compasso de precisão pontas curvas para interiores

Comprimento: 200mm

22.60€



MTM1

Micrómetro exteriores

Ref.	Medida (mm)	Preço
MTM1025	0-25	44.10€
MTM1050	25-50	49.30€
MTM1075	50-75	54.00€
MTM1100	75-100	66.60€



DV13P
Chave phillips isolada (1000 Volts)

Ref.	Medida	L1 (mm)	L2 (mm)	L (mm)	Preço
DV13P060	PH0	60	98	158	4.40€
DV13P180	PH1	80	104	184	5.40€
DV13P2100	PH2	100	110	210	6.30€
DV13P3150	PH3	150	120	270	7.70€

DV13S
Chave fenda isolada (1000 Volts)

Ref.	Medida (mm)	L1 (mm)	L2 (mm)	L (mm)	Preço
DV13S275	2,5	75	98	173	4.70€
DV13S3100	3x100	100	80	180	5.10€
DV13S4100	4	100	98	198	5.50€
DV13S5125	5,5	125	104	229	5.50€
DV13S6150	6,5	150	110	260	7.00€
DV13S8175	8x175	175	120	295	8.70€

DV13Z
Chave pozi isolada (1000 Volts)

Ref.	Medida (mm)	L1 (mm)	L2 (mm)	L (mm)	Preço
DV13Z060	PZ0x60	60	98	158	4.60€
DV13Z180	PZ1x80	80	104	184	5.70€
DV13Z2100	PZ2x100	100	110	210	6.20€
DV13Z3150	PZ3x150	150	120	270	8.00€

S43V
Cabo "T" com isolamento a 1 000V

Ref.	Quadra	Compr. (mm)	Peso (g)	Preço
S43V38	3/8"	200	240	42.90€
S43V48	1/2"	250	330	46.50€

RV03
Roquete com isolamento a 1 000V

Ref.	Quadra	Compr. (mm)	Peso (g)	Preço
RV032	1/4"	150	140	49.50€
RV033	3/8"	200	300	59.80€
RV034	1/2"	250	570	69.10€

Novo TV01050N
Chave dinamometrica isolada a 1 000V

Precisão +/- 4%	Quadra 3/8"	Compr. 390mm	Torque 5-50Nm
-----------------	-------------	--------------	---------------

497.90€



DV13PP07S

56.50€

Jogo de chaves isoladas fenda/ phillips (1000 Volts)

Composição/ medidas (mm):

Chaves fenda: 4x100; 5,5x125 e 6,5x150
Chaves phillips: PH0x60; PH1x80 e PH2x100
Busca-polos



DV41M

Chaves de caixa isoladas com punho (1000 Volts)

Ref.	Medida	Compr. (mm)	Preço
DV41M5	M5	125	8.50€
DV41M6	M6	125	8.50€
DV41M7	M7	125	8.50€
DV41M8	M8	125	8.60€
DV41M10	M10	125	8.70€
DV41M13	M13	125	9.90€



DV4118SV

199.80€

Tabuleiro EVA com ferramentas isoladas (1000 volts)

Composição:

Ref.	Chave	Medida (mm)
DV13S275	fenda	2,5x75
DV13S3100	fenda	3x100
DV13S4100	fenda	4x100
DV13S5125	fenda	5,5x125
DV13P060	phillips	PH0x60
DV13P180	phillips	PH1x80
DV13P2100	phillips	PH2x100
DV13P3150	phillips	PH3x150
DV41M	caixa punho	M4x125; M5x125; M5,5x125; M6x125; M7x125; M8x125; M9x125; M10x125; M11x125 e M12x125

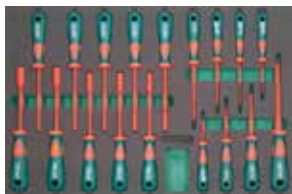

DV41M06S

68.60€

Jogo de 6 chaves de caixa isoladas com punho (1000 Volts)

Composição/ medidas:

Chaves caixa: M5; M6; M7; M8; M10 e M13



DV15109S

42.90€

Bolsa de 7 chaves isoladas (fenda/phillips)



MKV7

13.80€

X-ato isolado 1000V

Comprimento: 180mm

Lâmina: 50mm



MKV7-K

19.80€

Lâmina para x-ato isolado 1000 volts - 4 unidades



MKV8

21.70€

Navalha isolada 1000V

Comprimento: 180 mm

Lâmina: 50mm



PV0118

29.20€

Alicate universal

Cumpra a norma IEC 60900

Compr. (mm)	○	◐	◑	●
200	4.0	3.0	2.0	1.6



PV08

Alicate universal isolado (1000 volts)

Cumpra a norma IEC 60900

Ref.	Compr. (mm)	○	◐	◑	●	Preço
PV0816	160	4.0	3.0	2.0	1.6	22.20€
PV0817	180	4.0	3.0	2.0	1.6	24.40€



PV0518 31.70€

Alicate corta cabos (trabalho intensivo)

Cumpre a norma IEC 60900

 Comprimento: 200mm
 Capacidade de corte: Ø13/60mm

PV0918 28.20€

Alicate de corte

Cumpre a norma IEC 60900

Compr. (mm)				
200	4.0	3.0	2.0	1.6

PV1016 22.90€

Alicate de corte diagonal

Cumpre a norma IEC 60900

Compr. (mm)				
160	4.0	3.0	2.0	1.6

PV1116 23.00€

Alicate de pontas redondas isolado (1000 volts)

Cumpre a norma IEC 60900

Comprimento: 160mm

PV1118 24.40€

Alicate de pontas

Cumpre a norma IEC 60900

Compr. (mm)				
200	4.0	3.0	2.0	1.6

PV1218 25.70€

Alicate de pontas redondas

Cumpre a norma IEC 60900

Compr. (mm)				
200	4.0	3.0	2.0	1.6

PV1416 21.80€

Alicate de pontas chatas

Cumpre a norma IEC 60900

Comprimento: 160mm

PV1516 22.60€

Alicate de descarnar fios (trabalho intensivo)

Cumpre a norma IEC 60900

Comprimento: 160mm

PV28110 30.60€

Alicate ajustável

Cumpre a norma IEC 60900

Comprimento: 275mm

PV4006 28.70€

Alicate de pontas redondas

Cumpre a norma IEC 60900

Comprimento: 200mm

PSV218SP 119.20€

Jogo de ferramentas isoladas 1 000V

Composição/ medidas em mm:

- 2 Chaves phillips isoladas: PH1x80; PH2x100
- 2 Chaves fenda isoladas: 5x125; 6x150
- 1 Alicate de corte diagonal
- 1 Alicate de universal
- 1 Alicate de pontas
- 1 Busca polos

PSV110SC 187.80€

Jogo de 10 ferramentas isoladas 1 000V

Composição:

- 4 Alicates
- 4 Chaves de fenda/ phillips
- 1 Navalha
- 1 Busca-polos

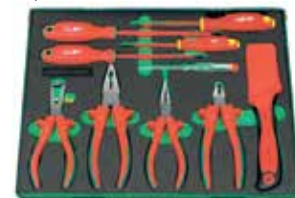
S03V21
Chaves de caixa 1/4" com isolamento a 1 000V

Ref.	Medida (mm)	Compr. (mm)	Preço
S03V2106	6	41	6.10€
S03V2108	8	41	6.10€
S03V2110	10	41	6.10€
S03V2114	14	41	6.70€



S03V31



Chaves de caixa 3/8" com isolamento a 1 000V

Ref.	Medida (mm)	Compr. (mm)	Preço
S03V3108	8	44,5	7.50€
S03V3110	10	44,5	7.50€
S03V3112	12	44,5	7.70€
S03V3113	13	44,5	8.20€
S03V3114	14	44,5	8.20€
S03V3117	17	44,5	8.80€
S03V3119	19	46	9.40€
S03V3122	22	46	10.80€

S03V41



Chaves de caixa 1/2" com isolamento a 1 000V

Ref.	Medida (mm)	Compr. (mm)	Preço
S03V4110	10	55	9.10€
S03V4111	11	55	9.50€
S03V4112	12	55	9.70€
S03V4113	13	55	9.70€
S03V4114	14	55	10.30€
S03V4117	17	55	10.40€
S03V4119	19	57	10.50€
S03V4122	22	57	12.30€
S03V4124	24	57	12.80€
S03V4127	27	59	15.60€
S03V4132	32	59	17.80€

S03V3116SC

287.70€

Jogo de 16 peças 3/8" com roquete isolado a 1 000V

B

Composição/ medidas em mm:

RV033	Roquete isolado 200
S43V38	Cabo "T" 200
S25V36	Extensão 150
S25V310	Extensão 250
S03V3	Chaves de caixa: 8; 10; 12; 13; 14; 17; 19 e 22
S09V3	Bits: 4; 5; 6 e 8



S03V4120SC

396.00€

Jogo de 20 peças 1/2" com roquete isolado a 1 000V

Composição/ medidas em mm:

RV034	Roquete isolado 250
S43V48	Cabo "T" 200
S25V45	Extensão 125
S25V410	Extensão 250
S03V4	Chaves de caixa: 10; 11; 12; 13; 14; 17; 19; 22; 24; 27 e 32
S09V4	Bits: 4; 5; 6; 8 e 10



S03V3136SV

520.00€

Tabuleiro EVA com ferramentas de 1/4" e 3/8" isoladas a 1 000V

Composição/ medidas em mm:

RV032	Roquete de 1/4"
RV033	Roquete de 3/8"
S43V28	Cabo "T" de 1/4" de 125
S43V38	Cabo "T" de 3/8" de 200
S25V24	Extensão de 1/4" de 100
S25V3	Extensão de 3/8" de 150 e 250
S03V21	10 Chaves de caixa: 5 a 14
S03V31	11 Chaves de caixa: 8 a 22
S09V2H	4 Bits de caixa de 1/4" de 60
S09V3H	4 Bits de caixa de 3/8" de 60

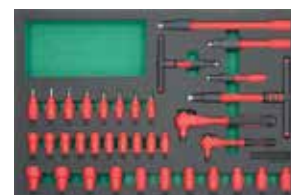

S03V4124SV

478.70€

Tabuleiro EVA com ferramentas 1/2" isoladas a 1 000V

Composição/ medidas em mm:

RV034	Roquete de 1/2"
S43V48	Cabo "T" de 1/2" de 200
S25V4	Extensão de 125 e 250
S03V41	13 Chaves de caixa: 10 a 32
S09V41H	5 Bits de caixa de 200
WV27AS8	Chave inglesa de 150
MKV7	X-acto



S09V3H



Chaves de caixa hexagonal 3/8" com isolamento a 1 000V

Ref.	Medida (mm)	Compr. (mm)	Preço
S09V3H4	4	60	8.80€
S09V3H5	5	60	8.80€
S09V3H6	6	60	9.10€
S09V3H8	8	60	10.20€

S09V41H



Chaves de caixa 3/8" com isolamento a 1 000V

Ref.	Medida (mm)	Compr. (mm)	Preço
S09V41H4	4	120	12.40€
S09V41H5	5	120	12.40€
S09V41H6	6	120	12.40€
S09V41H8	8	120	12.40€
S09V41H10	10	120	13.80€

S25V3

Extensão 3/8" com isolamento a 1 000V



Ref.	Compr. (mm)	Peso (g)	Preço
S25V36	150	150	29.90€
S25V310	250	250	35.90€

S25V4

Extensão 1/2" com isolamento a 1 000V



Ref.	Compr. (mm)	Peso (g)	Preço
S25V45	150	210	33.50€
S25V410	250	410	37.00€

W23V1

Chaves luneta com isolamento a 1 000V



Ref.	Medida (mm)	Compr. (mm)	Preço
W23V108	8	164	22.60€
W23V110	10	174	23.30€
W23V111	11	184	24.30€
W23V112	12	184	24.30€
W23V113	13	205	26.80€
W23V114	14	205	26.80€
W23V116	16	221	29.80€
W23V117	17	221	30.40€
W23V118	18	237	34.50€
W23V119	19	237	34.50€
W23V121	21	257	38.10€
W23V122	22	257	38.10€
W23V124	24	287	44.60€

W25V1

Chaves de boca 3/8" com isolamento a 1 000V



Ref.	Medida (mm)	Compr. (mm)	Preço
W25V108	8	104	16.10€
W25V109	9	104	16.70€
W25V110	10	114	16.70€
W25V113	13	154	18.70€
W25V114	14	154	19.00€
W25V117	17	170	20.80€
W25V118	18	180	23.80€
W25V119	19	180	23.80€
W25V121	21	202	29.80€
W25V122	22	202	29.80€
W25V124	24	237	31.50€

W25V1125SV

634.30€

Tabuleiro EVA com ferramentas isoladas a 1 000V

Composição/ medidas em mm:

W23V11	9 Chaves luneta 10 a 19mm
W25V	13 Chaves bocas 7 a 24mm
PV0818	Alicate universal 200mm
PV1016	Alicate de corte 160mm
PV1116	Alicate de pontas 160mm



WV27AS10

62.50€

Chave ajustável isolada 1000V

Abertura: 33mm
Comprimento: 200mm





JONNESWAY®

Ferramentas Profissionais





JONNESWAY[®]

**Ferramenta Especial
Mecânica**



Mecânica



Chapeiro



Motociclos



Pesados

Ferramenta específica - ramo automóvel

AB030056

46.70€

Insuflador de ar para abertura de portas

Comprimento: 230mm



AB030061

28.70€

Ferramenta para retirar braço do limpa parabrisas



AE040020

81.00€

Cilindro hidráulico

Comprimento: 140mm fechado | 215mm estendido

Capacidade: 2t



AE040038

50.20€

Chave para fêmeas retenção cilindros hidráulicos

Abertura: 51 a 152mm

Quadra: 3/4

Pinos intermutáveis para orifícios de 1/4 e 5/16 de diâmetro



AE150005

135.10€

Par de preguiças de 3t com apoio em borracha

Altura máxima: 440mm

Altura mínima: 290mm



AE3000

Adaptadores para teste radiadores

Ref.	Preço
AE300064-02	24.40€
AE300064-03	24.40€
AE300064-04	25.00€
AE300064-05	25.20€
AE300064-06	19.60€
AE300064-07	19.70€
AE300064-15	29.50€
AE300064-16	29.50€



AE300064

287.40€

Kit teste de pressão para radiadores com 17 peças

Composição:

AE300064-02 Audi A4, A5, A6

AE300064-03 Opel, Ford, VW

AE300064-04 BMW

AE300064-05 BMW

AE300064-06 Volvo, Citroën, Renault, Fiat, Peugeot

AE300064-07 Audi, VW

AE300064-08 Sede ajustável

AE300064-09 Pino união 50mm

AE300064-10 Pino união 35mm

AE300064-11 Pino união 27mm

AE300064-12 Adaptador para 8; 9 e 11

AE300064-13 Adaptador

AE300064-14 Fixador

AE300064-15 Honda, Toyota

AE300064-16 Mitsubishi, Honda, Ford, Nissan, Mazda



AE300100-040

27.50€

Adaptador para kit de pressão de radiadores - Ford

Aplicável no kit AE300064



AE300100-042

27.50€

Adaptador para kit de pressão de radiadores - Ford

Aplicável no kit AE300064



AE300100-060

28.40€

Adaptador para kit de pressão de radiadores - Mercedes

Aplicável no kit AE300064



AE300103

22.50€

Aparadeira de chão para óleo

Dimensões: 600x450x180mm

Capacidade: 16l



AE300152

222.90€

Kit teste de pressão do radiador com 5 peças



AE300173

23.60€

Sangrador de fluido de embraiagem e travões
Fácil, rápido e eficiente utilizando o ar dos pneus



AE300176-A

49.40€

3 Adaptadores especiais para VW/ Audi/ Mercedes



AE300212

136.90€

Distribuidor de óleo de transmissões

Dimensões: 240x200x440mm
Capacidade: 4l
Peso: 1 600g
Bomba manual e 4 adaptadores



AE310002

327.80€

Conjunto de saca hidráulico com acessórios

Capacidade: 90-145mm



AE310002-RK

33.50€

Kit de reparação para AE310002



AE310006

117.00€

Conjunto de 2 extratores

Capacidade: 30-75mm



AE3100

Separadores meia lua

Ref.	Medida (mm)	Preço
AE310024	30-50	24.80€
AE310025	50-75	38.30€
AE310026	75-105	62.20€
AE310027	105-150	128.10€



AE310008

185.00€

Extrator interior e exterior

Capacidade: 15-30 e 30-80mm interna
15-80mm externa



AE310010A

147.70€

Jogo de extrator semieixo



AE310012

267.60€

Jogo de extrator interno para rolamentos cegos c/martelo deslizante

Um martelo deslizante e 4 abraçadeiras para extrair rolamentos. Abre as abraçadeiras girando a alavanca no sentido horário para encaixar no rolamento e puxar uniformemente sem danificar as peças.

Acessórios para:

3/8" a 1/2" (10-14 mm),
9/16" a 11/16" (15-19 mm),
5/8" a 1" (18-25mm),
1" a 1-1/4" (25-32mm)



AE310016

66.30€

Extrator semieixo



AN010045

12.30€

Separador de rótulas



AE310023

54.60€

Extrator de rótulas



AE310062

71.50€

Saca rolamentos longo

Comprimento: 300mm
Capacidade: 10-50mm



AE310063

85.60€

Saca para pequenos rolamentos

Especialmente indicado para remoção de pequenos rolamentos na área automôvel, reparação de equipamentos industriais e domésticos

Capacidade: 1t

Abertura: 19 a 45mm

Profundidade alcance: 73mm



AE310066

38.20€

Extrator para volantes de direção

Aplicável: Opel, Ford entre outros



AE310073

36.30€

Extrator de rótulas

Abertura: 20mm



AE310077

44.10€

Extrator de rótulas

Abertura: 20mm



AE310087

101.20€

Extrator universal de rótulas

Especialmente concebido para situações de utilização em espaço reduzido

Aplicável: Audi, VW, BMW, Ford, Mercedes (W170, W202, W210, W220), Opel, Mitsubishi ...



AE310099

138.40€

Extrator 7" de 2 ou 3 pernas para interiores e exteriores

Capacidade: 20t

Abertura: 76-178mm



Alterável para:



AE3100

Saca de 3 pernas



Ref.	Tamanho	Abertura (mm)	Capacidade (t)	Preço
AE310034	3"	40-76	2	23.50€
AE310035	4"	50-102	5	32.70€
AE310037	8"	80-203	12	123.20€
AE310038	12"	120-305	18	270.50€

AE3101

Extrator de rótulas



Ref.	Ø (mm)	Largura (mm)	Altura (mm)	Preço
AE310109A	18	40	35	23.20€
AE310110	23	50	45	50.50€
AE310112	40	80	80	101.20€

AE3101

Saca de 2 braços



Ref.	Ajuste Int. (mm)	Ajuste Ext. (mm)	Altura (mm)	Preço
AE310146B	25-80	70-130	100	66.90€
AE310146D	50-160	105-220	150	112.00€
AE310146E	60-200	120-270	150	149.90€
AE310146G	80-350	160-420	200	347.70€
AE310146H	110-520	195-600	200	511.50€



AE310122

108.50€

Extrator de rótulas

Abertura: 32mm



AE310135

107.20€

Saca de 2 braços

Indicado para extrair o rolamento da polie VW-AUDI
Com ponte de fixação e adaptador de aperto.

Abertura: 90mm

Altura: 100 mm

Força máxima de pressão: 1 ton.



AE310150

101.10€

Saca polies

Adaptado a todas as ranhuras das polies.

Para polies de alternadores, ar condicionado
e bombas de água.



AE310172

952.60€

Jogo de sacas

Composição:

Saca de 2ton

Pernas curtas: 85mm

Pernas compridas: 185mm

Saca de 6ton

Pernas curtas: 140mm

Pernas compridas: 280mm

Cilindro de 30ton



AE310172-1

96.50€

Separador meia lua p/saca AE310172



AE310180

321.80€

Jogo de saca rótulas com acessórios ajustáveis

Abertura: 20; 22; 24; 27 e 30mm



AE310183

146.80€

Removedor da barra de direção



AE320023

47.80€

Compressor de molas para amortecedores

Abertura: 270mm



AE320034

662.30€

Jogo de extrator de molas MacPherson



AE320044

84.50€

Compressor de molas para amortecedores

Abertura: 300mm



AE300154B

137.10€

Refratómetro

Aparelho apto para testar líquido de baterias, líquido refrigerante e AdBlue



AE300168
114.80€
Verificador de fugas da cabeça do cilindro

Equipamento destinado a verificar fugas na combustão. A utilização de líquido contrastante permite verificar a existência de dióxido de carbono no depósito do líquido de refrigeração, denunciando assim a existência de fugas na combustão.

AE300168-1
51.70€
Líquido para verificador da cabeça do cilindro

Embalagem de 250ml

AI020074
172.80€
Detector de fugas para cilindros

AE300201
149.70€
Pistola tornado vaporizadora

Dimensões: 330x105x270mm
 Capacidade copo: 1l
 Peso: 780g
 Ruído: 85dB
 Alimentação: 6,2bar
 Consumo de ar: 56,6l/min
 Entrada de ar: 1/4"

AE300202
143.90€
Pistola tornado vaporizadora/ espuma

Dimensões: 330x105x260mm
 Capacidade copo: 1l
 Peso: 950g
 Ruído: 70dB
 Alimentação: 6,2bar
 Entrada de ar: 1/4"
 Consumo de ar: 56,6l/min

AE300204
26.80€
Seringa para fluidos

Fabricado em plástico resistente a fluido travões e anticongelante. Permite sucção, adição e visualização do fluido

Capacidade: 200cc
 Peso: 294g

**NÃO
utilizar com
combustíveis**

AE300205
58.40€
Seringa para fluidos

Fabricado em plástico resistente a fluido travões e anticongelante. Permite sucção, adição e visualização do fluido

Capacidade: 1,5l
 Peso: 900g

Aplicação: óleo da caixa velocidades e diferenciais

**NÃO
utilizar com
combustíveis**

AE300211
105.90€
Seringa para fluidos com 5 adaptadores

Fabricado em plástico resistente e aplicável a todos os tipos de óleos e combustíveis. Permite sucção, adição e visualização do fluido.

Capacidade: 1,5l

AE300206
18.90€
Base de recolha de óleos para latas 20/ 30l

Concebido para recolha de restos de óleo de filtros, novo ou usado, e outros recipientes (encaixe direto em latas de 20/ 30l)
 Fabricado em polietileno resistente de alta densidade

Capacidade: 3l
 Peso: 500g
 Diâmetro: 350mm

AE300207
64.30€
Base de recolha de óleos para bidons 200l

Concebido para recolha de restos de óleo de filtros, novo ou usado, e outros recipientes (encaixe direto no topo de bidons de 200l)
 Fabricado em polietileno resistente de alta densidade

Capacidade: 20l
 Peso: 1 700g
 Diâmetro: 600mm



AE300215

44.50€

Pistola de limpeza de motores

Bico ajustável
Capacidade: 1l
Consumo de ar: 160 l/m
Entrada de ar: 1/4"
Pressão de trabalho: 5-8 Bar



AE300220

97.60€

Escorredor de resíduos de óleo

Dimensões: 174x197x486mm
Capacidade: 2l



AG010034

7.20€

Caneta magnética

Comprimento: 580mm



AG010035

30.20€

Pesca magnético com luz e espelho



AG010163A

9.70€

Pesca magnético flexível



AG010164

47.60€

Kit de pesca magnético com luz e espelho

Luz: branca, azul e UV



AG010036

13.00€

Bandeja magnética redonda

Dimensões: Ø 150mm



AG010111

33.30€

Bandeja magnética retangular

Dimensões: 240x140mm



AG010046

12.50€

Ponteira para válvulas dos pneus

Comprimento: 230mm



AG010049

11.40€

Jogo de 5 saca pernos



AG010059

38.00€

Jogo de 4 saca casquilhos

Medidas: 6; 8; 10 e 12mm



AG010059

Saca casquilhos

Ref.	Medida (mm)	Preço
AG010059-6	6	8.20€
AG010059-8	8	8.20€
AG010059-10	10	9.10€
AG010059-12	12	8.60€

AG010089

20.20€

Medidor digital de pressão de ar

Baterias de lítio
Visor LCD
Auto calibração
Auto off



AG010159
8.60€
Ponteira para mangueira de ar dos pneus

Ponteira: 6mm

AG010207
93.60€
Gambiarra de Leds

Inclui: Carregador 220v AC/ 5v DC e cabo USB

Dimensões: 375x30x30mm

Potência: 15W

Carregador: 220v/ 50Hz

Capacidade da bateria: 2,5 a 10h

Fluxo luminoso: 410 lumen

Tempo de carga: 3,5 a 4h

Iluminância máxima: 935 lux projetada a 50cm

Bateria recarregável: Li-ion 3,7v 2 200mAh

AG010224
86.10€
Gambiarra flexível de Leds

Comprimento: 168mm

Bateria: Li-ion 3,7v - 2.2Ah

Carregador: AC/DC

Haste flexível 360°

Base magnética

Regulador de intensidade

Autonomia: 2 a 8h (variável conforme intensidade)

AS-0065
47.50€
Suporte magnético para máquina de impacto e 4 chaves

C-DM1
29.50€
Barra magnética

Dimensões: 475x52x17mm

AG010099
40.60€
Chaves de cruz para porcas de rodas

Medidas: 17; 19 e 21mm

AG010225
33.40€
Chave de rodas com 3 peças

Pode ser utilizado em + ou em "T"

Medidas: 17; 19 e 21mm

Tubo perfurado 355mm com chave de 19 e 21mm

Tubo perfurado 395mm com chave de 17mm

Adaptador 1/2"

AG01016
Chave de rodas dupla

Ref.	Medida (mm)	Dimensão (mm)	Preço
AG010167	24x27	3/4" x 600	52.30€
AG010168	30x32	3/4" x 600	58.80€
AG010169	32x33	3/4" x 600	61.90€

AG010109
28.10€
Quebra porcas

Medidas: 12-18 e 16-22mm

AG010118A
29.70€
Medidor angular de torque 1/2"

AG010147
16.10€
Chave de aperto angular de torque 1/2"

AG10001SP-G
5.10€
Medidor de passo de rosca

AG010208

66.10€

Jogo de extratores de parafusos torx danificados com 8 peças

Composição:

Medida (mm)	Compr. (mm)	Hex (mm)
3	38	10
4	38	10
5	38	10
6	38	10
7	38	12
8	38	12
10	38	14
12	38	14



AG010227

356.60€

Jogo de machos e caçonetos com 53 peças

Composição:

- 15 Machos 38mm: M6x0,75; M6x1,0; M8x1,0; M8x1,25; M10x1,25; M10x1,5; M12x1,25; M12x1,5; M12x1,75; M14x1,5; M14x2,0; M16x1,5; M16x2,0; M18x1,5 e M18x2,5
- 6 Machos 50mm: M20x1,5; M20x2,5; M22x1,6; M22x2,5; M24x1,5 e M24x3,0
- 21 Caçonetos: M6x0,75; M6x1,0; M8x1,0; M8x1,25; M10x1,25; M10x1,5; M12x1,25; M12x1,5; M12x1,75; M14x1,5; M14x2,0; M16x1,5; M16x2,0; M18x1,5; M18x2,5; M20x1,5; M20x2,5; M22x1,5; M22x2,5; M24x1,5 e M24x3,0

5 Extratores

1 Porta caçonetos

1 Desandador de machos (M6 - M25)

1 Desandador de machos (M4 - M12)

1 Chave phillips PH2 38mm

2 Adaptadores de Ø 50mm



AG010229

168.90€

Jogo de machos e caçonetos com 50 peças

Composição:

- 22 Machos + 22 Caçonetos: M3x0,5; M3x0,6; M4x0,7; M4x0,75; M5x0,8; M5x0,9; M6x0,75; M6x1,0; M7x0,75; M7x1,0; M8x1,0; M8x1,25; M9x1,0; M9x1,25; M10x1,0; M10x1,25; M10x1,5; M11x1,5; M12x1,25; M12x1,5; M12x1,75 e 1/8NPT27

1 Desandador de machos M6 - M12

1 Desandador em "T" para machos

1 Porta caçonetos

1 Chave phillips

1 Medidor passo rosca

1 Punção



AG10001SP-T

4.30€

Desandador em T para machos



AG10001SP-D

9.20€

Porta caçonetos



AG10001SP-W

10.30€

Desandador macho extensível

Medidas: M4 a M12



AG10002SC-W

7.10€

Desandador macho extensível

Medidas: M3 a M12



AH020002

28.90€

Proteção de guarda-lamas com fixação magnética

Dimensões: 1 050x650mm



AI010006

33.30€

Ferramenta para bloqueio de polias e carretos

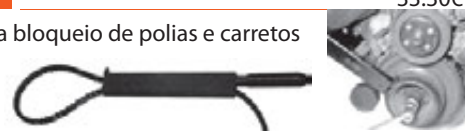

AI010009

30.40€

Ferramenta para limpeza das ranhuras de segmentos

Com 3 lâminas circulares para limpeza de pistões (diâmetro: 51 a 127mm)

Lâmina 1: 1/16"; 5/64"; 3/32"; 1/8"; 5/32" e 3/16"

Lâmina 2: 2; 2,5; 3; 4; 4,5mm e 1/4"

Lâmina 3: 1,2; 1,5; 1,8; 2,8; 5 e 5,5mm



AI010017
167.10€
Régua de verificação de empenos do motor

AI010023
16.90€
Esticador de correias

AI010029
86.10€
Saca carretos e polias

AI010030
111.40€
Chave bloqueio da polie da árvore de cames

AI010060
80.10€
Jogo de 4 chaves para injetores 1/2"

Composição:

	Faces	Diâmetro (mm)	Medida (mm)
A	6	22	110
B	12	22	75
C	12	27	78
D	12	28	78

AI010060-A
22.70€
Chaves para injetores 1/2"

 Faces: 6
 Diâmetro: 22mm
 Medida: 110mm

AI010037
111.60€
Kit comando de motores com 8 peças

Composição:

Marca	Modelo	Aplicação
OPEL	Astra Vectra	G 1.7 TD; 2.0 16V 1.8; 2.0 16V >1995
OPEL	Astra Vectra Zafira	G 1.4 ; 1.6; 1.8 16V 1.6; 1.8 16V 1.6; 1.8 16V

Árvore de cames à direita

SAAB	900 - 9000	
OPEL	Calibra Cavalier Omega-B Sintra Vectra	2.5; 2.5L; 2.6 V6 2.5L V6 2.5; 2.5L; 2.6 V6 2.5; 2.6; 3.0; 3.2; V6 3.0 V6 2.5L; 2.6 V6

Árvore de cames à esquerda

SAAB	900 - 9000	
OPEL	Calibra Cavalier Omega-B Sintra Vectra	2.5; 2.5L; 2.6 V6 2.5L V6 2.5; 2.5L; 2.6 V6 2.5; 2.6; 3.0; 3.2; V6 3.0 V6 2.5L; 2.6 V6

ROVER

25	1.4; 1.6; 1.8VVC
45	1.4; 1.6; 1.8
75	1.8
200	VI
214	16V
216	16V; Cabrio; Coupé
218	Coupé
414	16V
416	16V; BRM 1.8VVC

VOLKSWAGEN

Bora	1.9 TDI
Golf	1.9 TDI
Lupo	1.2; 1.4; 3.0 TDI
Polo	1.4 TDI
Passat	1.9 TFI

CITROËN

Berlingo	1.9 D
Jumper	1.9 D; TD-FSO 1.9D;
Jumpy	1.9 D/TD
Synergie	1.9; 2.0 T
Xantia	1.9; 2.0 D; TD; HDI
Xsara	1.9; 2.0 D; TD; HDI

FIAT

Ducato	2.0 D
Ulysse	1.8; 2.0 Turbo

FORD

Maioria dos Motores Diesel	
----------------------------	--

PEUGEOT

205	1.6; 1.8; 1.9 D
305	1.6; 1.8; 1.9 D
306	1.8; 1.9 D; TD
309	1.6; 1.9 D
405	1.6; 1.9 D
406	1.9 D
605	2.0 D; TD
806	1.9 D
Boxer	1.9; 2.0 D; TD
Expert	1.9 D
Partner	1.9 D

TALBOT

Express	D
Horizon	D-J5D
Solara	D

ISUZU

Motores Diesel	1.5; 1.7
----------------	----------

OPEL

Motores Diesel	1.6; 1.7
Motores Gasolina	1.2; 1.4; 1.6; 1.8; 2.0

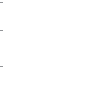

AI010041

130.10€

Kit comando de motores com 19 peças

Composição:

Marca	Modelo	Motorização	
CITROËN	Synergie	2.0/Turbo; ZX 1.9D/TD	
	Xantia	1.9D/TD	
	Berlingo	1.9D	
FIAT	Ulisses	2.0/Turbo	
	Ducato	2.0	
FORD	Fiesta	1.25; 1.4 (95-); 1.8-XR2i/RS1800 16V	
	Mondeo	1.6; 1.8; 2.0 16V (93-)	
	Escort/Orion	1.6; 1.8i 16V (92-)	
HONDA	Accord/Prelude	2.3i (93-);	
	Prelude	2.2 V-Tec; motor SOHC	
	Accord	1.8, 2.0; 2.2 (-93); 2.0i (93-)	
	Shuttle	2.2i;	
	Civic	1.6 VTI	
	Accord	(90-)	
LAND ROVER	Discovery MPi	2.0 16V (93-), motor 20T4	
	MAZDA	121	1.25
OPEL	Cavalier	2.5	
	Calibra	2.5	
	Vectra	2.5	
	Omega	2.5; 3.0	
	Sintra	3.0	
	Astra	1.8; 2.0 16V	
	Cavalier	2.0 16V	
	Calibra	2.0 16V/Turbo	
	Omega-B	1.6 16V	
	Motor Gasolina OHC	1.2; 1.4; 1.6; 1.8; 2.0	
	Motor Diesel OHC	1.6D i; 1.7D	
	Motor Diesel OHC		
	Diesel Isuzu	1.5D i; 1.7D	
	PEUGEOT	205; 305; 309; 405	1.6; 1.9
		405	1.8; 2.0 (92-)
		605	2.0
		Boxer	2.0
		205; 305	1.8; 1.9D
		306	1.8; 1.9D/TD
309		1.8; 1.9D; 1.8TD	
405		1.8TD; 1.9D	
406		1.9D	
Partner		1.9D	
Talbot/Horizon/Solara		1.9D	
J5/Talbot Express		1.9D	
RENAULT		605	1.9D/TD
	806	1.9TD	
	Expert	1.9D	
	Boxer	1.9D/TD	
	R5	1.6D	
	R9	1.6D	
	411	1.6D	
	Express/Extra	1.6D - motores Diesel F8M	
	Clio; Express/Extra		
	R19	1.9D - motor diesel F8Q	
	Espace	2.1D	
	R21	2.1D	
	R25	2.1D	
	Trafic/Master	2.1D - motor Diesel J8S	
	Clio	1.2; 1.4	
	Express/Extra	R19 1.4	
	Megane/Scenic	1.4; 1.6 - motor E7F/E7J	
	R5	1.7	
	Clio	1.7; 1.8	
R19	1.7		
R21	1.7		
Megane/Scenic	2.0		
Laguna	1.8; 2.0		
Trafic	1.7 - motor F3N; F3P; F2R		
Clio Williams; R19; Megane	2.0 16V - motor F7P; F7R;		
Laguna/Safrane	2.0 16V - motor N7Q/N7U		
ROVER	623	(93-)	
	618/620	motor SOHC (93-)	
	216; 416	GTi 16V (-95) motor D16A9, motor K16 DOHC; motor SOHC 820.8V (m8)	
	Metro	GTa/GTi 16V K16 (-95)	
	214; 414	K16(89-)	
	216; 416	K16 (95-)	
	MGF	1.8 MPi/VVC (95-)	
	220	M16 (-92)	
	220	Turbo T16 (92-)	
	420	M16 (-92)	
	420	T16 (92-)	
320	Turbo M16 (-91)		
620	Ti (94-)		
820	Turbo T16 Vitesse (91-)		
SAAB	900	2.5	
	9000	3.0 V6	
	VW; AUDI; SEAT; SKODA	TDI desde 2000	
	ECOTEC 1.4; 1.6; 1.8; 2.0 16V		



AI010060-B

19.90€

Chaves para injetores 1/2"

Faces: 12
Diâmetro: 22mm
Medida: 75mm



AI010060-C

18.20€

Chaves para injetores 1/2"

Faces: 12
Diâmetro: 27mm
Medida: 78mm



AI010060-D

18.40€

Chaves para injetores 1/2"

Faces: 12
Diâmetro: 28mm
Medida: 78mm



AI010063A

65.50€

Medidor de tensão de correias



AI010086

157.20€

Jogo de 12 chaves para terminais



AI010092

92.70€

Bloqueador do volante do motor



AI010104

45.60€

Ferramenta para retirar a tampa do depósito de combustível

Ajustável entre 122-199mm



AI010127
7.20€
Chave de remoção da correia trapezoidal

Aplicação: VOLVO e grupo VAG

AI010137
51.80€
Organizador para peças desmontadas

AI010090A
105.40€
Jogo de 22 chaves para alternador

AI010166
10.30€
Chave torx para polie alternador 1/2"

Medida: T50

Comprimento: 110mm

AI010167
11.70€
Chave XZN para polie alternador 1/2"

Medida: M10

Comprimento: 110mm

AI010176
49.70€
Chave de remoção do filtro de combustível

Esta ferramenta torna a tarefa rápida e fácil de executar reduzindo os riscos de danificar o alojamento plástico do filtro.

Composição:

Marca	Modelo	Aplicação
CHEVROLET	Captiva, Epica	2.0 VCDi
CITROËN	Hdi Relay	2.0; 2.2; 2.8; 3.0
FIAT	500; Doblo; Strada; Idea; Panda; Punto	1.3 JTD
	Idea; Multipla; Punto; Sedici (+2.0 JTD)	1.9 JTD
	Ducato	2.0; 2.2; 2.3; 2.8; 3.0 JTD
LANCIA	Musa; Ypsilon	1.3 MJTD
OPEL	Agila; Astra; Corsa; Combo; Meriva; Tigra	1.3 CDTi
	Astra; Signum; Vectra; Zafira	1.9 CDTi
PEUGEOT	Boxer	2.0; 2.2; 2.8; 3.0 HDi
SAAB	9-3	1.9 TiD
SUZUKI	Splash; Swift; SX4	1.3 DDiS

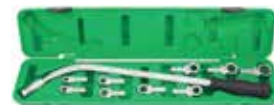
AI010195
130.00€
Chave tensionadora de correias com 10 peças

AI020015
27.80€
Grampo para válvulas

Capacidade: 60-120mm

Altura: 150mm

AI0200
Grampo para segmentos

Ref. Capacidade (mm)

AI020019 115-180

AI020020 70-108

AI020021 50-100

Preço

32.80€
25.70€
24.40€

AI020024
101.10€
Grampo para válvulas

Para motores grandes/ diesel

AI020025
84.90€
Grampo para válvulas

Capacidade: 55-175mm

AI020027
37.80€
Desmonta válvulas universal com gancho

Compressor molas de válvulas

AI020047
27.40€
Extrator das juntas das válvulas

AI020048

Grampo para segmentos

Ref.	Capacidade (mm)	Altura (mm)	Preço
AI020048A	57-125	82	18.50€
AI020048D	90-175	100	20.20€
AI020048E	90-175	165	34.40€



AI020043

Alicate para abraçadeiras de folos



23.40€

AI020049

Grampo universal para válvulas



93.10€

AI020051

Kit teste de compressão para motores a diesel

BMW, CITROËN, DACIA, DAF, DAIHATSU, FIAT, FORD, ISUZU, LAND ROVER, MAZDA, MERCEDES, MITSUBISHI; NISSAN, OPEL, PEUGEOT, RENAULT, ROVER, SEAT, TOYOTA, VOLKSWAGEN, VOLVO

Manómetro: 0-70bar

Diâmetro: 80mm

Turbo: 355mm

Adaptadores:

M10x1 (73,5mm); M10x1 (114,5mm);

M10x1 (119mm); M12x1,25 (54mm);

M14x1,25 (72mm) e M20x1,5 (78mm)

Simulador bucal 19 e 21 mm



266.30€

AI020052

Kit teste de medição compressão em motores a gasolina

Inclui adaptadores e reparadores com rosca

Medidas: M10; M12; M14 e M18



178.30€

AI020054

Kit teste para a pressão do óleo

Inclui adaptadores e reparadores com rosca

Manómetro: 0-10bar/80mm

Turbo: 1 300mm

Jogo de 10 adaptadores



186.10€

AI020056A

Alicate para juntas de válvulas



28.50€

AI020066

Alicates cinta de segmentos

Abertura: 73-111mm



95.40€

AI020101A

Dispositivo para teste de injetores common rail diesel

Este dispositivo permite medir rápida e eficientemente a quantidade de combustível de retorno de cada injetor, permitindo assim verificar se existe alguma anomalia. Medição até 6 injetores em simultâneo.

Inclui adaptadores para injetores Bosch, Delphi, Denso e Siemens.



158.30€

AI020101A-A

Jogo de copos de substituição para AI020101A



58.90€

AI020103
64.60€
Extrator de inércia para desmontagem de injetores

Feito de aço endurecido de alta qualidade.

Desmontagem rápida e fácil de injetores presos em motores a diesel.

Preparado para rosca M8; M12 e M14

AI020158
122.00€
Jogo de 150 anilhas de cobre para injetores com 15 medidas

Composição:

 13,85x7,3x1,4; 14,60x7,5x1,3; 14,60x7,5x3,0; 15x7x2;
 15x7,5x1; 15x7,5x1,5; 15x7,5x2; 15x7,5x2,5; 15x7,5x3;
 15,5x7,5x2; 16x7,5x1,5; 16x7,5x1,7; 16x7,5x2; 16x7,4x2
 e 20x9,4x0,9

AI020107
202.70€
Ferramenta de ajuste do ponto de injeção

Permite efetuar o ajuste do ponto de injeção em motores diesel com bomba injetora convencional.

Aplicável entre outros em veículos ALFA ROMEO, AUDI, BMW, FIAT, FORD, ISUZU, IVECO, LANCIA, LAND ROVER, MITSUBISHI, NISSAN, RENAULT, ROVER E VOLKSWAGEN.

AI020109
97.70€
Jogo de 6 chaves para velas de incandescência

Composição/ medidas (mm):

Chaves: 8; 9; 10; 12; 14 e 16

Comprimento: 160mm

AI020131
146.80€
Compressor de molas de válvulas

AI020142
443.00€
Jogo de saca rolamentos pequenos

Composição/ medidas (mm):

Saca

Barra

Expansores: 6 a 8; 8 a 10; 12 a 15 e 15 a 18

AI020162
28.00€
Alicate de pontas direitas para remoção de relays

AI020163
27.40€
Alicate de pontas angulares para remoção de relays

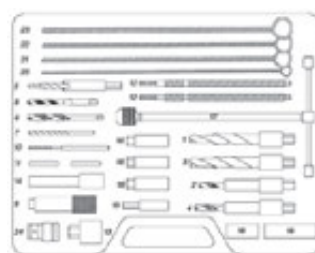
AI020178
389.10€
Kit remoção de velas de incandescência danificadas

AI020180
143.90€
Teste de sistemas turbo

Este kit pela insuflação de ar comprimido de baixa pressão no sistema do turbo, permite a verificação de fugas.

Composição: 4 pares de adaptadores

Ø	Medida (mm)
55-60	64
65-70	74
75-80	84
85-90	94



AI020184 17.80€

Chave para injetores MERCEDES BENZ

Quadra: 1/2"
Medida: 17mm
Comprimento: 119mm



AI020184A 17.30€

Chave para injetores BMW e Volkswagen

Quadra: 1/2"
Medida: 14mm
Comprimento: 119mm



AI020184B 19.00€

Chave para injetores MERCEDES BENZ

Quadra: 1/2"
Medida: 19mm
Comprimento: 119mm



AI020184S 53.40€

Jogo de 3 chaves 1/2" para linha de injeção

Composição:

Ref.	Medida (mm)	Aplicação
AI020184A	14	BMW; VW
AI0200184	17	Mercedes 100, 130, 314, 360, 360h, 352A, 346/355, 401, 402, 403, 407h, 615, 616 e 617
AI0200184B	19	Mercedes 314, 352, A, 346/355, A, 401, 402/422, LA, 403, 407



AI020185 22.90€

Chave luneta aberta dobrada

Chave especial para desmontar tubos de alta pressão do sistema de combustível em motores a diesel
Medidas: 17x17mm



AI020201 79.70€

Jogo de 6 chaves de caixa com luneta aberta

Especialmente concebidas para trabalhar em espaços apertados e de difícil acesso.

Quadra: 1/2"
Comprimento: 100mm
Medidas: 12; 14; 16; 17; 18 e 19mm



AI020205 147.40€

Saca para injetores (diesel/ gasolina)

Saca especialmente concebido para a remoção de injetores Diesel e Gasolina. As garras são intermutáveis o que permite abranger um maior número de tipos de injetores.



AI030007 23.40€

Jogo de 5 peças para raspar, limpar e tirar juntas



AI050043S 25.40€

Jogo de 3 raspadores

Medidas: 15; 20 e 30mm



AI030010 5.20€

Ferramenta para rodar válvulas grandes



AI030011 4.80€

Ferramenta para rodar válvulas pequenas



AI030020 23.20€

Estetoscópio de mecânico



AI030025 7.60€

Jogo de riscador/ tira o-rings e juntas



AI030027

50.70€

Jogo de 6 riscadores com punho



AI040007

15.10€

Alicate para segmentos
Medidas: 1,2 a 6,3mm



AI040008

116.20€

Kit completo para teste de vácuo e sangrar travões



AI040031

166.90€

Bomba para vácuo e pressão com kit sangrador travões
Selecionar a válvula de controlo para a função de vácuo ou pressão.



AI040005

21.40€

Alicate de pontas curvas para anéis de segurança



AI040006

21.40€

Alicate de pontas direitas para anéis de segurança



AI040011

18.80€

Alicate para velas com pontas isoladas



AI040017

69.60€

Jogo de alicates de freios de cabeças recambiáveis

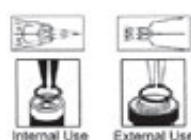

AI040018

26.50€

Alicate para abraçadeiras



AI010201

104.80€

Chave flexível para tubos de combustível
Permite trabalhar em locais com pouco espaço.



AI040060

34.10€

Alicate para tubos de combustível

Alicate para ligações rápidas de tubos de combustível.



AI040064

40.60€

Alicate para freios de segurança (sem ilhós/furos)

Indicado especialmente para:
Citroën, Peugeot, Renault e Nissan



AI040246

51.60€

Jogo para desligar tubos de combustível

Composição:

- 1 Chave direita para tubos 11,8mm
- 1 Chave direita para tubos 16mm
- 1 Chave angular para tubos 11,8mm
- 1 Chave angular para tubos 16mm



AI030002

34.50€

Jogo de 11 chaves para bujões óleo

Quadra: 3/4"

Utilização: chave de caixa 19mm

Hexagonais

8mm: BMW/ FORD/ GM

9mm: GM

10mm: FORD

12mm: FIAT/ LANCIA/ PEUGEOT/

14mm: LANCIA/ MERCEDES

17mm: AUDI/ BMW/ DAC

Quadradas + cabo

8mm: PSA/ RENAULT/ VOLVO

9,5mm: HONDA/ MAZDA/ PEUGEOT/ SAAB/ VOLVO

11mm: FORD

13mm: NISSAN/ SUBARU



AI050004

68.70€

Jogo de 15 peças de copo para filtros

Composição:

Faces	Medidas (mm)	Aplicação
14	65	GM, DAIHATSU, TOYOTA
14	65-67	DAIHATSU
14	68	MAZDA, FORD ESCORT, SUBARU
14	73	TOYOTA, LEXUS
15	74-76	SATURN
15	75-77	VW, AUDI, FORD, ISUZU, MERCEDES, OPEL
14	76	VW, PORSCHE, MERCEDES, BMW, AUDI A3, OPEL
30	76	FORD
15	80	NISSAN, HONDA, MAZDA, ISUZU, SUBARU, OPEL, TOYOTA
15	80-82	MAZDA, SUBARU, TOYOTA, HONDA, ACURA, NISSAN
15	90	HONDA ACCORD, MITSUBISHI, ISUZU
15	93	OPEL, MAZDA, VOLVO, MITSUBISHI, NISSAN, VW, PORSCHE, RENAULT, FORD, HONDA, AUDI
36	93	FORD
15	100	ISUZU, MITSUBISHI

Adaptador 1/2" (F)x3/8"(M)





HC

Chaves de copo para filtros

Ref.	Faces (mm)	Medida (mm)	Preço
HC-100/15	15	100	6.10€
HC-106/15	15	106	6.40€
HC-108/15	15	108	5.60€
HC-108/18	18	108	6.00€
HC-65/14	14	65	6.00€
HC-65/67	14	65-67	5.80€
HC-65103		65-120	20.30€
HC-66/6	6	66	5.70€
HC-68/14	14	68	5.50€
HC-73/14	14	73	6.00€
HC-74/15	15	74	6.00€
HC-74/76	15	74-76	6.20€
HC-75/77	15	75-77	6.20€
HC-76/12	12	76	6.00€
HC-76/14	14	76	6.00€
HC-76/30	30	76	6.00€
HC-76/8	8	76	5.80€
HC-78/15	15	78	5.90€
HC-80/15	15	80	6.00€
HC-80/82	15	80-82	5.60€
HC-86/16	16	86	6.10€
HC-86/18	18	86	6.00€
HC-9.5mm	adaptadores 1/2"-3/8"		2.40€
HC-90/15	15	90	6.10€
HC-92/10	10	92	6.10€
HC-93/15	15	93	6.10€
HC-93/36	36	93	6.00€
HC-93/45	45	93	6.10€
HC-95/15	15	95	6.20€
HC-96/18	18	96	6.00€



AI050004A

161.00€

Jogo de 30 peças de copo para filtros

Composição:

Faces	Medida (mm)	Aplicação
14	65	GM, DAIHATSU, TOYOTA
14	65-67	DAIHATSU
14	68	MAZDA, FORD ESCORT, SUBARU
14	73	TOYOTA, LEXUS
15	74	AUDI, GM, ROVER, CHRYSLER
15	74-76	SATURN
15	75-77	VW, AUDI, FORD, ISUZU, MERCEDES, OPEL
8	76	FIAT MAREA, LANCIA DELTA
12	76	FIAT (DUCATO, SCUDO, ULYSSE), RENAULT (MEGANE, LAGUNA, ESPACE)
14	76	VW, PORSCHE, MERCEDES, BMW, AUDI A3, OPEL
30	76	FORD
15	78	NISSAN, FORD, TOYOTA
15	80	NISSAN, HONDA, MAZDA, ISUZU, SUBARU, OPEL, TOYOTA
15	80-82	MAZDA, SUBARU, TOYOTA, HONDA, ACURA, NISSAN
16	86	VOLVO (S40, S60, S70, S80)
18	86	VW (GOLF TDI, PASSAT/TDI), AUDI A6 TDI, RENAULT (CLIO, RAPID 1.9D, LAGUNA, SAFRANE, ESPACE 2.1D, CITROEN; PEUGEOT
15	90	HONDA ACCORD, MITSUBISHI, ISUZU
10	92	FIAT (CINQUECENTO, COUPE, CROMA, PANDA, REGATA, RITMO, SEICENTO, TEMPRA, TIPO), LANCIA (BETA, DEDRA, KAPPA, THEMA)
15	93	OPEL, MAZDA, VOLVO, MITSUBISHI, NISSAN, VW, PORSCHE, RENAULT, FORD, HONDA, AUDI
36	93	FORD
45	93	VW, AUDI (2.4; 2.6; 2.8L)
15	95	TOYOTA, ALFA, GM, FORD, CHRYSLER
18	96	AUDI (A4, A6TDI), VW (PASSAT 97 TDI), RENAULT (LAGUNA 2.2D, SAFRANE 2.2D, ESPACE 2.2D, R19, RAPID, MEGANE 1.9/2.1D)
15	100	ISUZU, MITSUBISHI
15	106	FIAT DUCATO 2.5 TD
18	108	RENAULT (ESPACE, LAGUNA,
15	108	MASTER, SAFRANE, TRAFFIC 2.4; 2.5; 2.8D)

Chave filtro de óleo ajustável 65-120
Adaptador 1/2"(F)x3/8"(M)



AI050009A

10.50€

Chave de filtros



AI050008-10

15.40€

Chave de filtros

Ajustável: 55-85mm



AI050024

25.50€

Jogo de 4 alavancas

Medidas: 200; 330; 540 e 600mm



AI050001

24.50€

Chave de filtros de 3 pernas

Capacidade: 60-120mm



AI050037

23.20€

Chave de filtros de 3 pernas

Capacidade: 45-110mm



AI030067

51.00€

Jogo de 17 chaves para bujões de óleo 3/8"

Composição:

6 Chaves hexagonais: 8; 9; 10; 11; 12; 13 e 14mm

9 Chaves quadradas: 7; 8; 10; 11; 12; 13 e 14mm 5/16" e 3/8"

1 Chave quadrada (fêmea): 10mm

1 Chave triangular



AI050040

13.30€

Chave para bujões

Medidas: 8 e 10mm



AI050042

22.60€

Chave para remoção de ventoinha

Medidas: 8 e 10 mm



AI050043

23.60€

Alicate de pressão para filtros de óleo

Medida: 53-118mm



AI050175

21.50€

Chave para remover/ instalar o alojamento plástico dos filtros de óleo

Aplicação: Motores TDCI - HDI - Ford, Peugeot, Citroën



AI050076

66.30€

Chave de filtros ajustável 1/2"

Medida: 60-80mm



AI050077

21.40€

Chave de filtros de cinta

Medida: 25-160mm



AI050080

11.90€

Chave para parafusos cabeça do motor 1/2"

Medida: M9

Comprimento: 100mm



AN010030

17.30€

Alicate para remoção de pesos de rodas



AN01009A

8.60€

Chave para bujões de carter

Medidas (mm): 10; 11; 12; 13; 14; 15 e 17mm

Comprimento: 150mm



AI05009

Chave de velas longa 3/8"

Ref.	Medida (mm)	Compr. (mm)	Preço
AI050092	14	250	19.50€
AI050093	16	250	21.50€

AI040038

Chave Velas VAS, Mercedes, Smart

AI050096S

63.80€

Jogo de 7 chaves especiais

Sensores de vácuo e de oxigênio e válvulas pressostáticas

Chave da unidade emissora de pressão de óleo de 1" e 1-1/16"

Chave da unidade emissora de pressão de óleo de 1-3/16"

Chave do interruptor do sensor térmico GM de 1-1/16"

Chave do sensor de oxigênio 7/8"

Chave do sensor de oxigênio offset de baixo perfil de 7/8"

Chave do sensor de oxigênio de 7/8"

Adaptador vácuo universal PVS, válvula TVS e

Chave do sensor de oxigênio 7/8"

AI050102

95.40€

Chave de filtros 3 pernas auto ajustáveis

Capacidade: 95-165mm

AI050202

11.60€

Chave de copo para filtros de 14 faces 3/8" com 64,5mm

Marca	Modelo	Motorização
TOYOTA	Auris/ Corolla/ Prius	1.8/ 2.0 4 cilindros

Novo
AI050140A

27.40€

Chave de alumínio copo para filtros de 14 faces 3/8" com 64,5mm

AI010033

8.60€

Chave para sensor de oxigênio

AI050104

25.90€

Chave para sensor de oxigênio

Medida: 22mm

AI050109

58.90€

Chave de filtros de corrente

Comprimento: 350mm

Filtros: 60 a 105mm

AI050110

63.50€

Chave de filtros de corrente

Comprimento da corrente: 520mm

Filtros: 60-165mm

AI050113

227.40€

Jogo de bits impacto de 3/4" e 1"

Composição/ medidas (mm):

5 Chaves torx T60, T70, T80, T90 e T100 (107mm)

4 Chaves hexagonais 17, 19, 22 e 24mm (107mm)

4 Chaves torx E18, E20, E22 e E24 (107mm)

1 Chave sextavada 3/4" 22mm

1 Chave sextavada 1" 22mm

1 Chave hexagonal em L 4mm

AI050152

25.20€

Tubo para descarga de óleo usado do alojamento do filtro

AI050152A

15.30€

Tubo para descarga de óleo usado do alojamento do filtro

Aplicação: TOYOTA e LEXUS



AI050191 15.10€

Chave magnética para bujões



AI050176 229.00€

Kit para montagem de correias estriadas com 11 peças

Composição:

Marca	Modelo
AUDI	A3
BMW	118/ 120/ 318/ 325/ 330/ 335/ 520/ 525/ 530/ 535/ 635/ 720/ 730/ X3/ X5
CITROËN	C2/ C3/ C4/ Jumper/ Relay
CHRYSLER	Grand Voyager/ Voyager
FIAT	Albea/ Doblo/ Ducato/ Fiorino/ Marea/ Multipla/ Qubo/ Linea/ Palio/ Siena/ Stilo e Strada
FORD	C-Max/ Courie/ Fiesta/ Focus C-Max/ Fusion/ Mondeo/ Tourneo/ Transit
IVECO	Daily
LANCIA	Lybra
MAZDA	2/ 3/ 5/ Axela
MERCEDES	Sprinter/ Viano/ Vito
MITSUBISHI	ASX
PEUGEOT	206/ 207/ 307/ Boxer
SEAT	Altea/ Ibiza
SKODA	Octavia/ Yeti
VOLKSWAGEN	EOS/ Golf/ Passat/ Polo/ Sirocco
VOLVO	C30/ S40/ V50



AL010093 39.20€

Ferramenta para montagem/ desmontagem de correias elásticas poli-v



AE300180 56.00€

Funil para líquido refrigerante

Dimensões: 160x160x260mm
Funil + 2 adaptadores



AE300179-02 49.00€

Adaptadores para funil líquido refrigerante AE300180



AE300179-03 49.00€

Jogo de 6 adaptadores para funil líquido refrigerante AE300180

Adaptadores para veículos Europeus.



AE300221

Adaptadores para funil líquido refrigerante AE300180

Ref.	Aplicação	Preço
AE300221-02	Veículos Japoneses	18.50€
AE300221-03	Honda, Toyota	26.30€
AE300221-04	Ford, Mazda, Mitsubishi, Nissan	19.20€



AI050192 43.10€

Funil universal para óleo

Grampo de fixação ajustável: 28-74mm



AI060006 10.20€

Reparador "rosca" alojamento de velas

Medida: 14mm



AI060020 4.60€

Apalpa folgas com 20 lâminas

Medidas (mm): 0,05; 0,10; 0,15; 0,20; 0,25; 0,30; 0,35; 0,40; 0,45; 0,50; 0,55; 0,60; 0,65; 0,70; 0,75; 0,80; 0,85; 0,90; 0,95 e 1



AI060030

229.10€

Kit de reparação de roscas de alojamento de velas com 56 peças

AI060030

Helicoides

Ref.	Medida	Quadra	Quantid.	Preço
AI060030-A	M10x1,0	3/8	10	8.70€
AI060030-B	M12x1,25	3/4	10	17.00€
AI060030-C	M14x1,25	7/16	10	20.00€

AI060030

Punção

Ref.	Medida	Quantid.	Preço
AI060030-D	M10x1,0	1	13.70€
AI060030-E	M12x1,25	1	17.30€
AI060030-F	M14x1,25	1	24.60€

AI060031

150.40€

Kit reparador de roscas com 87 peças

Composição:

Helicoides:

Medidas:

25x M6x1.0x1.5 (9mm)

25x M8x1.25x1.5 (12mm)

25x M10x1,5x1,5 (15mm)

Macho:

M6x1.0

M8x1.25

M10x1.5

Punção:

M6x1.0

M8x1.25

M10x1.5

Broca:

6,3mm

8,3mm

10,4mm

Punho:

M6x1.0

M8x1.25

M10x1.5

AI060031

Helicoides

Ref.	Medida	Quantid.	Preço
AI060031-A	M6x1,0	10	6.20€
AI060031-B	M8x1,25	10	7.60€
AI060031-C	M10x1,5	10	9.90€

AI060031

Punção

Ref.	Medida	Quantid.	Preço
AI060031-D	M6x1,0	1	8.20€
AI060031-E	M8x1,25	1	11.00€
AI060031-F	M10x1,5	1	14.50€

AI060031

Broca

Ref.	Medida (mm)	Quantid.	Preço
AI060031-G	6,6	1	5.30€
AI060031-H	8,3	1	9.90€
AI060031-J	10,4	1	14.90€

AL010006

38.60€

Jogo de 3 alicates

Para ligações rápidas de tubos de combustível

AL010011

27.60€

Chave para fêmeas suspensão

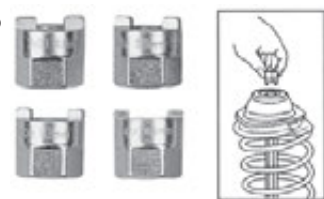

AL010073

200.40€

Kit para remoção das cabeças dos amortecedores

Aplicação: BMW, Fiat, Honda, Mercedes, Mitsubishi, Nissan, Opel, Peugeot, Renault, Suzuki, Toyota e Volvo

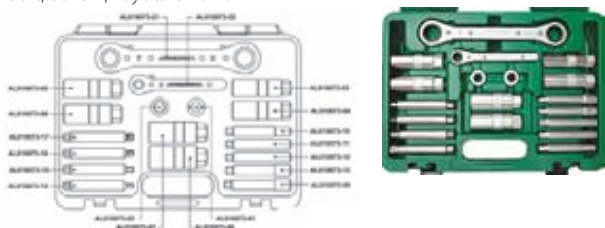

AN010001

60.90€

Kit de ferramenta para travões com 11 peças

Para recuar e rodar êmbolos dos travões



AN010001C

79.50€

Kit de ferramenta para travões com 18 peças

Para recuar e rodar êmbolos dos travões



AN010001D

200.60€

Kit de ferramenta para travões

Para recuar e rodar êmbolos dos travões



AN010001D

Adaptadores

Ref.	Marca	Preço
AN010001D-2	Citroën, Honda	7.60€
AN010001D-3	Vários	8.60€
AN010001D-4	Vários	5.60€
AN010001D-5	Adaptador 3/8"	7.40€
AN010001D-6	Nissan, VW	5.50€
AN010001D-7	Vários	5.50€
AN010001D-A	Renault	5.50€
AN010001D-E	Nissan, Ford	5.50€
AN010001D-F	Opel	5.50€
AN010001D-K	Citroën	8.80€
AN010001D-M	Vários	5.50€
AN010001D-N	Ford, Mazda, Mini	5.50€



AN010293

42.70€

Chave especial para pressionar as pinças de travão



AN010102

17.90€

Alicate para comprimir a mola do travão de mão



AN010321

28.70€

Alicate para cabo do travão de mão



AN010322

44.30€

Alicate para molas de travões do tambor



AN010033 6.90€

Removedor do interior de válvulas 

AN010085A 17.60€

Ferramenta para colocar válvulas de pneus 

AN010038 8.70€

Extrator de vedantes 

AN010049 15.50€

Centrador de embraiagens 

AN010063 80.90€

Alicate para freios de travão 

AN010065 79.70€

Jogo de 4 pinças para cilindros de travão 

AN010081A 28.00€

Alicate de molas de travões 

AN010160 22.40€

Ferramenta para verificação da altura dos calços de travão 

AR060011 14.00€

Dispositivo para bloquear tubos 

AN010066 54.80€

Kit de desmontagem de embraiagem do compressor A/C
Aplicável em várias marcas de compressores A/C



AN010054A 26.80€

Jogo de 3 alicates para oclusão de tubos 

AN010054N 29.90€

Alicate de pressão para tubos 

AR060062 43.60€

Alicate tensor para abraçadeiras de tubos
Amplitude: 5 a 55mm 

AN010068 8.30€

Limpa bornes e terminais de bateria 

AN010072 36.20€

Reparador de rosca interno e externo
Medidas das rosca: 0,8; 1; 1,25; 1,50; 1,75; 2 e 3mm



AN010072C 22.10€

Reparador de rosca SAE (polegadas)

Medidas das rosca: 9"; 10"; 16"; 20"; 27"; 28" e 32"



AN010091A 115.00€

Removedor da barra de direção

Estas ferramentas são especialmente projetadas para os tirantes internos que são inacessíveis para o ajuste. A chave longa pode ser facilmente usada com sete chaves de bocas, tamanho:

1-3/16"; 1-1/4"; 1-5/16"; 1-7/16" e 14mm; 17mm; 33,6mm

O tirante interno pode ser facilmente removido e instalado deslizando a chave longa sobre a extremidade do tirante e conectando-o à chave bocas.

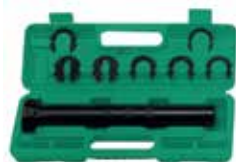

AN010092 85.60€

Chave excêntrica para direções/ barras

Medida: 33-42mm



AN040327 32.30€

Ferramenta de ajuste do eixo traseiro MB



AI030075 33.40€

Alicate para tubos de escape



AN010106A 58.90€

Corta tubos de escape

Não utilizável em tubos de aço inox

Medidas: 19 a 76mm de diâmetro



AN010106A-C 33.30€

Corrente de corte para corta tubos de escape



AN010112 24.40€

Adaptador para saca de semieixo



AN010131 21.80€

Rolete calcador



AN010137 97.00€

Alicate para cubos de rodas



AN010186B 719.70€

Kit para embraiagens auto ajustáveis



AN010188

Ferro desmonta pneus

Ref.	Medida (mm)	Preço
AN010188A	500	28.50€
AN010188B	350	13.10€
AN010188C	200	5.60€



AN010225 684.70€

Ferramenta para instalar/ remover rolamento manga eixo

Permite rapidez, segurança e profissionalismo sem esforço na tarefa

Aplicação: PEUGEOT, CITROËN e RENAULT



AN010226
21.70€
Medidor de espessura dos discos de travão e profundidade do piso dos pneus

 Discos de travão: 0-60mm
 Material: alumínio

AN010319
140.70€
Medidor digital da espessura dos discos de travão e profundidade da espessura pneus

Capacidade medição: 0-100mm

AN010320
92.00€
Medidor dos discos de travão

AG010205
23.90€
Medidor digital de profundidade

Utilizado para medir a profundidade do piso dos pneus e das pastilhas de travões.

Especificações:

Gama de medição: 0-25,4mm

Resolução: 0,01mm

Display: LCD

Medição em milímetros ou polegadas.

Utiliza pilhas SR44/ LR44 de 1,4V (não incluídas).

AN010272
19.50€
Alicate para tampas plásticas fêmea da roda

Permite retirar as tampas plásticas das fêmeas da roda sem danificar as jantes.

AN010279
419.90€
Mecanismo para desbloqueio de roda MB/ BMW

Aplicação

Mercedes Benz: W164 (Classe GL); W197 (SLS); W204 (Classe C); W212 (Classe E); W221 (Classe S) e W251 (CLR)

BMW: F01/F02 (Série 7); F07/F10 (Série 5);

F12/F13 (Série 6); F25 (x3) e

F30/ F31/ F32/ F33/ F34 (Séries 3 e 4)

AN020007
35.80€
Despolidor de cilindros

Medida: 51-177mm

AN020007-1
15.20€
Jogo de 3 pedras para despolidor de cilindros

Aplicável ao despolidor AN020007

AN020022
36.90€
Jogo de despolidor de cilindros

Composição/ medidas (mm):

Medida: 18-89

Pedras: 19; 28,8 e 51

Jogo de pedras de substituição

AN020022
Jogo de pedras para despolidor de cilindros

Ref.	Medida (mm)	Unidades	Preço
AN020022-A	51	3	10.30€
AN020022-B	28,8	2	7.40€
AN020022-C	19	3	6.90€
AN020022-D	28,8	2	6.60€

AN040035A
21.30€
Corta tubos

AN040043A
67.80€
Jogo de cortar tubos e abocardador

Composição/ medidas (mm):

Fixador de tubos: 4; 6; 8; 10; 12; 15 e 16

Punções abocardador: 4; 6; 8; 10 e 12

AN040101
9.30€
Bit 1/2" pentagonal para freios travões

AN040168

506.10€

Jogo de ferramenta para instalar/ remover rolamentos de roda
Permite rapidez, segurança e profissionalismo sem esforço na tarefa
Para rolamentos: 60 a 85mm



AR020018

28.90€

Teste de compressão

Tubo flexível com adaptador: 14 e 18mm
Escala: 0-300psi; 21kg/cm²; 21bar e 2 100kpa



AR020019

27.90€

Teste de vácuo e bomba combustível



AR020053A

272.10€

Kit de acessórios eletricitista/ eletrônica auto



AR030013

5.10€

Densímetro para líquido de baterias



AR030034

7.80€

Auto tester circuitos entre 3-48V
Indicação da polaridade por Leds



AR030041

88.10€

Jogo de 7 aplicadores de o-rings

Composição/ medidas (mm):
14,4-16; 15,9-17,5; 17,5-19,1; 20,7-22,4;
24-26; 25,5-27,5 e 30,3-32,3



AR030047

29.80€

Teste fluido de travões
Bateria não incluída.



AR030062

46.20€

Teste de atuadores

Este aparelho permite o teste a componentes eletrónicos que atuem por campos magnéticos e eletromagnéticos.



AR040043

21.10€

Saca terminais de cabo de bateria e limpa parabrisas



AR040016

96.60€

Jogo de cabos de arranque de bateria 500 Amp

Dimensões: 0.3x268x12mm
Comprimento: 3 600mm



AR060002A

31.50€

Alicate para abraçadeiras - matriz "+"



AR060003

20.40€

Alicate para abraçadeiras - matriz "V"



AR060008

21.20€

Alicate para abraçadeiras de filtros de combustível e tubos de vácuo



AR060009

23.20€

Alicate de aperto para abraçadeira de baixo perfil



AR060038

23.90€

Alicate angular para abraçadeiras tubos



AR060039A

23.30€

Alicate para abraçadeiras tubos



AR060055

30.70€

Alicate de abraçadeiras de tubos
Abertura de 22 a 55mm



AR060056

34.70€

Alicate abraçadeiras tubos
Medida: 0-38mm



AR060010

27.80€

Alicate para tubos do radiador



AR060020

17.30€

Alicate para remover tubos



AR060021

58.90€

Alicate para abraçadeiras



AR060024A

229.80€

Kit de 7 alicates para abraçadeiras



AN010177B

69.10€

Alicate especial para abraçadeiras de fole



AR060029A

89.00€

Alargador de foles



AR060032

20.90€

Kit de adaptadores para desencaixe de tubos A/C



AR060043

138.50€

Jogo de 52 peças para remoção de rádios

Aplicação:
Marca Auto: AUDI; BMW; FIAT; FORD; SKODA;
MERCEDES; OPEL; PORSCHE e VOLKSWAGEN
Marca Rádio: Becker; Blaupunkt; Clarion; JVC;
Grundig; Kenwood; Panasonic; Pioneer e Sony



Ferramenta - aplicação especial por MARCAS GRUPO BMW e MINI

AI010121

80.90€

Chave para boia do depósito de combustível

Aplicação: AUDI, BMW, MERCEDES, PORSCHE e VOLKSWAGEN

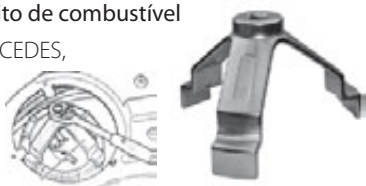

AI010139

140.40€

Ferramenta para desmontagem do sensor do nível de combustível

Aplicação: BMW e MINI

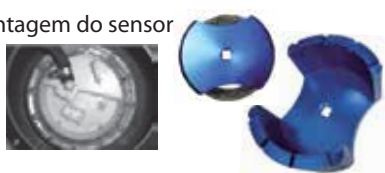

AI020184A

17.30€

Chave para injetores BMW e Volkswagen

Quadra: 1/2"

Medida: 14mm

Comprimento: 119mm



AI050071S

399.40€

Jogo de 8 chaves especiais BMW



AL010099

358.40€

Kit comando de motor diesel BMW

Modelo	Motorização
E34/ E36/ E38/ E39/ E46/	M41/ M51/ M47TU/ M47T2/
E53/ E60/ E61/ E63/ E65/	M57TU/ M57T2
E66/ E70/ E83/ E87/ E90/ E91/	
Land Rover	2.5DT/ 3.0TD6/
Freelander	2.0TD4



AI010115

35.40€

Saca bombas injetoras BMW

Modelo	Motorização
318D/ 320D/TD/ 330D	E46
525D/ 530D	E39
525D/ 530D/ 535D	E60/E61
730D	E38
X5 3,0D	E53



AL010128

70.90€

Kit comando de motor BMW

Modelo	Motorização	Ano
118d	E87	2003-2007
120d	E87	2003-2007
318d/td	E46 E90/91	2000-2008
320d/crd	E46 E90/91	1997-2008
325d	E90/91/92/93	2006-2010
330d/xd/crd	E46 E90/91/92/93	1998-2008
510d	E39 E60/61	1999-2010
525d/xd	E39 E60/61	1999-2010
530d/xd	E39 E60/61	1998-2010
535d	E60/61	2004-2010
635d	E63/64	2004-2010
730d	E38 E65/66	2003-2010
X3 2,0d	E83	2003-2007
X3 3,0d	E83	2003-2010
X5		



**Ferramenta - aplicação especial por MARCAS
FIAT e OPEL**

AL010044

178.50€

Kit comando de motor FIAT/ OPEL

Marca	Modelo	Motorização	Ano	Peças nº
FIAT	Panda/ Idea/ Doblo	1.3JTD MultiJet 1.7D/ 1.9D/ TD/ JTD2.4 1.9/ 2.4JTD 16V/ 20V	2004-2007	7; 8; 9; 10 1; 3; 4 2; 3; 4; 5; 6; 7
OPEL	Agila/ Corsa/ Astra H/ Tigra B/ Meriva/ Astra/ Vectra/ Signum/ Zafira	1.3CDTI 1.9CDTI	2004-2007 2004-2006	7; 8; 9; 10 2; 3; 4; 5; 6; 7
ALFA ROMEO	147/ 156	1.9JTD 16V/ 2.4JTD 20V		2; 3; 4; 5; 6; 7



AL010196

65.50€

Kit comando de motor gasolina

Marca	Modelo	Motorização
ALFA ROMEO	159	939A4.000
CHEVROLET	Aveo/ Cruze/ Orlando	
FIAT	Croma	939A4.000
OPEL	Astra G/ Astra H/ Corsa D/ Meriva A/ Zafira B/C/ Vectra C/ Signum/ Insignia	Z16LEL/ Z16LER/ Z16LET/ Z16ZE1/ Z16XEP/ Z16ZER/ LLu/ A16LET/ A16XEL/ 2HO/A18XEL/ 2HO/A18XE R/Z18XER

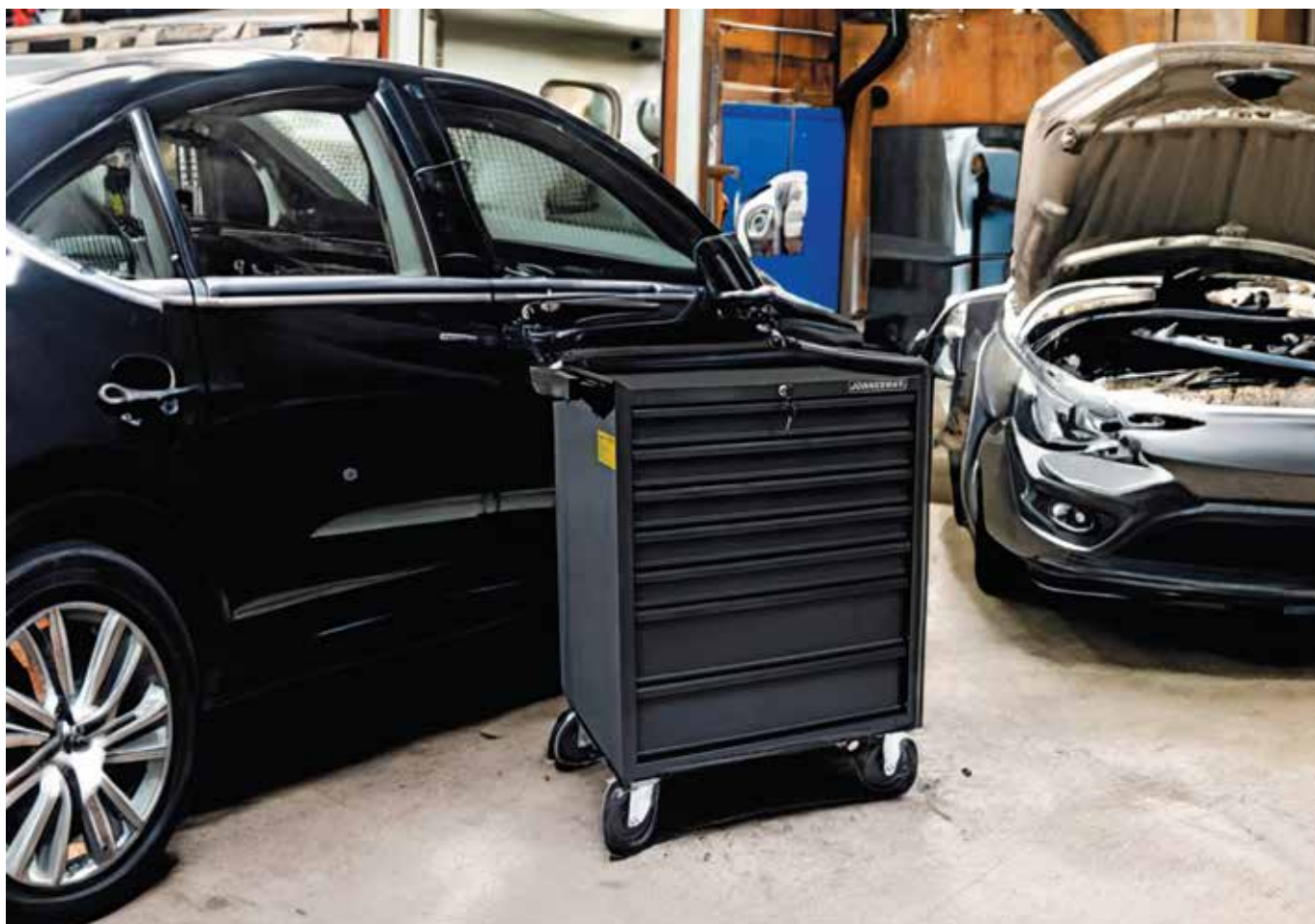

**Ferramenta - aplicação especial por MARCAS
FORD, MAZDA e VOLVO**

AL010070

30.90€

Kit comando motor FORD/ PEUGEOT/ CITROËN

Marca	Modelo	Motorização:
FORD	Fiesta/ Fusion	1.4TDCI
	Focus/ Focus C-Max	1.6TDCI
	Fusion/ Fiesta	1.6TDCI
CITROËN	C4	1.6HDI
PEUGEOT	206	1.4HDI
PEUGEOT	307	HDI



AL010071

100.50€

Kit comando motor FORD

Modelo	Motorização	Ano
Fiesta	1.8D Turbo	
Focus		
Focus C-Max	1.8TDCI	
Tourneo Connect	1.8TDDI/ TDCI	
Transit Connect	1.8TDDI/ TDCI	2002-2006



AI010107

95.20€

Kit comando motor FORD

Modelo	Motorização em diesel
Fiesta	1.8TDDI/ TDCI
Focus	Turbo
Transit	
Transit Connect	



AL010175

40.70€

Pino de fixação árvore de cames

Marca	Modelo	Motorização	Ano
FORD	Fiesta/ Fusion	1.4TDCI	2002>2009
	Focus C-Max	1.4/ 1.6TDCI	
	Mondeo	2.0TDI/ TDCI/ 2.2TDCI	
	Transit	2.0TDI/ TDCI/ 2.4TDI/ TDCI	
	VOLVO	S40/ V50	1.6D/ 1.9D



AL010205

11.00€

Kit comando motor FORD/ MAZDA/ VOLVO

Marca	Modelo	Motorização
FORD	C-Max/ Cougar/ Fiesta/ Focus	HWDA/ HWDB/ CSDA/ QQDA/ QQDB/ QQDC/ AODA/ AODB/ DBA/C/ EDBB/ EDBD/ F8JA/ F8JB/ FUJA/ FUJB/ M7JA/ M7JB/ FXJA/ FX JB/ FYJA/ FYJB/ N4JB/ FHA/ FHE/ L1T/ L1V/ ASDA/ ASDB/ FXDA/C/ FXDB/D/ FYDA/C/ FYDB/D/ EYDB
	MAZDA	6
VOLVO	C-30/ S40/ S80/ V50/ V70	B4164S3/ B4184S11/ B4204S3



AL010218

180.70€

Kit comando motor FORD

Modelo:

Fiesta/ Fusion/ Focus/ C-Max/ B-Max/ S-Max/ Mondeo/ Galaxy



AN040286

402.80€

Extrator de sinblocos

Marca	Modelo	Ano
FORD	Focus I	1998-2005
	Focus II	2004-2008
	CB4	2008-2011
MAZDA	3	2003-2008
	3	2009->
	5	2005-2010



Ferramenta - aplicação especial por MARCAS HYUNDAI e KIA

AL010282
82.20€
Kit comando motor HYUNDAI/ KIA
Aplicação:

HYUNDAI: Accent; Elantra; Getz; i10; i20; i30; i40; ix35; ix55; Matrix e Tucson.

KIA: Carens; Cee'd; Cerato; Optima; Picanto; Pro-Cee'd; Rio; Soul; Sportage e Venga.



Ferramenta - aplicação especial por MARCAS MERCEDES

AG010204
11.90€
Chave de impacto para rodas especial - MERCEDES 1/2" com 17mm
Aplicação:

MERCEDES: W204 (Classe C); W204(GLK); W207/ W211/ W212 (Classe E); W166 (Classe M); W221/ W222 (Classe S); W172 (SLK); W164/ W166 (ML) e W216 (CL) e Maybach.

AI010114
45.60€
Jogo de ferramentas para airbag

AI010097
22.40€
Chave hexagonal 1/2" especial para SCANIA e MERCEDES

Comprimento: 27mm

AI010116
57.20€
Saca velas de incandescência

Motorização: 611/ 612/ 613

Comprimento: 10mm

AI020113
185.90€
Jogo saca injetores common rail MB
Motorização:

OM 611/ OM 612/ OM 613

AI020184
17.80€
Chave para injetores MERCEDES BENZ

Quadra: 1/2"

Medida: 17mm

Comprimento: 119mm

AI020184B
19.00€
Chave para injetores MERCEDES BENZ

Quadra: 1/2"

Medida: 19mm

Comprimento: 119mm

AI020186
70.30€
Jogo saca bicos injetores
Modelo
Motorização

Classe C/ Classe E/

108CDI/ 110CDI 16V/ 112CDI 16V/

Sprinter

C220CDI 16V/ E200CDI 16V

AI050071S
399.40€
Jogo de 8 chaves especiais MB

AI050085A
20.90€
Chave de filtros de 14 faces com 74mm

Nota: Se usar com uma chave caixa de 27mm, deve ser aplicada uma força máxima de 25Nm, caso sejam aplicadas forças superiores, corre-se o risco de danificar a chave filtros.

Marca:

MERCEDES/AUDI A3/ BMW E36/ CITROËN/ FIAT/ FORD/ LANCIA/ MAZDA/ NISSAN/ OPEL/ PEUGEOT/ PORSCHE/ RENAULT/ TOYOTA/ VOLKSWAGEN Golf IV



AI050200

102.00€

Jogo de 4 varetas para óleo de transmissão

Aplicacion: Mercedes Benz



AL010057

170.30€

Chave bloqueadora de cambotas MB



AN040126

259.00€

Extrator de sinoblocos eixo traseiro MB



Ferramenta - aplicação especial por MARCAS GRUPO PSA - PEUGEOT/ CITROËN

AI010136

128.90€

Kit comando motor HPI (gasolina) e HDI (diesel) PEUGEOT/ CITROËN

Marca	Modelo	Motorização	Ano
PEUGEOT	206/ 307/ 406	1.8 16V	2000-2004
	607/ 806/ 807	2.0 16V	2002-2005
	Expert		
CITROËN	C4/ C5	1.8/ 2.0HPI	2002-2005
	Xsara	2.0 16V	2002-2005
	Xsara Picasso	1.8/ 2.0 16V	2002-2005
	Evasion/ C8 Jump		

Códigos motor: 6FZ (EW7J4)/ FRN (EW10J4/L4/5)/ RLZ (EW10D)



AL010175

40.70€

Pino de fixação árvore de cames

Marca	Modelo	Motorização
CITROËN	C1/ C2/ C3/ Xsara	1.4HDI
	C3/ C4	1.6HDI
PEUGEOT	107/ 206/ 207	HDI
	307	1.4/ 1.6HDI



AN040100

9.90€

Chave de caixa pentagonal para travões PSA

Medida: 17mm



AL010041

203.70€

Kit comando motor HPI (gasolina) e HDI (diesel) PEUGEOT/ CITROËN

Marca	Modelo	Motorização	Ano	
CITROËN Diesel	Visa/ BX/ ZX/ Xantia/ Xsara/ Synergie/ C15/ Berlingo/ Dispatch/ C25/ Relay	1.7/ 1.8/ 1.9/ D/ TD	1984-2002	
	Saxo/ AX/ Xsara	1.5D	1994-2007	
	Xsara/ Berlingo/ Dispatch	1.9D	1998-2007	
	Xsara/ Xsara Picasso/ Xantia/ C5/ Synergie/ Berlingo/ Dispatch/ Relay	2.0HDI	1998-2007	
	C4	2.0HDI	2004-2008	
	C5	2.2HDI	2000-2004	
	C8	2.0/ 2.2/ HDI	2002-2007	
	Relay	2.5D/ TurboD	1994-2002	
	XM/ Xantia/ Dispatch/ Synergie/ Evasion	2.1D/ 2.2D/ TD	1994-2002	
	CITROËN Gasolina	AX/ Xsara/ AX GTI/ Saxo/ ZX/ Berlingo	1.0/ 1.1/ 1.4/ 1.6	1994-2004
		C2/ C3/ C3 Pluriel/ Berlingo	1.0/ 1.1/ 1.4	2002-2007
		Saxo/ Xsara	1.6 16V	1997-2006
		C2/ C3 Pluriel/ C4	1.6	1997-2006
		Xsara/ Xantia	1.8 16V	2002-2008
ZX/ Xsara		2.0 16V	1996-2000	
Synergie/ Evasion/ Relay/ Jumper		2.0 Turbo	1994-2002	
Xsara		2.0 16V	2000-2004	
Xsara/ C5/ Xsara Picasso		2.0HPI/ 2.0 16V/ 1.8	1999-2002	
Xsara/ C5/ Xsara Picasso		2.0HPI/ 2.0 16V/ 1.8	2002-2008	
PEUGEOT Diesel		205/ 305/ 405/ Partner/ 306/ 309 Talbot Horizon/ Solara Express	1.8/ 1.9/ D/ TD	1982-2001
		206/ 307	1.4 HDi	2001-2008
		206/ 306/ Express/ Partner	1.9D	1998-2007
		206/ 306/ 307/ 406/ 806/ 807	2.0HDI/ 2.0HDI 16V	1997-2007
	307/ 307 CC/ 407	2.0HDI	2003-2008	
	406/ 607	2.2HDI	2002-2007	
	406/ 806/ Expert/ Boxer	1.9D/ TD	1994-2002	
	406/ 605/ 806	2.1D Turbo	1994-2002	
	PEUGEOT Gasolina	106/ 205/ 306/ 307/ 405/ Partner	1.0/ 1.1/ 1.4/ 1.6	1993-2008
		206	1.1/ 1.4/ 1.6	1998-2008
		205/ 309/ 306/ 405/ 806/ 605/ 406/ Partner/ Boxer	1.6/ 1.9/ 1.8/ 2.0	1989-2002
		206/ 307	1.6 16V	2000-2008
		306/ 407	1.8 16V	1999-2002
		206/ 307/ 406/ 406 Coupe/ 607/ 806	2.0 16V	1998-2000
306/ 406		1.8 16V	1995-1998	
306/ 406		2.0 16V	1994-2001	
306/ 406		1.6/ 2.0 Turbo	1994-2001	
406		1.8 16V	2000-2004	
406/ 406 Coupe/ 607		2.2 16V	1998-2008	
807		2.0 16V	2002-2005	



RENAULT, NISSAN e DACIA

AL010038
23.80€
Kit comando de motor RENAULT/ NISSAN

Marca	Modelo	Motorização
RENAULT	Modus/ Laguna/ Kangoo/ Clio	1.5dCI/ 1.9dCI
NISSAN	Almera/ Micra	1.5dCI

AL010190
71.30€
Kit comando de motor

Marca	Modelo	Motorização	Ano
RENAULT	Clio	1.2/ 1.4/ 1.6	
	Clio Sport	2.0	
	Espace	2.0	
	Scenic	1.4/ 1.6/ 1.8/ 2.0	
	Scenic II	1.4/ 1.6/ 2.0	
	Grand Scenic II	1.4/ 1.6	
	Laguna	1.8/ 2.0	
	Laguna II	2.0	
	Megane	1.4/ 1.6/ 1.8/ 2.0	
	Megane II	1.4/ 1.6/ 2.0	
DACIA	Logan	1.4/ 1.6	
	Sandero	1.4/ 1.6	
NISSAN	Micra		2003>2008
	Almera		2002>2006
	Note		2006>2008
	Qashqai		2007>2008
Diesel		1.2/ 1.4/ 1.6/ 1.8 (8v-16v)/ 2.0IDE/ 2.0Turbo	

Códigos motor: D4F/ K4J/ K4M/ K7M/ K9K/ F4P/ F3R/ F4R/ F5R/ F4RT



Ferramenta - aplicação especial por MARCAS GRUPO VAS - AUDI, VOLKSWAGEN, SKODA, SEAT e PORSCHE

AI010069
28.60€
Ferramenta de bloqueio da cambota VOLKSWAGEN

Para bloquear a cambota quando se quiser substituir a correia ou outros componentes.

Marca	Modelo	Motorização
AUDI	A4/ A6	
SEAT	Alhambra/ Altea/ Arosa/ Cordoba/ Ibiza/ Leon/ Toledo	
VOLKSWAGEN	Bora/ Golf/ Lupo/ Passat/ Polo	TDI's

AI010070
36.00€
Ferramenta de bloqueio da cambota (VAS)

Marca	Modelo	Motorização	
AUDI	A2	1.4TDI	
	A3	1.9TDI/ 2.0TDI	
	A4	1.6TDI/ 1.9TDI/ 2.0TDI	
	A6	1.9TDI	
	SEAT	Altea	1.9SDI/ TDI
		Leon	1.9/ 2.0TDI
Toledo		1.9SDI/ TDI	
VOLKSWAGEN	Beetle/ Bora/ Sharan	1.9TDI	
	Fox/ Lupo	1.4TDI	
	Golf	1.9/ 2.0TDI	
	Polo	1.4/ 1.9TDI	

AI020127
53.50€
Ferramenta para tirar injetores

Aplicação: Grupo VAS (motores TDI)

AI020154
337.10€
Instalador vedante da cambota VOLKSWAGEN

Marca	Modelo	Ano
AUDI	A3	2004>
	A4	
SKODA	Octavia2/ Roomster/ Fabia	
VOLKSWAGEN	Golf	2004>
	Transporter T5/ Caddy/ Touran	2004>



AI020184A 17.30€

Chave para injetores BMW e VOLKSWAGEN

Quadra: 1/2"
Medida: 14mm
Comprimento: 119mm



AI050079 14.70€

Chave bujão caixa de velocidades e transmissões 1/2"

Marcas: AUDI e VOLKSWAGEN
Chave estriada XZN Tamperproof M16



AI050201 42.30€

Varetas para óleo

Aplicação: Audi/Volkswagen



AL010029 37.50€

Ferramenta de alinhamento dupla árvore cames motores gasolina

Marca	Modelo	Motorização
AUDI	A2	1.4/ 1.6
SEAT	Arosa/ Ibiza/ Cordoba/ Toledo/ Leon/ Inca	1.4/ 1.6
SKODA	Fabia/ Octavia	1.4/ 1.6
VOLKSWAGEN	Lupo/ Polo/ Golf/ Bora/ Beetle/ Caddy	1.4/ 1.6



AL010053A 71.20€

Kit comando do motor

Marca	Modelo	Motorização	Ano
VOLKSWAGEN	Polo	1.2 6V/ 12V	2002>
SEAT	Ibiza	1.2 6V	2002>
SKODA	Fábia	1.2 6V/ 12V	2003>



AL010072 9.90€

Kit comando do motor

Marca	Modelo
AUDI	A4/ S3/ A6/ TT
SEAT	Ibiza/ Cordoba/ Leon/ Toledo/ Alhambra
SKODA	Octavia
VOLKSWAGEN	Golf/ Bora/ Beetle/ Passat



AL010081 422.30€

Kit comando motor BMW



AL010087 227.90€

Kit comando de motor AUDI

Marca	Modelo	Motorização
AUDI	A4	3.2FSI
	A6	2.4
	A6	2.4quattro
	A6	3.2FSI A)
	A8	3.2FSI A



AL010088 94.10€

Kit comando de motor a gasolina

Marca	Modelo	Motorização
AUDI	A3	1.4L/ 1.6 FSI
SKODA	Octavia	
VOLKSWAGEN	Polo/ Golf/ Golf Plus/ Jetta/ Passat/ Touran	



AN010202 33.40€

Chave de impacto especial XZN 3/4" para cubos rodas AUDI/ VOLKSWAGEN

Medida: M18
Comprimento: 105mm



AN010202B 16.00€

Chave de impacto XZN 1/2" AUDI/ VOLKSWAGEN

Especialmente concebida para o aperto dos parafusos que fixam o eixo traseiro

Medida: M18
Comprimento: 78mm



AI010108 28.50€

Ajustador do rolete tensionador

Marca	Modelo
AUDI	A4/ A6/ Cabrio
SEAT	Ibiza
SKODA	Superb
VOLKSWAGEN	Polo/ EOS/ Passat

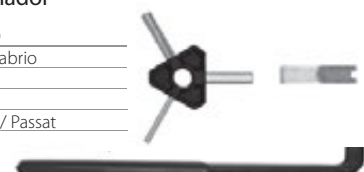

AL010291
137.20€
Kit comando motores VAS

AL010110
253.20€
Jogo sincronismo motor - grupo VAS

Marca	Modelo	Motorização	Ano
AUDI	A3	1.6FSI	2003-2006
	A3/ S3	1.8Turbo	1996-2003
	A4/ A6	1.8Turbo	1994-2006
	Cabriolet		1997-2000
SEAT	TT	1.8Turbo	1998-2006
	Ibiza	1.8Turbo	1999-2002
	Cordoba	1.8Turbo	
SKODA	Leon	1.8Turbo	1999-2005
	Toledo	1.8Turbo	1999-2005
	Octavia	1.8Turbo	1996-2005
VOLKSWAGEN	Octavia	1.8Turbo	2000-2005
	20V RS		
	Golf	1.6FSI	
	Touran	1.6FSI	
	Beetle	1.8Turbo	1999-2006
	Golf/ Bora	1.8Turbo	1997-2005

AL010202
7.70€
Pino fixação cambota - grupo VAS

Esta chave é equivalente à ferramenta especial VAG T10340

Marca	Modelo	Motorização
VOLKSWAGEN	Polo/ Golf/ Golf VI	1.4/1.6TSI/FSI
	Cabrio/ Golf Plus/	
	Golf Variant/ Touran/ EOS/	
	Passat/ Jetta/ Scirocco/	
	Beetle/ Sharan/ Tiguan/	
	Caddy/ Caddy Maxi/ Fox	
AUDI	A3	1.4/1.6TSI/FSI
SEAT	Cordoba/ Ibiza	1.4/1.6TSI/FSI
SKODA	Fabia/ Roomster	1.4/1.6TSI/FSI



Códigos de motor: AWY/ AXU/ AZQ/ BAG/ BBM/ BKG/ BLF/ BLG/ BLN/ BLP/ BMD/ BME/ BMY/ BTS/ BWK/ BZG/ CAVA/ CAVB/ CAVC/ CAVD/ CAXA/ CEVA/ CGPA/ CGPB/ CHFA

AL010203
7.60€
Pino de fixação da cambota - grupo VAS

Esta chave é equivalente à ferramenta especial VAG T40069

Marca	Motorização
AUDI/ SEAT/ SKODA/ VOLKSWAGEN	2.0/ 2.4/ 3.2FSI/ 3.0V6 TDI/ 4.2 V8 TDI/ 2.8/ 1.4/ 1.6 TSI/FSI

Código de motor: BGP/ BGQ/ CBUA/ CBTA/ BPR/ BPS



AL010225
92.80€
Kit comando motores VOLKSWAGEN

Modelo	Motorização	Ano
Transporter	2.4D T4	1995>2003
Código de motor: AAB/ AJA		
Transporter	2.5TDI	1995>2003
Código de motor: ACV/ AHY/ AJT/ AUF/ AXG/ AXL/ AYC		
Crafter	2.5TDI	2006 >2012
Código de motor: BJJ/ BJK/ BJL/ BJM		

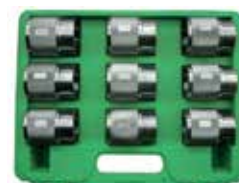

ME010001
509.30€
Jogo de guias para montagem de retentores suspensão

Composição:

Ref.	Compr. (mm)
329-01	449/50
329-02	45
329-03	43
329-04	41
329-05	39
329-06	35/36
329-07	48
329-08	54
329-09	46/47

ME010007
40.40€
Chave de montagem/ desmontagem da forqueta invertida

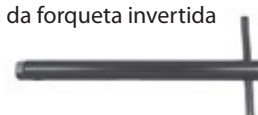
Marca: Kayaba/ Showa

ME010009
13.10€
Saca pip de válvula de ar

ME010010
23.70€
Jogo de guias para casquilhos suspensão

 Composição/ medidas (mm):
12,5; 14; 16 e 18

ME010012
38.00€
Guia para montagem/ desmontagem forqueta invertida

ME020001

46.40€

Removedor do rolamento da coluna da direção
Abertura: 30-68mm



ME020002

72.50€

Ferramenta para instalação rolamento da direção
Diâmetro da haste: 26, 30, 31 e 35mm



ME020003

356.70€

Saca do rolamento da haste da mesa da direção
Medidas (mm): 44, 48 e 51mm



ME020005

100.30€

Guia para instalação do rolamento da direção
Diâmetro da haste: 26, 30, 31 e 35mm



ME020006

283.10€

Dispositivo de instalação das caixas dos rolamentos cônicos na coluna de direção

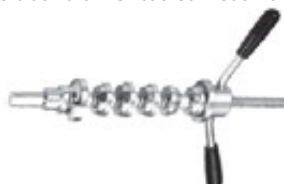
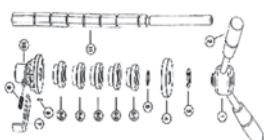

MG010001

50.00€

Saca cubo embraiagem/ polie alternador



MG01000

Chave fêmea da embraiagem



Ref.	Medida (mm)	Pinos	Preço
MG010002	34x59	2	22.80€
MG010003	41x59	2	23.10€
MG010004	39x72	2	26.20€
MG010005	46x72	2	26.20€
MG010006	46	3	26.30€

MG010008

35.70€

Ferramenta para comprimir embraiagem
Para motores 50 a 250cc
com polie de \varnothing 125 a 155mm



MG010009

44.10€

Ferramenta para comprimir embraiagem
Para motores 50 a 250cc
com polie de \varnothing 125 a 155mm



MG020001

43.20€

Corta corrente

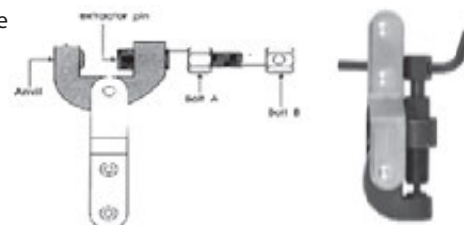

MG020003

89.60€

Corta/ rebitador da corrente



MG020006

19.10€

Ferramenta de fecho da corrente (transmissão ou distribuição)



MG020007

63.20€

Kit limpeza da corrente



MG020008

16.30€

Escova limpa correntes



MI010014

26.20€

Saca válvulas do motor



MI010016

53.10€

Removedor/ instalador do pino do piston

Medidas (mm):

Pistões: 40 a 100

Pinos: 12 a 25



MI010017

27.60€

Instalador dos segmentos do pistão



MI010018

31.40€

Protetor em alumínio para torno

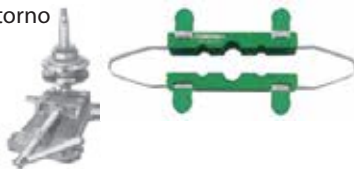

MI010019

222.50€

Ferramenta de auxílio para fecho do motor



MI010020

30.70€

Ferramenta de bloqueio embraiagem/ volante scooter



MI010021

26.20€

Saca para volante magnético



Motociclos

MI020001

14.10€

Chaves para jets 6 e 8mm



MI020002

25.00€

Jogo de chaves para carburadores FCR



MI020004

29.60€

Medidor do nível da altura da bóia do carburador



MN020004

8.90€

Protetor de jantes



MN020005

5.80€

Descolador de pneus



MT010001

10.10€

Oleador de cabos



MT010002

52.60€

Ferramenta de furação da fêmea e parafuso de segurança



MT010003

233.00€

Cavalete para roda traseira



MT010004

226.60€

Suporte central universal



MT010005

27.40€

Chave ajustável bloqueio de embraiagem



MT010006

30.30€

Chave ajustável bloqueio de embraiagem



MT010007

43.10€

EZ-ROLL (sistema rotação roda traseira)



MT010008

10.10€

Gancho para molas



CHAPEIRO

AB010001

57.10€

Kit de 10 peças para montagem de vidros



AB010002

102.30€

Kit de remoção para vidros parabrisas



AB010002-A

19.80€

Bobine de arame para remoção de vidros

Rolo de 20 metros arame liso de formato triangular.



AB010017

23.80€

Faca parabrisas



AB0100

Lâmina em aço para faca parabrisas

Ref.	Medida	Preço
AB010018	3/4"	2.30€
AB010019	1"	2.30€
AB010020	1-1/2"	2.30€



AB010026S

42.10€

Removedor de frisos e plásticos



AB010041 48.00€

Jogo de 12 chaves para remoção de painéis



AB010043 67.80€

Espelho auxiliar para reparação de mossas



AB020002 25.00€

Ventosa simples para vidros



AB020003A 55.70€

Ventosa dupla para vidros



AB020009 55.90€

Ventosa dupla articulada para vidros

Estrutura em alumínio
Ventosas: ø115mm



AB020010 76.10€

Ventosa tripla para vidros

Estrutura em alumínio
Ventosas: ø123mm
Capacidade: 35 kg/100 kg



AB020015 9.20€

Jogo de ventosas para colocar vidros



Chapeiro

AB020019 47.70€

Jogo de 6 ventosas

Para auxílio durante a colagem de frisos, vidros, etc



AB030001 7.90€

Jogo de 4 espátulas de 25 a 100mm



AB030014 12.60€

Ferramenta para colocação borrachas nos vidros



AB030028 5.30€

Chave para cavilhas e encaixes plásticos



AB030041 6.00€

Chave para cavilhas e encaixes plásticos



AB030043 5.80€

Chave para cavilhas e encaixes plásticos

Encaixe em "V"



AB030046 5.70€

Chave para cavilhas e encaixes plásticos

Encaixe de 8mm



AB030047 4.20€

Chave para cavilhas e encaixes plásticos

Encaixe de 6mm



AB030048 7.90€

Chave para cavilhas e encaixes plásticos



AB030049 11.40€

Chave para cavilhas e encaixes plásticos



AB030076

Molas de plástico

Ref.	Quant. Embl.	Preço
AB030076-01	300	23.20€
AB030076-02	300	24.10€
AB030076-03	200	23.30€
AB030076-05	150	20.30€
AB030076-06	150	20.20€
AB030076-07	200	23.10€
AB030076-11	200	24.80€
AB030076-13	200	21.70€
AB030076-14	100	23.30€
AB030076-15	100	25.00€
AB030076-17	100	24.80€
AB030076-18	200	23.20€
AB030076-20	200	23.80€
AB030076-21	100	27.40€
AB030076-24	100	27.20€
AB030076-26	100	28.00€
AB030076-27	100	29.20€
AB030076-28	100	29.20€
AB030076-30	100	25.00€
AB030076-32	100	23.80€
AB030076-34	200	42.90€



AB030076-00 105.90€

Jogo de 21 tipos de molas com 20 peças de cada
Caixa plástica



AB030060 56.20€

Jogo de 2 alicates para molas plásticas



AB030068A 36.90€

Alavanca de chapeiro

Medida: 380mm



AB030068C 46.10€

Alavanca de chapeiro

Medida: 900mm



AB030068D 42.90€

Alavanca de chapeiro

Medida: 750mm



AB030068F 29.20€

Alavanca de chapeiro

Medida: 450mm



AB030069A 31.00€

Cunha de chapeiro

Medida: 125mm



AB030069B 41.10€

Cunha de chapeiro

Medida: 137mm



AB030069E 10.40€

Cunha de chapeiro

Medida: 48mm



AB030094J 11.10€

Cunha de chapeiro

Medida: 84,7mm



AB030070B 29.20€

Encontrador de dupla face



AB030070C 26.00€

Encontrador curvo



AB030070D 38.60€

Encontrador tipo vírgula



AB030089

162.40€

Jogo de 7 encontradores para alumínio em polietileno de alta densidade



AB030100

73.80€

Martelo para alumínio com acessórios



AB030105

74.60€

Tira mossas com almofadas autocolantes



AB030071

46.50€

Martelo de cabeça redonda serrilhada



M10110

29.10€

Martelo de cabeça plana redonda e pena pontiaguda



M10210A

24.40€

Martelo de cabeça plana redonda e pena curva



M10210B

22.80€

Martelo de cabeça plana redonda e pena direita



Chapeiro

M10410A

30.80€

Martelo de puxar com cabeça redonda plana e quadrada rendilhada picotada



M10410B

32.40€

Martelo de puxar com cabeça redonda plana e quadrada rendilhada normal



AG010024

38.10€

Armação flexível para lima de chapeiro

Para limas de 355mm



AG010024

Lima para AG010024

Ref.	Serra	Compr.	Preço
AG010024-1	9	14"/355mm	36.80€
AG010024-2	12	14"/355mm	43.40€

AG010030A

187.60€

Jogo de martelos e encontradores



AG010185

120.30€

Alicate de rebordar



AG010055

30.30€

Desandador de percussão com acessórios



AG010055-B

3.80€

Jogo de 4 bits para AG010055/AG010138

Composição:

Fenda: 8 e 10mm
Philips: PH2 e PH3



AE310003

117.60€

Jogo de tira mossas



AE310004

294.20€

Jogo extractores



AE330004

76.00€

Pinça de chapeiro uni-direcional

Capacidade: 3t



AE330005

92.00€

Pinça de chapeiro bi-direcional

Capacidade: 2t (transversalmente)
3t (longitudinalmente)



AE330008

72.60€

Pinça de chapeiro bi-direcional

Capacidade: 2t (puxar cruzado)
3t (puxar direito)



AE330009

155.30€

Pinça de chapeiro tipo alicate uni-direcional

Capacidade: 3t



AE330013

156.60€

Pinça de chapeiro bi-direcional

Capacidade: 3t (transversalmente)
5t (longitudinalmente)



AE330015

277.40€

Pinça de chapeiro bi-direcional de 2 pontos

Capacidade: 5t



AE330016

55.30€

Gancho para união de corrente

Capacidade: 6t



AE330030

104.60€

Ponto fixo de puxar

Capacidade: 5t



AE330034

230.10€

Pinça de chapeiro de posição variável até 90°

Capacidade: 5t



AE330035

109.30€

Pinça de chapeiro

Capacidade: 5t



AG010138

27.60€

Desandador de percussão com 13 bits de 36mm

Phillips: PH1; PH2; PH3 e PH4
Fenda: 5; 6; 8; 10 e 12mm
Hexagonais: 4; 5; 6 e 8mm



AG010138-B

10.30€

Jogo de 13 bits para AG010138/AG010055



Chapeiro

AG010140

Encontrador múltiplo



14.60€

AG010141

Punho para chapeiro com pontas intermutáveis



79.10€

AG010142

Martelo para chapeiro com pontas intermutáveis



71.40€

AG010143

Punho com punções e escopros intermutáveis



77.20€

PESADOS

AL010113

Chave de 1/2" para rodar cambota

Aplicação: SCANIA



42.60€

AL010114

Chave de 1/2" para alinhar cambota

Aplicação:

Marca Motorização

MERCEDES 6.8/ 10 cilindros

MAN 12 cilindros



54.80€

AL010116

Chave de 11 dentes para alinhar cambota

Medida: Parafuso hexagonal de 24mm

Aplicação: DAF CF65/ CF75/ CF85/
F65/ F75/ F85/ F95/ XF95



70.70€

AL010117

Chave de 1/2" para alinhar cambota

Aplicação: DAF XF105 euro



39.20€

AN010187

Alicate para cintas de travões

Aplicação: VOLVO



176.70€

AI010153

Chave sensor de posição com 8 faces de 1/2"

Não utilizar com máquinas pneumáticas

Medida: 27mm

Comprimento: 60mm

Aplicação: MERCEDES Actros/ série SK/ MAN/ SCANIA



23.20€

AI020164

Chave para válvula eletromagnética com 8 faces de 3/4"

Medida: 38mm

Comprimento: 100mm

Aplicação: SCANIA



35.10€

AI040245

Chave para rolamentos da cambota de 3/4"

Medida: E28 - Torx

Comprimento: 90mm

Aplicação: SCANIA



33.20€

AI050135 152.00€

Jogo de chaves de copo para filtros - pesados

Composição:

- Chave 6 faces 36mm
- Chave 15 faces 74mm
- Chave 15 faces 106mm
- Chave 15 faces 107mm
- Chave 18 faces 108mm
- Chave 18 faces 135mm
- Chave de cinta Ø 160mm
- Chave 21mm



AI050172 205.30€

Chave de filtros ajustável de 1/2"

Medida: 104-150mm



AN010235 76.80€

Chave de 3/4" para instalação/ remoção de fêmea embraiagem

- Diâmetro interno: 64mm
- Diâmetro externo: 79mm
- Comprimento: 78mm
- Espigões: 7mm
- Aplicação: SCANIA



AN010237 143.90€

Extrator para articulações tirante de travões

Haldex



AN04005

Chave para remoção da tampa do cubo da roda traseira

Ref.	Medida (mm)	Preço
AN040055	111	175.00€
AN040056	120	179.60€

AN040062 38.60€

Chave de desmontagem da camisa dos injetores

Aplicação: SCANIA/ MERCEDES/ MAN



AN040066 213.50€

Saca rótulas

Medida: 39mm

Aplicação: SCANIA/ MERCEDES/ MAN/ HINO



AN040105 184.10€

Chave para roda traseira com 8 faces de 1"

Medida: 100mm

Aplicação: SCANIA



AN040200 131.50€

Chave cubo para roda dianteira de 1"

Medida: 80mm

Aplicação: SCANIA





JONNESWAY®

Ferramenta Pneumática



**Ferramenta
pneumática**

**Acessórios
para redes de
ar comprimido**



JAI-1024

218.70€

Máquina compacta de impacto de 1/2"

Caraterísticas:

Rotações em vazio:	10 000rpm
Torque trabalho:	510Nm
Torque máximo:	570Nm
Comprimento:	99mm
Peso:	1 400g
Consumo ar:	127l/min
Pressão de funcionamento:	6,2bar
Ruído:	97dB



JAI-1024-RK

13.10€

Kit de reparação para JAI-1024



JAI-1124

219.50€

Máquina compacta de impacto de 1/2"

Máquina ultra leve em compósito com mecanismo de 2 percutores e 3 velocidades de aperto e 1 velocidade de desaperto (potência máxima). Cobertura frontal em liga alumínio resistente.

Caraterísticas:

Rotações em vazio:	9 500rpm
Torque trabalho:	560Nm
Torque máximo:	620Nm
Comprimento:	112mm
Peso:	1 150g
Consumo ar:	136l/min
Pressão de funcionamento:	6,2bar
Ruído:	99,9dB



BREAKAWAY

torque **1 100Nm**

JAI-1124-RK

14.70€

Kit de reparação para JAI-1124



JAI-1114

226.20€

Máquina de impacto de 1/2"

Máquina em compósito preparada para trabalho intensivo com mecanismo de 2 percutores.

Caraterísticas:

Rotações em vazio:	9 500rpm
Torque trabalho:	880Nm
Torque máximo:	1 356Nm
Comprimento:	190mm
Peso:	2 300g
Consumo ar:	207l/min
Pressão de funcionamento:	6,2bar
Ruído:	99,2dB



JAI-1114K

311.20€

Máquina pneumática de impacto de 1/2" com kit de chaves

Máquina em compósito preparada com mecanismo de 2 percutores.

Caraterísticas:

Rotações em vazio:	9 500rpm
Torque trabalho:	880Nm
Torque máximo:	1 356Nm
Comprimento:	190mm
Peso:	2 300g
Interior mangueira:	10mmø
Consumo ar:	207l/min
Ruído:	99,2dB



Acessórios:

- 10 Chaves impacto de 1/2": 9; 10; 11; 13; 17; 19; 22; 24 e 27mm
- 1 Extensão de 125mm

JAI-1114-RK

17.40€

Kit de reparação para JAI-1114

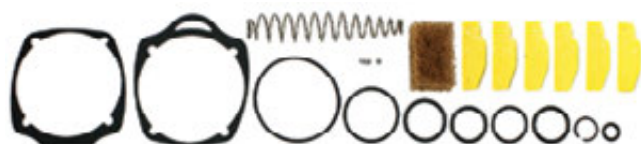

JAI-1524

169.40€

Máquina pneumática de impacto de 1/2"

Máquina em compósito para trabalho intensivo preparada com mecanismo de 2 percutores.

Caraterísticas:

Rotações em vazio:	8 500rpm
Torque trabalho:	840Nm
Torque máximo:	1 080Nm
Comprimento:	190mm
Peso:	2 500g
Interior mangueira:	10mmø
Consumo ar:	125l/min
Ruído:	104,8dB
Posições de aperto:	3
Posições de desaperto:	1



JAI-1524-RK

12.00€

Kit de reparação para JAI-1524



JAI-0954

285.60€

Máquina de impacto de 1/2"

Máquina em compósito preparada com mecanismo de 2 percutores (Twin Hammer).

Caraterísticas:

Rotações em vazio:	8 500rpm
Torque trabalho:	880Nm
Torque máximo:	1 356Nm
Comprimento:	181mm
Peso:	1 900g



JAI-0954-RK

25.20€

Kit de reparação para JAI-0954



JAI-1232K

201.50€

Máquina para remoção de velas de incandescência de 1/4" com kit de chaves

Máquina com comutador de direção incorporado no botão de acionamento, permitindo efetuar a mudança de direção só com uma mão. 4 Posições reguláveis para 20; 30; 40 e 45Nm

Caraterísticas:

Rotações em vazio:	11 000rpm
Torque:	20-45Nm
Comprimento:	180mm
Peso:	800g
Consumo ar:	150l/min
Pressão de funcionamento:	6,2bar
Ruído:	102dB

Acessórios:

Chaves caixa longas: 8; 9; 10; 11 e 12mm
Cardan
Extensão



JAI-1232-RK

16.50€

Kit de reparação para JAI-1232



JAI-1054

265.00€

Máquina de impacto de 1/2"

Máquina para trabalho intensivo com mecanismo de 2 percutores.

Caraterísticas:

Rotações em vazio:	8 000rpm
Torque trabalho:	780Nm
Torque máximo:	920Nm
Comprimento:	186mm
Peso:	2 560g
Interior mangueira:	13mmø
Consumo ar:	119l/min
Ruído:	90dB



JAI-1054-RK

29.20€

Kit de reparação para JAI-1054

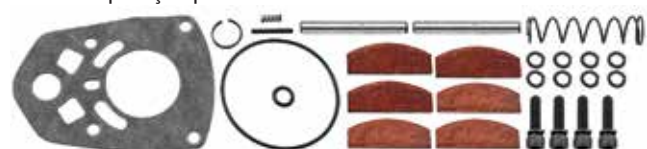

JAI-1513

286.50€

Máquina pneumática de impacto angular de 3/8"

Caraterísticas:

Rotações em vazio:	6 500rpm
Torque trabalho:	339Nm
Torque máximo:	380Nm
Comprimento:	248mm
Peso:	1 350g
Interior mangueira:	10mmø
Consumo ar:	119l/min
Ruído:	105dB



JAI-1513-RK

25.10€

Kit de reparação para JAI-1513



JAI-1514

275.20€

Máquina pneumática de impacto angular de 1/2"

Caraterísticas:

Rotações em vazio: 6 500rpm
 Torque trabalho: 407Nm
 Torque máximo: 460Nm
 Comprimento: 248mm
 Peso: 1 400g
 Interior mangueira: 10mmø
 Consumo ar: 119l/min
 Ruído: 105dB



JAI-1514-RK

25.60€

Kit de reparação para JAI-1514



JAI-0926-RK

50.60€

Kit de reparação para JAI-0926



JAI-0936

757.70€

Máquina de impacto de 3/4"

Máquina em compósito preparada para trabalho intensivo com mecanismo de 2 percutores.

Caraterísticas:

Rotações em vazio: 6 500rpm
 Torque trabalho: 1 620Nm
 Torque máximo: 2 025Nm
 Comprimento: 225mm
 Peso: 1 940g
 Interior mangueira: 13mmø
 Consumo ar: 190l/min
 Ruído: 90,5dB



JAI-0936-RK

73.50€

Kit de reparação para JAI-0936



JAI-6212K

523.70€

Máquina de impacto de 3/4" com kit de chaves

Máquina com mecanismo pin clutch.

Caraterísticas:

Rotações em vazio: 4 800rpm
 Torque máximo: 1 086Nm
 Peso: 4 900g
 Interior mangueira: 13mmø

Acessórios:

Chaves: 26-38mm
 Mala



JAI-6212-RK1

25.00€

Kit de reparação para JAI-6212

JAI-6211

484.10€

Máquina de impacto de 3/4" (19mm)

Máquina com mecanismo de 2 percutores.

Caraterísticas:

Rotações em vazio: 6 500rpm
 Torque máximo: 1 016Nm
 Peso: 4 550g
 Interior mangueira: 13mmø



JAI-6211-RK

47.60€

Kit de reparação para JAI-6211



JAI-1206L

1 002.90€

Máquina de impacto de 3/4"

Máquina para trabalho intensivo com veio longo e mecanismo de 2 percutores.

Caraterísticas:

Rotações em vazio: 5 500rpm
 Torque trabalho: 2 100Nm
 Torque máximo: 2 300Nm
 Comprimento: 465mm
 Peso: 6 400g
 Interior mangueira: 19mmø
 Consumo ar: 212l/min
 Ruído: 106dB



JAI-1206L-RK

72.60€

Kit de reparação para JAI-1206



JAI-0938

846.90€

Máquina de impacto de 1"

Máquina em compósito para trabalho intensivo com mecanismo de 2 percutores.

Caraterísticas:

Rotações em vazio:	6 500rpm
Torque trabalho:	1 740Nm
Torque máximo:	2 150Nm
Comprimento:	230mm
Peso:	4 100g
Consumo ar:	190l/min
Pressão de funcionamento:	6,2bar
Ruído:	190,5dB



JAI-0938-RK

75.40€

Kit de reparação para JAI-0938



JAI-1138

866.00€

Máquina de impacto de 1"

Máquina de veio curto com mecanismo de 2 percutores.

Caraterísticas:

Rotações em vazio:	5 000rpm
Torque trabalho:	2 430Nm
Torque máximo:	2 712Nm
Comprimento:	347mm
Peso:	7 400g
Interior mangueira:	19mmø
Consumo ar:	255l/min
Ruído:	100dB



JAI-1138-RK

109.50€

Kit de reparação para JAI-1138/ JAI-1138L



JAI-1138L

911.20€

Máquina de impacto de 1"

Máquina de veio longo com mecanismo de 2 percutores.

Caraterísticas:

Rotações em vazio:	5 000rpm
Torque trabalho:	2 430Nm
Torque máximo:	2 712Nm
Comprimento:	487mm
Peso:	8 300g
Interior mangueira:	19mmø
Consumo ar:	255l/min
Ruído:	100dB



JAI-1408

1 537.70€

Máquina de impacto pesados de 1"

Máquina de veio curto.

Caraterísticas:

Rotações em vazio:	4 800rpm
Torque trabalho:	3 270Nm
Torque máximo:	3 520Nm
Comprimento:	370mm
Peso:	10 500g
Consumo ar:	450l/min
Pressão de funcionamento:	6,3bar
Ruído:	105,5dB



JAI-1408-RK

101.50€

Kit de reparação para JAI-1408/ JAI-1408L



JAI-1408L

1 636.90€

Máquina de impacto pesados de 1"

Máquina de veio longo.

Caraterísticas:

Rotações em vazio:	4 800rpm
Torque trabalho:	3 270Nm
Torque máximo:	3 520Nm
Comprimento:	570mm
Peso:	11 900g
Consumo ar:	450l/min
Pressão de funcionamento:	6,3bar
Ruído:	105,5dB



JAI-6202-RK

77.50€

Kit de reparação para JAI-6202



JAI-0501-RK

26.20€

Kit de reparação para JAI-0501

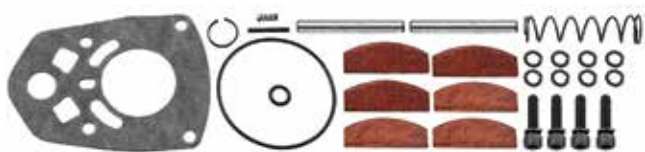

JAR-1012

105.90€

Roquete pneumático de 1/4"

Caraterísticas:
 Rotações em vazio: 230rpm
 Torque máximo: 40Nm
 Comprimento: 140mm
 Peso: 469g
 Interior mangueira: 10mmø
 Consumo ar: 338l/min



JAR-1012-RK

40.50€

Kit de reparação para JAR-1012



JAR-1013

104.80€

Roquete pneumático de 3/8"

Caraterísticas:
 Rotações em vazio: 230rpm
 Torque máximo: 40Nm
 Comprimento: 140mm
 Peso: 469g
 Interior mangueira: 10mmø
 Consumo ar: 338l/min



JAR-1013-RK

40.50€

Kit de reparação para JAR-1013



JAR-1094

136.70€

Roquete pneumático de 1/2"

Caraterísticas:
 Rotações em vazio: 170rpm
 Torque máximo: 100Nm
 Comprimento: 275mm
 Peso: 1 400g
 Interior mangueira: 10mmø
 Consumo ar: 113l/min
 Ruído: 87dB



JAR-1094-RK

44.20€

Kit de reparação para JAR-1094



JAR-6309AK

169.60€

Roquete pneumático de 1/2" com kit de chaves

Caraterísticas:
 Rotações em vazio: 170rpm
 Torque máximo: 100Nm
 Comprimento: 275mm
 Peso: 1 400g
 Interior mangueira: 10mmø



Acessórios:

Chaves: 9; 10; 11; 13; 14; 17 e 19mm
 Extensão: 75mm
 União universal de 1/2"
 Bits e porta bits
 Mala



JAR-6309A-RK

35.70€

Kit de reparação para JAR-6309A



JAR-6310A

119.10€

Roquete pneumático de 3/8"

Caraterísticas:
 Rotações em vazio: 170rpm
 Torque máximo: 100Nm
 Comprimento: 275mm
 Peso: 1 300g
 Interior mangueira: 10mmø



JAR-6310A-RK

34.60€

Kit de reparação para JAR-6310A



JAR-6310AK

167.30€

Roquete pneumático de 3/8" com kit de chaves

Caraterísticas:

Rotações em vazio: 170rpm
Torque máximo: 100Nm
Comprimento: 275mm
Peso: 1 300g
Interior mangueira: 10mmø



Acessórios:

Chaves: 9; 10; 11; 13; 14; 17 e 19mm
Extensão: 75mm
União universal de 3/8"
Bits e porta bits
Mala



JAR-1033

410.20€

Roquete pneumático combinado de 3/4" com kit de chaves

Caraterísticas:

Rotações em vazio: 180rpm
Torque máximo: 107Nm
Comprimento: 9,5mm
Peso: 1 400g
Interior mangueira: 10mmø



Acessórios:

Chaves: 8 a 19mm
Adaptadores



JAR-1033-RK

95.20€

Kit de reparação para JAR-1033A



JAD-0212

136.10€

Berbequim pneumático de 1/4"

Máquina em compósito.

Caraterísticas:

Rotações em vazio: 1 800rpm
Potência: 2cv
Comprimento: 199mm
Peso: 780g
Interior mangueira: 10mmø
Consumo ar: 54,4l/min
Ruído: 97dB



JAD-0212-RK

12.20€

Kit de reparação para JAD-0212



JAD-0413

138.40€

Berbequim reversível pneumático de 3/8"

Caraterísticas:

Rotações em vazio: 1 800rpm
Motor: 0,4cv
Capacidade da bucha: 10mm
Comprimento: 210mm
Peso: 950g
Interior mangueira: 10mmø
Consumo ar: 99l/min
Vibração: 3,3m/s²
Ruído: 80dB



JAD-0413-RK

14.40€

Kit de reparação para JAD-0413



JAD-0534

379.80€

Berbequim pneumático de 1/2"

Caraterísticas:

Potência: 0,6cv
Rotações em vazio: 7 000rpm
Comprimento: 240mm
Peso: 1 400g
Consumo de ar: 113 l/m
Ruído em carga: 97 dB



JAD-0534-RK

107.90€

Kit de reparação para JAD-0534



JAD-1020

127.80€

Berbequim reversível pneumático de 1/2"

Caraterísticas:

Rotações em vazio: 800rpm
 Capacidade da bucha: 13mm (aperto com chave)
 Comprimento: 220mm
 Peso: 1 300g
 Interior mangueira: 10mmø



JAD-1020-RK

3.00€

Kit de reparação para JAD-1020



JAD-1021

145.40€

Berbequim pneumático angular de 3/8"

Caraterísticas:

Rotações em vazio: 1 900rpm
 Capacidade da bucha: 10mm (aperto com chave)
 Comprimento/ altura: 190x110mm
 Peso: 960g
 Interior mangueira: 10mmø
 Consumo ar: 280l/min



JAD-1021-RK

16.50€

Kit de reparação para JAD-1021



JAD-1027

161.10€

Berbequim reversível pneumático de 1/2"

Caraterísticas:

Rotações em vazio: 800rpm
 Capacidade da bucha: 13mm (aperto sem chave)
 Comprimento: 178mm
 Peso: 1 820g
 Interior mangueira: 10mmø



JAD-1027-RK

2.90€

Kit de reparação para JAD-1027



JAD-6249

136.10€

Berbequim pneumático angular de 3/8"

Caraterísticas:

Rotações em vazio: 1 800rpm
 Capacidade da bucha: 3/8-10mm (aperto com chave)
 Comprimento: 210mm
 Peso: 1 080g
 Interior mangueira: 10mmø
 Consumo ar: 113l/min



JAD-6252A

87.10€

Berbequim pneumático de 3/8"

Caraterísticas:

Rotações em vazio: 2 500rpm
 Capacidade da bucha: 9,5mm (aperto com chave)
 Comprimento: 228mm
 Peso: 900g
 Interior mangueira: 10mmø



JAD-6252A-RK

4.80€

Kit de reparação para JAD-6252



JAB-1017

126.60€

Aparafusadora pneumática reversível de 1/4"

Caraterísticas:

Rotações em vazio: 1 800rpm
 Capacidade da bucha: 1/4"
 Comprimento: 190mm
 Peso: 1 100g
 Interior mangueira: 10mmø



JAB-1017-RK

2.50€

Kit de reparação para JAB-1017



JAB-1018

143.90€

Aparafusadora pneumática reversível de 1/4"

Caraterísticas:

Rotações em vazio: 800rpm
 Capacidade da bucha: 1/4"
 Comprimento: 226mm
 Peso: 1 300g
 Interior mangueira: 10mmø



JAB-1018-RK

2.50€

Kit de reparação para JAB-1018

JAB-7003A

149.90€

Aparafusadora pneumática reversível de 1/4"

Características:

Rotações em vazio: 1 800rpm
 Capacidade da bucha: 1/4"
 Comprimento: 254mm
 Peso: 1 140g
 Interior mangueira: 10mmø

JAB-7003A-RK

5.50€

Kit de reparação para JAB-7003A

JAD-1015K

406.90€

Máquina pneumática de descravar pontos com kit de acessórios

Características:

Rotações em vazio: 1 800rpm
 Capacidade de furo: 8mm
 Comprimento: 254mm
 Peso: 2 100g
 Interior mangueira: 10mmø



Acessórios:



Chave hexagonal: 2,5mm
 Brocas
 Lubrificador
 Ligador: 1/4"x1/4"
 Mala

JAD-1015-RK

3.10€

Kit de reparação para JAD-1015K

JAZ-7207

101.30€

Jogo de 5 brocas para máquina descravar

Aplicável aos modelos: JAD-1015/ JAD-6246

Características:

Brocas em HSS e cobalto
 Diâmetro: 6,5mmø

JAG-0903-MS

17.60€

Jogo de 10 buris

Aplicável aos modelos:

JAG-0903/ JAG-0906/ JAG-0913/ JAG-0923/ JAG-0925/ JAG-0955

JAG-0906RMK

101.70€

Retificadora pneumática de 1/4" com kit de acessórios

Características:

Rotações em vazio: 22 000rpm
 Capacidade da pinça: 6mm
 Potência: 0,4Kw
 Comprimento: 175mm
 Peso: 490g
 Interior mangueira: 10mmø



Acessórios:

Buris: 6mm (1/4")
 Buris: 3mm (1/8")
 Chaves
 Redução: 3mm (1/8")
 Mala

JAG-0906R/RM-RK

9.70€

Kit de reparação para JAG-0906RMK

JAG-0913RMK

125.00€

Retificadora pneumática angular de 1/4" com kit acessórios

Características:

Rotações em vazio: 18 000rpm
 Capacidade da pinça: 6mm
 Potência: 0,21Kw
 Comprimento: 155mm
 Peso: 490g
 Interior mangueira: 10mmø



Acessórios:

Buris: 6mm (1/4")
 Buris: 3mm (1/8")
 Chaves
 Redução: 3mm (1/8")
 Mala



JAG-0913RM-RK

6.70€

Kit de reparação para JAG-0913RMK



JAG-0923RM

64.50€

Mini retificadora pneumática de 1/4"

Caraterísticas:

Rotações em vazio: 25 000rpm
 Capacidade da pinça: 6mm
 Potência: 0,5hp
 Comprimento: 170mm
 Peso: 700g
 Consumo ar: 76l/min
 Pressão de funcionamento: 6,2bar
 Ruído: 97dB



JAG-0923RM-RK

7.30€

Kit de reparação para JAG-0923RM



JAG-0925RM

66.80€

Retificadora pneumática de 1/4"

Caraterísticas:

Rotações em vazio: 22 000rpm
 Capacidade da pinça: 6mm
 Potência: 0,5hp
 Comprimento: 170mm
 Peso: 700g
 Consumo ar: 113l/min
 Pressão de funcionamento: 6,2bar
 Ruído: 97dB



JAG-0925RM-RK

22.50€

Kit de reparação para JAG-0925RM



JAG-0955RM

101.60€

Retificadora pneumática de 1/4"

Caraterísticas:

Rotações em vazio: 22 000rpm
 Capacidade da pinça: 6mm
 Potência: 0,5hp
 Comprimento: 260mm
 Peso: 700g
 Consumo ar: 113l/min
 Pressão de funcionamento: 6,2bar
 Ruído: 97dB



JAG-0955RM-RK

9.10€

Kit de reparação para JAG-0955RM



JAG-1087

181.00€

Micro retificadora pneumática

Caraterísticas:

Rotações em vazio: 60 000rpm
 Bucha: 3mm
 Interior mangueira: 10mmø
 Peso: 220g
 Consumo ar: 180l/min
 Dimensões: 17x120mm



JAG-1087-RK

36.90€

Kit de reparação para JAG-1087



JAG-6638

197.30€

Rebarbadora pneumática angular de 125mm

Caraterísticas:

Rotações em vazio: 11 000rpm
 Dimensão do disco: 125mm
 Potência: 0,7Kw
 Comprimento: 230mm
 Peso: 1 800g
 Interior mangueira: 10mmø
 Vibração do punho: 6,45m/s²
 Ruído: 86dB



JAG-6638-RK

83.30€

Kit de reparação para JAG-6638



JAG-6639

367.90€

Rebarbadora pneumática angular de 180mm

Caraterísticas:

Rotações em vazio: 7 000rpm
 Dimensão do disco: 180mm (7")
 Potência: 1,4Kw
 Comprimento: 343mm
 Peso: 3 100g
 Interior mangueira: 10mmø



JAG-6639-RK

109.30€

Kit de reparação para JAG-6639

JAS-6505

206.30€

Lixadora de disco de 180mm

Características:

Rotações em vazio: 4 500rpm
 Dimensão do disco: 178mm
 Rosca do veio: 5,8" (11UNC)
 Comprimento: 406mm
 Peso: 2 500g
 Interior mangueira: 10mmø

JAS-6505-RK

7.50€

Kit de reparação para JAS-6505

JAS-6551

200.20€

Lixadora de disco de 180mm

Características:

Rotações em vazio: 2 500rpm
 Dimensão do disco: 178mm
 Rosca do veio: 5,8" (11UNC)
 Comprimento: 406mm
 Peso: 2 500g
 Interior mangueira: 10mmø

JAS-6551-RK

7.40€

Kit de reparação para JAS-6551

JAS-6552

203.40€

Polidora pneumática de 180mm

Características:

Rotações em vazio: 2 500rpm
 Dimensão do disco: 178mm
 Peso: 2 800g
 Interior mangueira: 10mmø
 Consumo ar: 260l/min

JAS-6552-RK

23.80€

Kit de reparação para JAS-6552

JAS-0010

294.00€

Lixadora com base triangular em vinil

Características:

Rotações em vazio: 9 000rpm
 Dimensão da base: 93x132mm
 Interior mangueira: 10mmø
 Consumo ar: 260l/min

JAS-0010-RK

28.00€

Kit de reparação para JAS-0010

JAS-0010-41

25.00€

Base para lixadora JAS-0010

Dimensão da base: 93x132mm

JAS-0413

150.80€

Lixadora orbital angular

Máquina em compósito

Características:

Rotações em vazio: 15 000rpm
 Dimensão do disco: 76mm
 Órbita: 3mm
 Motor: 0,4cv
 Comprimento: 125mm
 Peso: 720g
 Interior mangueira: 10mmø
 Consumo ar: 99l/min
 Vibração: 6,3m/s²
 Ruído: 80dB

JAS-0413-RK

13.10€

Kit de reparação para JAS-0413



JAS-0423K

191.70€

Polidora angular

Máquina em compósito

Caraterísticas:

- Rotações em vazio: 2 100rpm
- Dimensão do disco: 76mm
- Motor: 0,4cv
- Comprimento: 135mm
- Peso: 770g
- Consumo ar: 99l/min
- Pressão de funcionamento: 6,2bar
- Vibração: 2,3m/s²
- Ruído: 78dB



JAS-0423-RK

29.20€

Kit de reparação para JAS-0423



JAS-0423-31

14.30€

Base em velcro para JAS-0423



JAS-1021-6HE(2.5)

255.50€

Lixadora orbital angular com base em vinil aderente com 6"

Máquina em compósito

Caraterísticas:

- Rotações em vazio: 12 000rpm
- Dimensão do disco: 150mm
- Órbita: 2,5mm
- Peso: 960g
- Interior mangueira: 10mmø
- Consumo ar: 170l/min



JAS-1021-6HE-RK

12.50€

Kit de reparação para JAS-1021-6HE



JAS-1206-6HE

402.70€

Lixadora orbital para ligação a central de aspiração com base em vinil aderente com 6"

Máquina em compósito

Caraterísticas:

- Rotações em vazio: 12 000rpm
- Dimensão do disco: 150mm
- Órbita: 5mm
- Interior mangueira: 10mmø



JAS-1206-6HE-RK

56.00€

Kit de reparação para JAS-1206-6HE



JAS-1206-6HP

63.10€

Base com velcro para lixadora JAS-1206/ JAS-1207 com 6"



JAS-1207-6HE

448.70€

Lixadora orbital com auto aspiração com base em vinil aderente com 6"

Máquina em compósito

Caraterísticas:

- Rotações em vazio: 12 000rpm
- Dimensão do disco: 150mm
- Órbita: 5mm
- Interior mangueira: 10mmø
- Saco para recolha de pó



JAS-1207-6HE-RK

56.00€

Kit de reparação para JAS-1207-6HE



JAS-1207-6HE-56

34.50€

Saco em tecido para proteção do saco papel de recolha de pó para JAS-1207-6HE.



JAS-1207-6HE-57

4.30€

Saco em papel para recolha de pó para JAS-1207-6HE

JAS-1206-6HP

63.10€

Base com velcro para lixadora JAS-1206/ JAS-1207 com 6"

JAS-1031-6HE

254.10€

Lixadora orbital com base em velcro com 6"

Máquina em compósito

Caraterísticas:

Rotações em vazio:	10 000rpm
Dimensão do disco:	150mm
Órbita:	5mm
Peso:	1 040g
Interior mangueira:	10mmø

JAS-1031-6HE-RK

60.80€

Kit de reparação para JAS-1031-6HE

JAS-1031-6VE-RK

55.70€

Kit de reparação para JAS-1031-6VE

JAS-1031-6HP

28.40€

Base em velcro para lixadora JAS-1031/ JAS 6535-6HE

JAS-6531

169.30€

Lixadora retangular estreita

Máquina em compósito

Caraterísticas:

Movimentos/ minuto:	2 500
Dimensão da base:	63,5x407mm
Comprimento:	406mm
Peso:	3 100g
Interior mangueira:	10mmø
Consumo ar:	226l/min
Ruído:	93,3dB

JAS-6531-RK

3.50€

Kit de reparação para JAS-6531

JAS-6535-5HE

236.60€

Lixadora orbital com base em velcro com 5"

Máquina em compósito

Caraterísticas:

Rotações em vazio:	10 000rpm
Dimensão do disco:	125mm
Órbita:	5mm
Peso:	1 040g
Interior mangueira:	10mmø

JAS-6535-5HE-RK

63.20€

Kit de reparação para JAS-6535-5HE

JAS-6535-5HE-47

25.00€

Base em velcro para JAS-6535-5HE

JAS-6535-5VE-RK

46.50€

Kit de reparação para JAS-6535-5VE

JAS-6535-6HE

236.60€

Lixadora orbital com base em velcro com 6"

Máquina em compósito

Caraterísticas:

Rotações em vazio:	10 000rpm
Dimensão do disco:	150mm
Órbita:	5mm
Peso:	1 040g
Interior mangueira:	10mmø

JAS-6535-6HE-RK

57.70€

Kit de reparação para JAS-6535-6HE

JAS-1031-6HP

28.40€

Base em velcro para lixadora JAS-1031/ JAS 6535-6HE

JA-6111(1.4)

134.60€

Pistola de pintura tipo gravidade

Caraterísticas:

Entrada ar:	1/4"
Capacidade copo nylon:	600ml
Bico standard:	1,4mm



JA-6111

Kit de bico para pistola JA-6111

Ref.	Medida (mm)	Preço
JA-6111-NS13	1.3	54.20€
JA-6111-NS17	1.7	53.60€
JA-6111-NS20	2	53.60€



JA-6111K

281.60€

Jogo de pistola de pintura tipo gravidade e acessórios

Caraterísticas:

Pistola:	JA-6111
Capacidade copo nylon:	250 e 600 ml
Bicos:	1,7 e 2mm
Interior mangueira:	10mmø
Kit de limpeza	
Mala	



JA-HVLP-1080GK

354.20€

Jogo de pistola de pintura HVLP e acessórios

Caraterísticas:

Pistola:	JA-HVLP-1 080G
Capacidade copo nylon:	250 e 600ml
Bicos:	1,4; 1,7 e 2mm
Interior mangueira:	10mmø
Kit de limpeza	
Mala	



JA-HVLP-1080GD-N1.4

74.20€

Bico de 1.4 para pistola JA-HVLP-1 080GD



JA-HVLP-300C (1.3)

216.80€

Pistola de pintura tipo gravidade

Caraterísticas:

Entrada ar:	1/4"
Capacidade copo nylon:	600 ml
Bico standard:	1,3mm
Pressão ar:	2bar
Consumo ar:	481l/min
Peso:	545g
Interior mangueira:	10mmø



JA-HVLP-3000-NS17

85.70€

Kit bico 1.7 para pistola de pintura

JA-HVLP-3000-NS19

85.70€

Kit bico 1.9 para pistola de pintura

JA-300C-NS13

80.20€

Bico completo 1.3 para pistola de pintura JA-HVLP3000/ JA-HVLP300C

JA-LVLP-0303W

227.10€

Pistola de pintura para tintas à base de água tipo gravidade

Caraterísticas:

Entrada ar:	1/4"
Capacidade copo nylon:	600ml
Bico standard:	1,3mm
Interior mangueira:	10mmø



JA-LVLP-0303W-N

69.00€

Kit bico 1.3 para pistola de pintura



JA-LVLP-0303W-N18

69.00€

Kit bico 1.8 para pistola de pintura

JA-HVLP-6112

201.70€

Pistola de pintura tipo gravidade

Caraterísticas:

Entrada ar:	1/4"
Capacidade copo nylon:	125ml
Bico standard:	1mm
Pressão ar:	3bar
Consumo ar:	112l/min
Peso:	240g
Interior mangueira:	10mmø



ACC-609

27.40€

Regulador de ar 0-10 bar



JA-3806C
14.00€
Regulador de pressão para pistola de pintura

Aplicável à pistola JA-HVLP-6112

Características técnicas:

Pressão: 0-10 bar (0-140 PSI)

Rosca: 1/4"

JA-3808A
13.70€
Separador de óleo/ água para pistolas de pintura

Rosca: 1/4"

Válvula de drenagem

JA-0001RK
7.20€
Kit de reparação para pistola de pintura

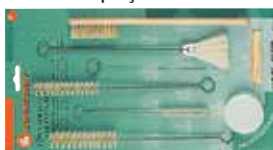
AS-0049
29.00€
Kit de limpeza para pistolas de pintura com 17 peças

AS-0013A2
34.00€
Copo de alumínio para pistola de pintura tipo gravidade

Capacidade: 600ml

AS-001
Copo para pistola de pintura

Ref.	Capacidade (ml)	Preço
AS-0013	600	18.10€
AS-0015	125	11.70€

JA-300C-28
17.40€
Copo para pistola de pintura JA-HVLP-3000

Capacidade: 600ml

Tampa não incluída

AS-001
Tampa para copo de pistola de pintura

Ref.	Capacidade (ml)	Preço
AS-0013C	600	5.30€
AS-0015C	250	5.00€

JA-950
92.00€
Pistola de secagem para tintas à base de água

JA-950-04
5.20€
Filtro de rede para pistola JA-950
JA-960
253.70€
Suporte para 2 pistolas de secagem

Não inclui as pistolas

JAS-0452
237.60€
Lixadora de faixa larga

Máquina em compósito

Características:

Rotações em vazio: 16 000rpm

Dimensão da base: 20x520mm

Comprimento: 430mm

Peso: 1 400g

Interior mangueira: 10mmø

Consumo ar: 113l/min

 Vibração: 2,8m/s²

Ruído: 95dB



JAS-0452-RK 47.10€

Kit de reparação para JAS-0452

JAS-6542 236.00€

Lixadora de faixa larga

Caraterísticas:

Rotações em vazio: 16 000rpm
Lixa: 20x520mm
Comprimento: 360mm
Peso: 1 200g
Interior mangueira: 10mmø



JAS-6542-RK 33.40€

Kit de reparação para JAS-6542

JAS-6543 145.50€

Lixadora de faixa estreita

Caraterísticas:

Rotações em vazio: 16 000rpm
Lixa: 10x330mm
Comprimento: 290mm
Peso: 800g
Interior mangueira: 10mmø



JAS-6543-RK 27.10€

Kit de reparação para JAS-6543

JAT-1020K 328.40€

Serra/ lima pneumática de baixa vibração com kit de acessórios
Mecanismo de baixa vibração

Caraterísticas:

Oscilação por minuto: 16 000bpm
Curso: 25mm
Peso: 960g
Interior mangueira: 10mmø



Acessórios:

Lâminas: T14; T18 e T24
Limas
Mala



JAT-1020-RK 73.90€

Kit de reparação para JAT-1020

JAT-12F

Limas para JAT-1020

Ref.	Forma	Preço
JAT-12F1	triangular	7.90€
JAT-12F2	meia cana	8.30€
JAT-12F3	redonda	8.10€
JAT-12F4	chata	7.60€



JAT-20T

Serras para JAT-1020

Ref.	Dentes	Preço
JAT-20T14	14	5.60€
JAT-20T18	18	5.60€
JAT-20T24	24	5.60€



JAT-1041 207.10€

Assentador pneumático de válvulas

Caraterísticas:

Oscilação por minuto: 3 000bpm
Capacidade máxima: 4,5mmø
Comprimento: 153,5mm
Peso: 1 550g
Interior mangueira: 10mmø
Consumo ar: 100l/min
Ventosas: 16; 20; 30 e 35mm



JAT-1041-16S 28.50€

Jogo de 4 ventosas para JAT-1041

Caraterísticas:

Medidas: 16; 20; 30 e 35mm



JAT-1011 184.40€

Serra pneumática de baixa vibração

Caraterísticas:

Oscilação por minuto: 11 000bpm
Curso: 8mm
Peso: 450g
Interior mangueira: 10mmø
Consumo ar: 90l/min
Ruído: 86,8dB



JAT-1011-RK 32.80€

Kit de reparação para JAT-1011

JAT-6613 242.00€
Máquina pneumática de decapar

Características:

Diâmetro base: 105mm
 Rotações em vazio: 3.500rpm
 Entrada ar: 1/4"
 Dimensões (comp/alt): 203x106mm
 Peso: 960g
 Consumo ar: 280l/min
 Ruído: 98dB

JAT-6613-P 17.60€
Disco de borracha para JAT-6613

JAT-6613-PA 19.10€
Disco abrasivo de limpeza para JAT-6613

JAT-6613-RK 33.90€
Kit de reparação para JAT-6613
JAT-6676 153.30€
Serra pneumática

Características:

Capacidade de corte: 1,6mm (espessura aço)
 Oscilação por minuto: 10 000bpm
 Curso: 10mm
 Comprimento: 235mm
 Peso: 960g
 Interior mangueira: 10mmø

JAT-6676-RK 8.90€
Kit de reparação para JAT-6676
JAT-10T
Serras para JAT-6676 5 unidades

Ref.	Dentes	Compr. (mm)	Preço
JAT-10T18	18	75	18.50€
JAT-10T32	32	75	18.50€

JAT-6421 58.30€
Máquina de corte pneumática de discos com 3"

Características:

Rotações em vazio: 20 000rpm
 Peso: 1 040g
 Interior mangueira: 10mmø

JAT-6421-RK 16.70€
Kit de reparação para JAT-6421

JAT-6421-33 2.50€
Disco de serra para JAT-6421
JAT-6441K 169.10€
Faca pneumática com kit de acessórios

Características:

Oscilação por minuto: 22 000bpm
 Comprimento: 120mm
 Peso: 1 200g
 Interior mangueira: 10mmø



Acessórios:

 Lâminas: 30; 35 e 57mm
 Mala

JAT-6441-RK 2.20€
Kit de reparação para JAT-6441
CF-K
Lâminas para JAT-6441K

Ref.	Compr. (mm)	Preço
CF-K-C	35	13.80€
CF-K-E	57	10.80€
CF-K-F	90	27.30€
CF-K-G	24	16.10€
CF-K-I	36	22.20€
CF-K-J	63	23.80€



JAT-6443K

207.60€

Ferramenta de corte por oscilação

Caraterísticas:

Amplitude de corte: 3mm
 Potência: 0,3cv
 Oscilação por minuto: 20 000bpm
 Comprimento: 180mm
 Peso: 700g
 Consumo de ar: 54l/m
 Ruído em carga: 95dB



Acessórios:

8 acessórios de corte

JAT-6443-RK

16.70€

Kit de reparação para JAT-6443



JAT-6443-K

Acessórios de corte para JAT-6443

Ref.	Tipo lâmina	Compr. (mm)	Preço
CF-K-E	Corte	57	10.80€
JAT-6443-K1	Corte nivelado	10	6.80€
JAT-6443-K2	Corte nivelado	20	6.80€
JAT-6443-K3	Corte nivelado	30	7.80€
JAT-6443-K4	Raspadora	51	6.80€
JAT-6443-K5	Lixadora triangular	80	9.30€
JAT-6443-K6	HSS meia lua	88	27.40€
JAT-6443-K7	Meia lua rebarbar	64	13.70€



JAT-6952

113.90€

Tesoura pneumática direita

Caraterísticas:

Oscilação por minuto: 2 300/ 2 500bpm
 Capacidade de corte: 1,2mm (espessura aço)
 Tamanho do corte: 5,5mm
 Comprimento: 255mm
 Peso: 1 000g
 Interior mangueira: 10mmø



Acessórios:

Lâminas: 30; 35 e 57mm

JAT-6952-RK

2.20€

Kit de reparação para JAT-6952

JAT-6952P

124.10€

Tesoura pneumática

Caraterísticas:

Oscilação por minuto: 2 200bpm
 Capacidade de corte: 1,2mm (espessura aço)
 Tamanho do corte: 5,5mm
 Comprimento: 215mm
 Peso: 1 200g
 Interior mangueira: 10mmø



JAT-6952P-RK

2.20€

Kit de reparação para JAT-6952P

JAT-6952P

Lâminas para JAT-6952/P

Ref.	Lâmina	Preço
JAT-6952P-37	esquerda	13.10€
JAT-6952P-39	central	15.50€
JAT-6952P-40	direita	13.10€

JAT-6943A

144.70€

Alicate pneumático de rebaixos

Caraterísticas:

Capacidade de corte: 1,4mm
 Capacidade de rebaixo: 8mm
 Quinagem: 12mm
 Comprimento: 248mm
 Peso: 1 300g
 Interior mangueira: 10mmø



JAT-6943A-RK

11.10€

Kit de reparação para JAT-6943A

JAT-6412

90.50€

Reboreadora pneumática

Caraterísticas:

Velocidade de corte: 3 200rpm
 Capacidade de corte: 1,4mm (espessura aço)
 Comprimento: 210mm
 Peso: 1 000g
 Interior mangueira: 10mmø



JAT-6412-RK

2.20€

Kit de reparação para JAT-6412

JAH-0288 137.30€

Martelo pneumático de agulhas

Caraterísticas:
 Pancadas por minuto: 5 000
 Número de agulhas: 12
 Comprimento: 290mm
 Peso: 1 200g
 Consumo ar: 90l/min
 Interior mangueira: 10mmø

JAH-0288-15 18.20€

Cinzel para JAH-0288
JAH-0288-16 9.40€

Jogo de agulhas para JAH-0288
JAH-0288-17 7.00€

Alojamento de agulhas para JAH-0288
JAH-0288-RK 30.40€

Kit de reparação para JAH-0288
JAH-308HK 216.90€

Martelo pneumático de baixa vibração

Caraterísticas:
 Encaixe hexagonal
 Curso do pistão: 64mm
 Golpes por minuto: 3 000
 Comprimento: 230mm
 Peso: 2 000g
 Consumo de ar: 170l/m



Acessórios:
 5 acessórios
 Mala

JAH-308H-RK 8.40€

Kit de reparação para JAH-308H

JAH-6837 186.80€

Martelo burilador direito

Caraterísticas:
 Golpes por minuto: 4 600
 Encaixe: 25,4x43,5
 Comprimento: 380mm
 Peso: 2 100g
 Interior mangueira: 10mmø

JAH-6837-RK 25.00€

Kit de reparação para JAH-6837
JAH-6837-5
Cinzel para JAH-6837

Ref.	Tipo	Compr. (mm)	Preço
JAH-6837-50	plano	35-175	21.40€
JAH-6837-50-2	ponteiro		23.30€

JAH-7104H 460.20€

Martelo pneumático de 1"

Caraterísticas:
 Golpes por minuto: 2 820
 Comprimento: 308mm
 Peso: 5 500g
 Consumo ar: 228l/min
 Interior mangueira: 10mmø

JAH-7104H-RK 7.80€

Kit de reparação para JAH-7104H
JAZ-01
Buril hexagonal

Ref.	Tipo	Preço
JAZ-011H	bico	27.40€
JAZ-016H	ponta	27.40€

JAT-6034 154.00€

Rebitadora pneumática

Caraterísticas:
 Capacidade: 2,4 a 4,8mm (aço+aço inox)
 Potência tração: 10 250Nm
 Curso: 16mm
 Comprimento: 308mm
 Peso: 1 500g
 Interior mangueira: 10mmø

JAT-6034-RK 35.70€

Kit de reparação para JAT-6034

JAT-6034
Bicos para rebitadora JAT-6034

Ref.	Diâmetro (mm)	Preço
JAT-6034-1A	4,8	1.50€
JAT-6034-1B	4	1.50€
JAT-6034-1C	3,2	1.50€
JAT-6034-1D	2	1.50€



JAT-6673

420.30€

Rebitadora pneumática

Caraterísticas:
 Capacidade: 2,4 a 6,4mm (aço+aço inox)
 Curso: 18mm
 Peso: 1 750g
 Consumo ar: 2,9l/ciclo
 Interior mangueira: 10mmø



JAT-6673-RK

70.80€

Kit de reparação para JAT-6673

JAT-1035

613.60€

Rebitadora pneumática de fêmeas

Caraterísticas:
 Dimensões: 270x190mm
 Capacidade: M4-M10 (aço)
 Capacidade: M4-M8 (aço inox)
 Curso: 6mm
 Peso: 1 550g
 Consumo ar: 1,5l/ciclo
 Interior mangueira: 10mmø



JAT-1035-RK

9.30€

Kit de reparação para JAT-1035

JAT-460

38.70€

Bomba de massa manual de ponteira rígida

Acionamento por alavanca
 Capacidade: 400cc



JAT-481

56.20€

Bomba de massa manual de ponteira flexível

Acionamento por pistoleta
 Capacidade: 400cc



JAT-480-NS

12.90€

Ponteira flexível para JAT-480

Compatível com JAT-460



JAT-6004K

93.60€

Bomba de massa pneumática de ponteira rígida com acessórios

Acionamento por pneumático

Capacidade: 400cc

Acessórios:



Ponteira flexível
 Alavanca por acionamento manual

JAT-501

74.60€

Pistola pneumática para mastique

Caraterísticas:
 Entrada: 1/4"
 Capacidade: 310ml
 Pressão: 2,5 a 5,1bar
 Interior mangueira: 10mmø
 Cartucho tipo "Salsichão"



JA-5032

42.20€

Pistola pneumática para mastique

Caraterísticas:
 Pressão: 2 a 4bar
 Comprimento: 330mm
 Peso: 1 225g
 Consumo ar: 170l/min
 Interior mangueira: 10mmø
 Material: metal



JAZ-3811E

79.80€

Balaceiro

Caraterísticas:
 Capacidade de carga: 3 a 5kg
 Comprimento do fio: 1,5mt
 Diâmetro do fio: 3,2mm



JA-3812A

49.50€

Balaceiro

Caraterísticas:
 Capacidade de carga: 0,5 a 1,2kg
 Comprimento do fio: 1,6m
 Diâmetro do fio: 1,8mm
 Peso: 560g



JA-3812D

51.60€

Balaceiro

Caraterísticas:
 Capacidade de carga: 1 a 2kg
 Comprimento do fio: 1,6m
 Diâmetro do fio: 1,8mm
 Peso: 560g



JAT-6904S

22.60€

Pistolete para água com kit de acessórios com 5 bicos

JAT-6905B

21.50€

Pistolete de ar

JAT-6905S

41.20€

Pistolete de ar com conjunto de acessórios

JAT-6905-C

4.00€

 Bico para pistolete de ar
Bico triangular espalmado

JAT-6905-J

15.00€

 Bico para pistolete de ar
Bico com escova em nylon

JAT-6959

8.00€

Pistola para ar de bico longo de 1/4"

 Comprimento: 100mm
Pressão trabalho: 75-120psi
Ruído: 85-90dba
Fêmea: 1/4"

JAT-6959A

9.90€

Pistola para ar de bico longo de 1/4"

 Comprimento: 280mm
Pressão trabalho: 75-120psi
Ruído: 85-90dba
Fêmea: 1/4"

Acessórios para redes de ar comprimido

JAZ-000

Enrolador ar

Ref.	Mangueira ø (mm)	Mangueira compri.(m)	Preço
JAZ-0001B	8x12	15	167.10€
JAZ-0002A	8x12	9	123.70€
JAZ-0002B	9,5x13,3	7,5	119.80€
JAZ-0002C	6,5x10	10	123.30€

JAZ-39520

243.20€

Enrolador móvel para ar de 3/8"

 Comprimento: 20m
Pressão máxima: 15bar
Peso: 7 000g
Interior mangueira: 9,5mmø
Ligação: 3/8"

JA-725

Mini lubrificador óleo para máquinas pneumáticas

Ref.	Medida	Preço
JA-7253	1/4"	10.50€
JA-7254	3/8"	13.70€

JAZ-0042

19.10€

Cardan para máquinas pneumáticas 1/4"

JAZ-0513

Copo plástico para filtros lubrificadores JAZ-0512/ JAZ-0513

Ref.	Especif.	Preço
JAZ-0514-06	purga	3.00€
JAZ-0513-09	copo ar	7.10€
JAZ-0514-13	freio	0.45€
JAZ-0513-50	óleo	6.20€

JAZ-0514

Copo plástico para filtros lubrificadores JAZ-0514/ JAZ-0516

Ref.	Especif.	Preço
JAZ-0514-06	purga	3.00€
JAZ-0514-09	copo ar	11.70€
JAZ-0514-13	freio	0.45€
JAZ-0514-48	copo óleo	8.40€



JAZ-051

Filtro lubrificador com regulador de pressão



Ref.	Entrada	Fluxo (l/min)	Pressão (bar)	Filtro (µm)	Preço
JAZ-0512	1/4"	1 000	0,5-8,5	5	91.30€
JAZ-0513	3/8"	1 350	0,5-8,5	5	93.30€
JAZ-0514	1/2"	3 000	0,5-8,5	5	129.30€
JAZ-0516	3/4"	3 100	0,5-8,5	5	131.50€

Nota: A pressão máxima de alimentação é de 8.5bar

JAZ-6704A

Filtro lubrificador com regulador de pressão

Entrada	Fluxo (l/min)	Pressão (bar)	Filtro (µm)	Preço
1/2"	1 250	1-10	5	120.70€

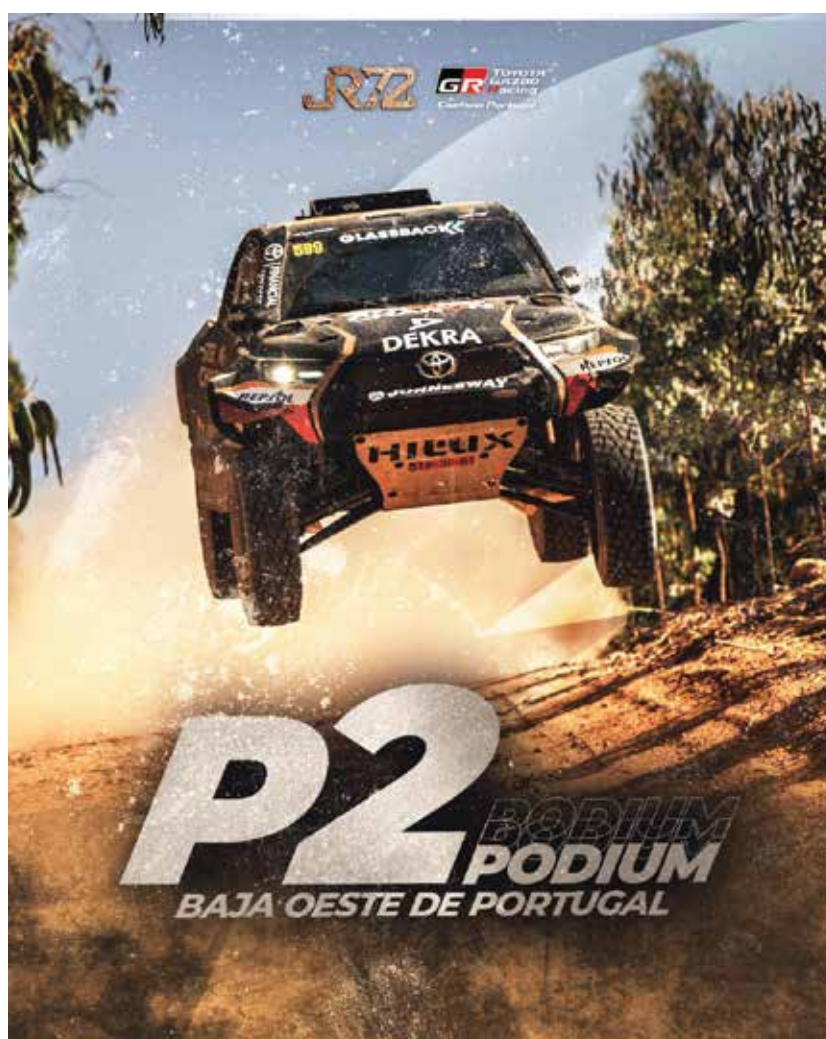

JAZ-6710A

Filtro de ar 1/2"

50.60€

JAZ-6711A

Regulador de pressão 1/2"

62.90€

JAZ-6712A

Lubrificador de ar 1/2"

51.60€

JAZ-6715A

Filtro de ar com regulador 1/2"

84.80€

JAZ-6704

Copo plástico para filtros lubrificadores JAZ-6704A/ JAZ-6710A

Ref.	Especif.	Preço
JAZ-6704-W	ar	12.40€
JAZ-6704-O	óleo	6.60€

JAZ-7214

Tubo espiral fêmea de 1/4"

Ref.	Medida (mm)	Compr. (m)	Preço
JAZ-7214F	5x8	13	31.10€
JAZ-7214S	6,5x10	13	39.60€
JAZ-7214Z	8x12	15	58.30€

GM-0

Tomada rápida fêmea

Ref.	Medida	Preço
GM-02AF	1/4"	7.80€
GM-03AF	3/8"	8.30€
GM-04AF	1/2"	8.30€

Acessórios para redes de ar comprimido
GM-0

Tomada rápida macho

Ref.	Medida	Preço
GM-02AM	1/4"	7.70€
GM-03AM	3/8"	7.70€
GM-04AM	1/2"	8.20€

GM-0

Tomada rápida tubo

Ref.	Medida	Preço
GM-02AH	1/4"	8.30€
GM-03AH	3/8"	8.80€
GM-04AH	1/2"	8.70€
GM-02BH	5/16"	8.50€

GM-0

Ponteira fêmea

Ref.	Medida	Preço
GM-02PF	1/4"	1.60€
GM-03PF	3/8"	2.70€
GM-04PF	1/2"	3.20€

GM-0

Ponteira macho

Ref.	Medida	Preço
GM-02PM	1/4"	1.40€
GM-03PM	3/8"	2.50€
GM-04PM	1/2"	3.00€

GM-0

Ponteira tubo

Ref.	Medida	Preço
GM-02PH	1/4"	1.60€
GM-03PH	3/8"	1.70€
GM-04PH	1/2"	2.00€
GM-02BPH	5/16"	1.60€

KIT AR

69.40€

Jogo de acessórios de ligação a rede de ar

Composição:

- GM-02AF Tomada rápida fêmea de 1/4"
- GM-02PF Ponteira fêmea de 1/4"
- GM-02PM Ponteira macho de 1/4"
- JAT-6905B Pistolete simples para ar
- JAZ-7214S Tubo espiral 13m





JONNESWAY®

Ferramentas Profissionais





JONNESWAY®

Merchandising



Merchandising

BOUTJW01A-M	20.20€
BOUTJW01A-L	20.20€
BOUTJW01A-XL	20.20€

T-shirt

Com o logotipo da Jonnesway estampado no peito e na manga, nos tamanhos M, L e XL.



BOUTJW02A	10.90€
------------------	--------

Boné

Com o logotipo da Jonnesway bordado.



JW-01B	21.90€
---------------	--------

Boné

Com o logotipo da Jonnesway bordado.



BOUTJW03B	82.70€
------------------	--------

Esferográfica 50 unidades

Com o logotipo da Jonnesway.



BOUTJW04A-M	63.20€
--------------------	--------

BOUTJW04A-L	63.20€
--------------------	--------

BOUTJW04A-XL	63.20€
---------------------	--------

Polar bege

Com o logotipo da Jonnesway bordado no peito, nos tamanhos M, L e XL.



BOUTJW05A	39.60€
------------------	--------

Guarda-chuva 1 unidade

Com o logotipo da Jonnesway estampado.



BOUTJW06B	52.40€
------------------	--------

Lona Jonnesway

Medidas: 1 480x890mm



BOUTJW07A-M	22.30€
--------------------	--------

BOUTJW07A-L	22.30€
--------------------	--------

BOUTJW07A-XL	22.30€
---------------------	--------

Polo

Com o logotipo da Jonnesway bordado no peito, nos tamanhos M, L e XL.



BOUTJW07B-M	35.00€
--------------------	--------

BOUTJW07B-L	35.00€
--------------------	--------

BOUTJW07B-XL	35.00€
---------------------	--------

Polo

Com o logotipo da Jonnesway bordado no peito, nos tamanhos M, L e XL.



BOUTJW08B-50 65.00€

BOUTJW08B-52 65.00€

BOUTJW08B-54 65.00€

Fato-macaco cinza

Com o logotipo da Jonnesway estampado no peito e nas costas.



JW-USB1 21.90€

Dispositivo de armazenamento de dados - pen USB 1 unidade
Capacidade: 32 Gb



BOUTJW13A 16.50€

Para-sol

Com o logotipo da Jonnesway.



BOUTJW14B 28.80€

Mochila

Com o logotipo da Jonnesway bordado.

Dimensões: 280x380x120mm



JW-BACKPACK 130.00€

Mochila



BOUTJW15B 94.30€

Esferográfica "touch" 50 unidades
Com o logotipo da Jonnesway.



BOUTJW16A 4.80€

Porta chaves 1 unidade



JW-KEYRING02 2.60€

Porta chaves "Martelo" 1 unidade



JW-KEYRING03 2.60€

Porta chaves "Chave Inglesa" 1 unidade



BOUTJW17A-1 4.50€

Autocolante Jonnesway
Medidas: 70x400mm



BOUTJW17A-2 10.80€

Autocolante Jonnesway
Medidas: 100x600mm



BOUTJW18A 5.40€

Esferográfica
Com o logotipo da Jonnesway.



BOUTJW19A 59.00€

Esferográfica "roller ball"
Com o logotipo da Jonnesway.



BOUTJW20A-M 40.60€

BOUTJW20A-L 40.60€

BOUTJW20A-XL 40.60€

Sweat shirt

Com o logotipo da Jonnesway bordado no peito,
nos tamanhos M, L e XL.



BOUTJW21A-M 118.80€

BOUTJW21A-L 118.80€

BOUTJW21A-XL 118.80€

Colete

Com o logotipo da Jonnesway bordado no peito,
nos tamanhos M, L e XL.



BOUTJW22A-M 75.50€

BOUTJW22A-L 75.50€

BOUTJW22A-XL 75.50€

Casaco

Com o logotipo da Jonnesway bordado no peito,
nos tamanhos M, L e XL.



BOUTJW23A-M 72.90€

BOUTJW23A-L 72.90€

BOUTJW23A-XL 72.90€

Calças

Com o logotipo da Jonnesway bordado,
nos tamanhos M, L e XL.



BOUTJW24A 13.30€

Bloco de notas A5

Com o logotipo da Jonnesway.

Medidas: 140x210mm



BOUTJW25B 50.90€

Pasta A4

Com o logotipo da Jonnesway estampado.

Medidas: 245x325x40mm



BOUTJW26A

82.00€

Mala para portátil

Com o logotipo da Jonnesway estampado.

Medidas: 410x300x80mm



BOUTJW27A

28.90€

Rato sem fios

Com o logotipo da Jonnesway.



BOUTJW28A

35.80€

Base carregadora por indução para telemóveis

Dimensões: 69x10mm

Caraterísticas:

Carregador por indução com potência de carga até 10w.

Inclui cabo USB/ micro USB.

Compatível com smartphones com tecnologia de carregamento sem fios.



BOUTJW29A

215.00€

Bandeira barbatana tubarão

Dimensões: 660x2000mm



C-DSP

637.90€

Expositor para ferramenta com painéis perfurados e 30 ganchos

Medidas:

Altura: 2 140mm

Profundidade: 660mm

Largura: 940mm



C-DSP-0WB10

1.60€

Gancho para expositor C-DSP



DS96

137.00€

Expositor vazio para chaves de fenda

Capacidade: 96 chaves

Dimensões: 595x240x210mm



C-DS14

208.10€

Expositor para chaves caixa

Dimensões: 350x420x350mm



JAZ-ST4

50.90€

Base em acrílico para máquinas pneumáticas



FITA JW

6.50€

Fita Jonnesway para embalagem



JW-OPENER

5.20€

Tira cápsulas





JONNESWAY®

Ferramentas Profissionais





JONNESWAY[®]

Outros Equipamentos



Outros equipamentos

AE020009

490.40€

Bomba hidropneumática

Pressão de serviço: 690bar
 Alimentação: 7-10bar
 Dimensões: 257,50x127x204,50mm
 Peso: 8 000g
 Capacidade: 1 660cc



AE060002

877.80€

Macaco para transmissões

Altura máxima: 750mm
 Altura mínima: 200mm
 Capacidade: 1t
 Dimensões: 865x480mm
 Peso: 60kg



AE060003

1 689.60€

Macaco para transmissões

Altura máxima: 890mm
 Altura mínima: 165mm
 Capacidade: 1,5t
 Dimensões: 1 105x652mm
 Peso: 130kg



AE070002A

705.80€

Macaco de fossa

Altura máxima: 1 835mm
 Altura mínima: 1 035mm
 Capacidade: 600kg

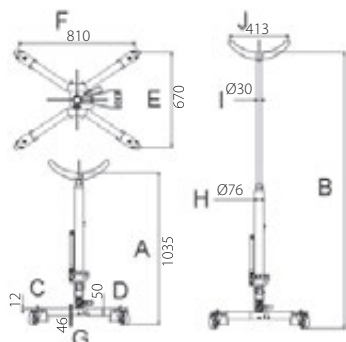

AE080001

979.10€

Macaco de fossa com prato universal

Altura máxima: 1 377mm
 Altura mínima: 880mm
 Capacidade: 500kg
 Prato: 729x597mm

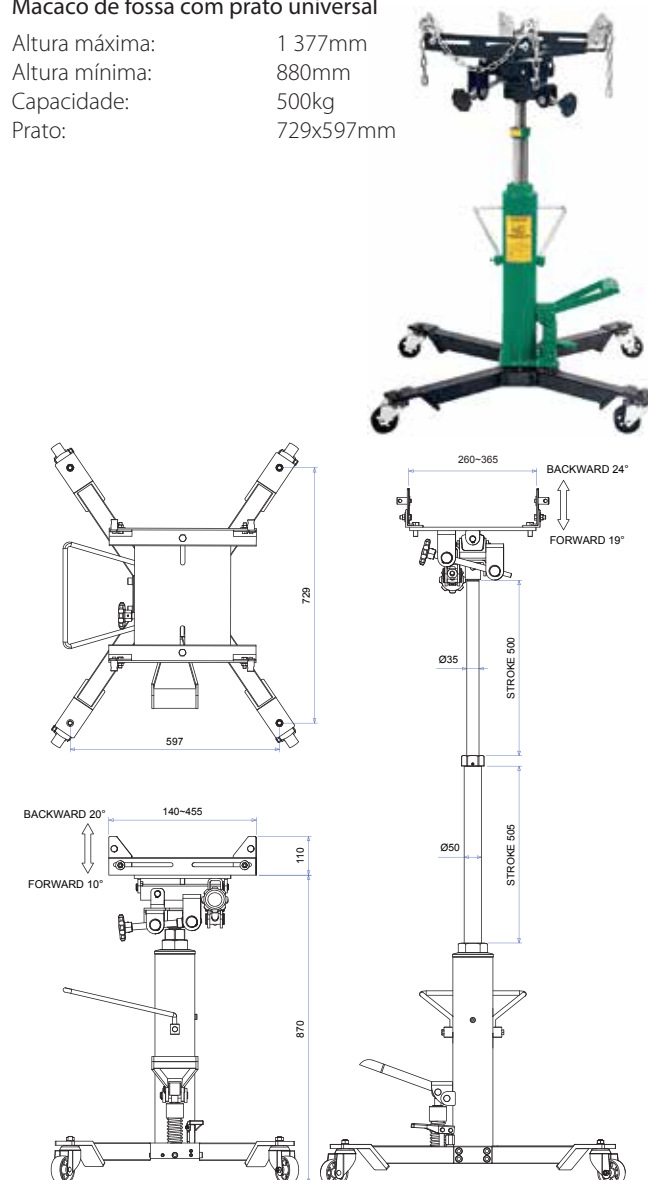

AG010236

77.80€

Suporte para movimentar pneus/ rodas



AG010154

18.00€

Banco plástico de apoio com rodas

Dimensões: 450x335x310mm
 Peso: 1 500g
 Capacidade carga máx: 100kg



AG010222

101.50€

Banco metálico com rodas

Dimensões: 330x350x560mm
 Capacidade: 130kg

Inclui:
 Gaveta
 Suportes laterais para peças



AE090105A

69.20€

Estrado para mecânico

Dimensões: 1 000x470x130mm
 Carga admissível: 120kg



Novo

AG010247

46.90€

Tapete de trabalho dobrável em Eva

Dimensões: 1 210x455x30mm



AE140015

514.30€

Suporte rotativo de motores para bancada

Capacidade carga máx: 450kg



AE110020

1 194.50€

Macaco hidropneumático

Altura máxima: 377mm
 Altura mínima: 205mm
 Capacidade: 20t

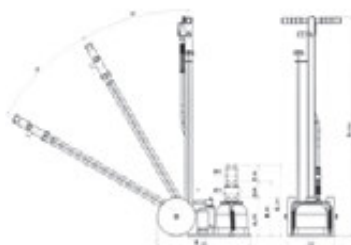

AE130003

1 315.40€

Grua hidráulica de 2t

Caraterísticas em mm:
 Altura mínima: 60
 Elevação máxima: 2 330
 Largura da base: 718-936
 Comprimento da base: 1 606-2 426
 Comprimento máximo braço: 1 960



AE130003-1

175.00€

Travessa

Capacidade: 500kg



AE140013

1 034.90€

Suporte articulado de motores

Capacidade: 600kg



AE150001

312.70€

Preguiça

Altura: 710-1 065mm

Capacidade: 12t



AE150002

248.70€

Preguiça para pesados

Altura: 456-710mm

Capacidade: 12t



AE170002

190.70€

Travessa para suporte de motores

Ajuste: 530-1 480mm



AE010025A

421.00€

Jogo prensa de chapeiro de 4t

Composição:
Bomba hidráulica manual
Cilindro hidráulico: 4t (369-522mm)
Pinça de alargamento
Adaptadores
Extensões
Mala com rodas



AE010015A

679.40€

Jogo prensa de chapeiro de 10t

Composição:
Bomba hidráulica manual
Cilindro hidráulico: 10t (369-522mm)
Pinça de alargamento
Adaptadores
Extensões
Mala com rodas



AE050003

204.00€

Macaco chapeiro 5t

Capacidade: 5t
Comprimento: 750mm
Curso pistão: 160mm



AE180001

274.60€

Travessa para portas

Comprimento: 74-115mm



AE200003

1 510.00€

Elevador para rodas veículos pesados

Capacidade: 600kg
Elevação: 395mm



AE300149

169.40€

Aparadeira de óleo

Aparadeira regulável em altura em polietileno de alta densidade com descarga por gravidade.

Capacidade: 50l
 Peso: 12kg
 Dimensões: 550x550x990~1 070 mm



AR020016

105.10€

Multímetro digital e analisador automóvel

Funções: RPM, dwell, volts AC/DC, amps DC, resistências, ciclo de trabalho, temperatura, testes díodos e teste continuidade.



AR020060

259.70€

Pinça amperimétrica

De acordo com a norma IEC 1010 CAT III 1 000V

Multímetro digital com escalas automáticas
 Multifunções para AC/DV amp; AC/DC V e Ohms
 Capacitância, frequência e díodos
 Proteção de sobrecarga
 Memória
 RMS (valor eficaz)

Pinça amperimétrica: 2 000A - AC/DC
 Gama medição: 2 000 A AC/400A DC



AR020061

194.60€

Multímetro digital

De acordo com a norma IEC 1010 CAT III 1 000V

Mostrador de grande dimensão
 Escalas automáticas AC/DC para voltagem, amperagem, capacitância, frequência e resistência
 Leitura até 10 Amp com proteção e impedância alta para leituras de mV
 Memória
 RMS (valor eficaz)



AR030067

44.60€

Medidor de voltagem multifuncional

Pilhas não incluídas

Leitura de corrente AC/DC: 12-690V
 Mostrador LED/LCD



C-T4A

636.80€

Bancada de trabalho cinzenta com 3 gavetas

Tampo metálico com cobertura em acrílico

Medidas:
 Altura: 800mm
 Profundidade: 700mm
 Largura: 1 525mm



C-T5G-DP

136.10€

Painel traseiro cinzento para bancada

Aplicação:
 Bancada: C-T4A

Medidas:
 Altura: 700mm
 Largura: 1 525mm



C-DBU1

2.90€

Gancho para painel traseiro de bancada

Aplicação:
 Painel: C-T5G-DP
 Armários: C-SA
 Comprimento: 25,4mm



C-DBU7

3.20€

Gancho para painel perfurado

Aplicação:
 Painel: C-T5G-DP
 Armários: C-SA
 Comprimento: 50,8mm



AB	Pág.						
AB010001	162	AB030076-21	164	AE300152	125	AE310146E	127
AB010002	162	AB030076-24	164	AE300154B	128	AE310146G	127
AB010002-A	162	AB030076-26	164	AE300168	129	AE310146H	127
AB010017	162	AB030076-27	164	AE300168-1	129	AE310150	128
AB010018	162	AB030076-28	164	AE300173	125	AE310172	128
AB010019	162	AB030076-30	164	AE300176-A	125	AE310172-1	128
AB010020	162	AB030076-32	164	AE300179-02	144	AE310180	128
AB010026S	162	AB030076-34	164	AE300179-03	144	AE310183	128
AB010041	163	AB030089	165	AE300180	144	AE320023	128
AB010043	163	AB030094J	164	AE300201	129	AE320034	128
AB020002	163	AB030100	165	AE300202	129	AE320044	128
AB020003A	163	AB030105	165	AE300204	129	AE330004	166
AB020009	163	AC	Pág.	AE300205	129	AE330005	166
AB020010	163	ACC-609	182	AE300206	129	AE330008	166
AB020015	163	AE0	Pág.	AE300207	129	AE330009	166
AB020019	163	AE010015A	202	AE300211	129	AE330013	166
AB030001	163	AE010025A	202	AE300212	125	AE330015	166
AB030014	163	AE020009	200	AE300215	130	AE330016	166
AB030028	163	AE040020	124	AE300220	130	AE330030	166
AB030041	163	AE040038	124	AE300221-02	144	AE330034	166
AB030043	163	AE050003	202	AE300221-03	144	AE330035	166
AB030046	163	AE060002	200	AE300221-04	144	AGO	Pág.
AB030047	163	AE060003	200	AE310002	125	AG010002	89
AB030048	163	AE070002A	200	AE310002-RK	125	AG010002S	88
AB030049	164	AE080001	200	AE310003	166	AG010002SP	26
AB030056	124	AE090105A	201	AE310004	166	AG010003	89
AB030060	164	AE1	Pág.	AE310006	125	AG010005	89
AB030061	124	AE110020	201	AE310008	126	AG010006	89
AB030068A	164	AE130003	201	AE310010A	126	AG010008	89
AB030068C	164	AE130003-1	201	AE310012	126	AG010009	89
AB030068D	164	AE140013	202	AE310016	126	AG010011	89
AB030068F	164	AE140015	201	AE310023	126	AG010012	89
AB030069A	164	AE150001	202	AE310024	125	AG010024	165
AB030069B	164	AE150002	202	AE310025	125	AG010024-1	165
AB030069E	164	AE150005	124	AE310026	125	AG010024-2	165
AB030070B	164	AE170002	202	AE310027	125	AG010026SP	26
AB030070C	164	AE180001	202	AE310034	127	AG010030A	165
AB030070D	164	AE2	Pág.	AE310035	127	AG010034	130
AB030071	165	AE200003	202	AE310037	127	AG010035	130
AB030076-00	164	AE3	Pág.	AE310038	127	AG010036	130
AB030076-01	164	AE300064	124	AE310062	126	AG010046	130
AB030076-02	164	AE300064-02	124	AE310063	126	AG010049	130
AB030076-03	164	AE300064-03	124	AE310066	126	AG010055	165
AB030076-05	164	AE300064-04	124	AE310073	126	AG010055-B	165
AB030076-06	164	AE300064-05	124	AE310077	126	AG010059	130
AB030076-07	164	AE300064-06	124	AE310087	126	AG010059-10	130
AB030076-11	164	AE300064-07	124	AE310099	126	AG010059-12	130
AB030076-13	164	AE300064-15	124	AE310109A	127	AG010059-6	130
AB030076-14	164	AE300064-16	124	AE310110	127	AG010059-8	130
AB030076-15	164	AE300100-040	124	AE310112	127	AG010089	130
AB030076-17	164	AE300100-042	124	AE310122	128	AG010099	131
AB030076-18	164	AE300100-060	124	AE310135	128	AG010109	131
AB030076-20	164	AE300103	124	AE310146B	127	AG010111	130
		AE300149	203	AE310146D	127	AG010118A	131

AG010138	166	AI010060-B	134	AI020127	157	AI050077	142
AG010138-B	166	AI010060-C	134	AI020131	137	AI050079	158
AG010140	167	AI010060-D	134	AI020142	137	AI050080	142
AG010141	167	AI010063A	134	AI020154	157	AI050085A	155
AG010142	167	AI010069	157	AI020158	137	AI050092	143
AG010143	167	AI010070	157	AI020162	137	AI050093	143
AG010147	131	AI010086	134	AI020163	137	AI050096S	143
AG010150SC	26	AI010090A	135	AI020164	167	AI050102	143
AG010154	201	AI010092	134	AI020178	137	AI050104	143
AG010159	131	AI010097	155	AI020180	137	AI050109	143
AG010163A	130	AI010104	134	AI020184	138	AI050110	143
AG010164	130	AI010107	154	AI020184A	138	AI050113	143
AG010167	131	AI010108	158	AI020184B	138	AI050135	168
AG010168	131	AI010110	159	AI020184S	138	AI050140A	143
AG010169	131	AI010114	155	AI020185	138	AI050152	143
AG010184B	77	AI010115	152	AI020186	155	AI050152A	143
AG010184C	77	AI010116	155	AI020201	138	AI050172	168
AG010184D	77	AI010121	152	AI020205	138	AI050175	142
AG010184E	77	AI010127	135	AI030002	140	AI050176	144
AG010184F	77	AI010136	156	AI030007	138	AI050191	144
AG010185	165	AI010137	135	AI030010	138	AI050192	144
AG010204	155	AI010139	152	AI030011	138	AI050200	156
AG010205	149	AI010153	167	AI030020	138	AI050201	158
AG010207	131	AI010166	135	AI030025	138	AI050202	143
AG010208	132	AI010167	135	AI030027	139	AI060006	144
AG010222	201	AI010176	135	AI030045	114	AI060020	144
AG010224	131	AI010195	135	AI030067	142	AI060030	145
AG010225	131	AI010201	139	AI030075	148	AI060030-A	145
AG010227	132	AI020015	135	AI040005	139	AI060030-B	145
AG010229	132	AI020019	135	AI040006	139	AI060030-C	145
AG010236	201	AI020020	135	AI040007	139	AI060030-D	145
AG010247	201	AI020021	135	AI040008	139	AI060030-E	145
AG1	Pág.	AI020024	135	AI040011	139	AI060030-F	145
AG10001SP	26	AI020025	135	AI040017	139	AI060031	145
AG10001SP-D	132	AI020027	135	AI040018	139	AI060031-A	145
AG10001SP-G	131	AI020043	136	AI040031	139	AI060031-B	145
AG10001SP-T	132	AI020047	135	AI040038	143	AI060031-C	145
AG10001SP-W	132	AI020048A	136	AI040060	139	AI060031-D	145
AG10002SC	38	AI020048D	136	AI040064	140	AI060031-E	145
AG10002SC-W	132	AI020048E	136	AI040245	167	AI060031-F	145
AH0	Pág.	AI020049	136	AI040246	140	AI060031-G	145
AH020002	132	AI020051	136	AI050001	142	AI060031-H	145
AIO	Pág.	AI020052	136	AI050004	140	AI060031-J	145
AI010006	132	AI020054	136	AI050004A	141	AI1	Pág.
AI010009	132	AI020056A	136	AI050008-10	142	AI10001SP	26
AI010017	133	AI020066	136	AI050009A	141	AI10002SP	26
AI010023	133	AI020074	129	AI050024	142	AI10003SP	27
AI010029	133	AI020092	103	AI050037	142	AL0	Pág.
AI010030	133	AI020101A	136	AI050040	142	AL010006	145
AI010033	143	AI020101A-A	136	AI050042	142	AL010011	145
AI010037	133	AI020103	137	AI050043	142	AL010029	158
AI010041	134	AI020107	137	AI050043S	138	AL010038	157
AI010060	133	AI020109	137	AI050071S	152	AL010041	156
AI010060-A	133	AI020113	155	AI050076	142	AL010044	153

AL010053A	158	AN010072	147	AN1	Pág.	BOUTJW04A-M	194
AL010057	156	AN010072C	148	AN100002SP	27	BOUTJW04A-XL	194
AL010070	154	AN010081A	147	ARO	Pág.	BOUTJW05A	194
AL010071	154	AN010085A	147	AR020016	203	BOUTJW06B	194
AL010072	158	AN010091A	148	AR020018	150	BOUTJW07A-L	194
AL010073	146	AN010092	148	AR020019	150	BOUTJW07A-M	194
AL010081	158	AN010102	146	AR020053A	150	BOUTJW07A-XL	194
AL010087	158	AN010106A	148	AR020060	203	BOUTJW07B-L	194
AL010088	158	AN010106A-C	148	AR020061	203	BOUTJW07B-M	194
AL010093	144	AN010112	148	AR030005	100	BOUTJW07B-XL	194
AL010099	152	AN010131	148	AR030013	150	BOUTJW08B-50	195
AL010113	167	AN010137	148	AR030022	94	BOUTJW08B-52	195
AL010114	167	AN010160	147	AR030034	150	BOUTJW08B-54	195
AL010116	167	AN010177B	151	AR030041	150	BOUTJW13A	195
AL010117	167	AN010186B	148	AR030047	150	BOUTJW14B	195
AL010128	152	AN010187	167	AR030058	94	BOUTJW15B	195
AL010175	154	AN010188A	148	AR030062	150	BOUTJW16A	195
AL010190	157	AN010188B	148	AR030067	203	BOUTJW17A-1	196
AL010196	153	AN010188C	148	AR040016	150	BOUTJW17A-2	196
AL010202	159	AN010202	158	AR040043	150	BOUTJW18A	196
AL010203	159	AN010202B	158	AR060002A	150	BOUTJW19A	196
AL010205	154	AN010225	148	AR060003	151	BOUTJW20A-L	196
AL010218	154	AN010226	149	AR060008	151	BOUTJW20A-M	196
AL010225	159	AN010235	168	AR060009	151	BOUTJW20A-XL	196
AL010282	155	AN010237	168	AR060010	151	BOUTJW21A-L	196
AL010291	159	AN010272	149	AR060011	147	BOUTJW21A-M	196
ANO	Pág.	AN010279	149	AR060020	151	BOUTJW21A-XL	196
AN010001	146	AN010293	146	AR060021	151	BOUTJW22A-L	196
AN010001C	146	AN010319	149	AR060024A	151	BOUTJW22A-M	196
AN010001D	146	AN010320	149	AR060029A	151	BOUTJW22A-XL	196
AN010001D-2	146	AN010321	146	AR060032	151	BOUTJW23A-L	196
AN010001D-3	146	AN010322	146	AR060038	151	BOUTJW23A-M	196
AN010001D-4	146	AN020007	149	AR060039A	151	BOUTJW23A-XL	196
AN010001D-5	146	AN020007-1	149	AR060043	151	BOUTJW24A	196
AN010001D-6	146	AN020022	149	AR060055	151	BOUTJW25B	196
AN010001D-7	146	AN020022-A	149	AR060056	151	BOUTJW26A	197
AN010001D-A	146	AN020022-B	149	AR060062	147	BOUTJW27A	197
AN010001D-E	146	AN020022-C	149	BS	Pág.	BOUTJW28A	197
AN010001D-F	146	AN020022-D	149	AS-0013	183	BOUTJW29A	197
AN010001D-K	146	AN040035A	149	AS-0013A2	183	C-1	Pág.
AN010001D-M	146	AN040043A	149	AS-0013C	183	C-10DW42	20
AN010001D-N	146	AN040055	168	AS-0015	183	C-13DW53	20
AN010009A	142	AN040056	168	AS-0015C	183	C-1DM1	19
AN010030	142	AN040062	168	AS-0049	183	C-3	Pág.
AN010033	147	AN040066	168	AS-0065	131	C-3DH1	21
AN010038	147	AN040082	104	BL	Pág.	C-3DH2	21
AN010045	126	AN040100	156	BLACK POWER 19	9	C-3DH262	21
AN010049	147	AN040101	149	BO	Pág.	C-3DH262V	21
AN010054A	147	AN040105	168	BOUTJW01A-L	194	C-3DH5	21
AN010054N	147	AN040126	156	BOUTJW01A-M	194	C-3DH6	21
AN010063	147	AN040168	150	BOUTJW01A-XL	194	C-3DW5	19
AN010065	147	AN040200	168	BOUTJW02A	194	C-4	Pág.
AN010066	147	AN040286	154	BOUTJW03B	194	C-4DWA1	19
AN010068	147	AN040327	148	BOUTJW04A-L	194	C-4DWA1G	19

C-6	Pág.	C-W	Pág.	D125H020A	105	D150MH1AD	107
C-6DA4	22	C-WHEEL1	23	D125H025A	105	D150MH1QD	107
C-6DA494	22	C-WHEEL2	23	D125H030A	105	D150P1A	105
C-6DWB1	19	C-WHEEL5	23	D125H040A	105	D150P2A	105
C-6DWB1G	19	C-WHEEL6	23	D125H050A	105	D150P3A	105
C-6DWB5	19	C-WHEEL8	23	D125H060A	105	D150T20A	106
C-7	Pág.	C-WHEEL9	23	D125H070A	105	D150T25A	106
C-7 TOWER	20	CF	Pág.	D125P1F	105	D150T27A	106
C-7DC2B	19	CF-K-C	185	D125P2F	105	D150T30A	106
C-7DS1	19	CF-K-E	185	D125P3F	105	D150T40A	106
C-7DW1-TS	22	CF-K-E	185	D125T06A	105	D150Z1A	105
C-7DW9	20	CF-K-F	185	D125T08A	105	D150Z2A	105
C-A	Pág.	CF-K-G	185	D125T10A	105	D150Z3A	105
C-A10	23	CF-K-I	185	D125T15A	105	D16	Pág.
C-A11	23	CF-K-J	185	D125T20A	105	D160MH1QD	107
C-A12	23	CH	Pág.	D125T25A	105	D165MN06M	107
C-A13	23	CHAPEIRO20- BLACK	15	D125T27A	105	D165MN07M	107
C-A16W	20	CHAPEIRO20-C	15	D125T30A	105	D165MN08M	107
C-A17W	20	CHAPEIRO20-V	15	D125T40A	105	D165MN10M	107
C-A17WG	20	CHAPEIROALU-BLACK	16	D125TT08A	106	D165MN12M	107
C-A2501S	23	CHAPEIROALU-C	16	D125TT10A	106	D165MN13M	107
C-A27	22	CHAPEIROALU-V	16	D125TT15A	106	D17	Pág.
C-A3	22	D04P	Pág.	D125TT20A	106	D175H100	106
C-A3-B	22	D04P180	99	D125TT25A	106	D175H120	106
C-A31	22	D04P2100	99	D125TT27A	106	D175H40	106
C-A3G	22	D04P3150	99	D125TT30A	106	D175H50	106
C-A456	22	D04S	Pág.	D125TT35A	106	D175H60	106
C-A7	23	D04S480	99	D125TT40A	106	D175H70	106
C-A8	23	D04S5125	99	D125Z1A	105	D175H80	106
C-A9	22	D04S6100	99	D125Z2A	105	D175T20	106
C-APB	23	D04S6150	99	D125Z3A	105	D175T25	106
C-B	Pág.	D10	Pág.	D13	Pág.	D175T30	106
C-B5	23	D100MN08M	106	D130H100	105	D175T40	106
C-BS Kit1	23	D100MN10M	106	D130H120	105	D175T45	106
C-BS Kit2	23	D100MN12M	106	D130H40	105	D175T50	106
C-BS Kit3	23	D100MN13M	106	D130H50	105	D175T55	106
C-BS Kit6	23	D100MN14M	106	D130H60	105	D37	Pág.
C-D	Pág.	D10M30M05A	106	D130H70	105	D3750P0	102
C-DBU1	203	D10M30M06A	106	D130H80	105	D3750P00	102
C-DBU7	203	D10M30M08A	106	D130T20	105	D3750P08S	101
C-DM1	131	D10M30M10A	106	D130T25	105	D3750P1	102
C-DMH212	74	D10M30M12A	106	D130T30	105	D3750S10	102
C-DMH314	74	D10M30M14A	106	D130T40	105	D3750S16	102
C-DMH414	74	D10M75M05A	106	D130T45	105	D3750S20	102
C-DS14	197	D10M75M06A	106	D130T50	105	D3750S24	102
C-DSP	197	D10M75M08A	106	D130T55	105	D3750S30	102
C-DSP-0WB10	197	D10M75M10A	106	D15	Pág.	D3750T08S	101
C-P	Pág.	D10M75M12A	106	D150F5510A	105	D3750T10	102
C-PC1	23	D10M75M14A	106	D150F6512A	105	D3750T15	102
C-PC2	23	D100N	Pág.	D150F8012A	105	D3750T18S	102
C-PC3	23	D100N13M	106	D150H030A	106	D3750T20	102
C-PC4	23	D12	Pág.	D150H040A	106	D3750T5	102
C-T	Pág.	D125F4506A	105	D150H050A	106	D3750T6	102
C-T12	22	D125F6512A	105	D150H060B	106	D3750T7	102
C-T4A	203	D125F8016A	105	D150H070B	106		
C-T5G-DP	203	D125H015A	105	D150H080B	106		

D3750T8	102	D71PP08SP	27	D725N11	100	F	Pág.
D3750T9	102	D71PP16S	101	D725N12	100	FITA JW	197
D376514SC	38	D71S10250	98	D725N13	100	GM	Pág.
D70	Pág.	D71S250	98	D73	Pág.	GM-02AF	191
D70105KV	34	D71S360	98	D737128SV	32	GM-02AH	191
D70105SP	27	D71S4100	98	D737134SV	32	GM-02AM	191
D70P175	97	D71S4150	98	DBT	Pág.	GM-02BH	191
D70P2100	97	D71S4200	98	DBT31B	102	GM-02BPH	191
D70P3125	97	D71S480	98	DBT53A	103	GM-02PF	191
D70P3150	97	D71S5125	98	DR0	Pág.	GM-02PH	191
D70PP07S	100	D71S5200	98	DR0107S	102	GM-02PM	191
D70PP10S	100	D71S5300	98	DR0119S	102	GM-03AF	191
D70PS119KV	34	D71S5300	98	DR0253S	102	GM-03AH	191
D70S475	97	D71S538	98	DR04	102	GM-03AM	191
D70S5100	97	D71S575	98	DS9	Pág.	GM-03PF	191
D70S6125	97	D71S6100	98	DS96	197	GM-03PH	191
D70S6150	97	D71S6150	98	DV1	Pág.	GM-03PM	191
D70S8150	97	D71S638	98	DV13P060	117	GM-04AF	191
D70S8175	97	D71S6400	98	DV13P180	117	GM-04AH	191
D70S9175	97	D71S8150	98	DV13P2100	117	GM-04AM	191
D70S9250	97	D71S8200	98	DV13P3150	117	GM-04PF	191
D71	Pág.	D71S8300	98	DV13PP07S	118	GM-04PH	191
D71157SV	32	D71S8500	98	DV13S275	117	GM-04PM	191
D71400T10	100	D71S9175	98	DV13S3100	117	H01	Pág.
D71400T15	100	D71T10	99	DV13S4100	117	H01B1015	107
D71400T20	100	D71T107S	101	DV13S5125	117	H01B1020	107
D71400T25	100	D71T109S	101	DV13S6150	117	H01B1025	107
D71400T27	100	D71T15	99	DV13S8175	117	H01B1030	107
D71400T30	100	D71T20	99	DV13Z060	117	H01B1035	107
D715N05	99	D71T25	99	DV13Z180	117	H01B1040	107
D715N07	99	D71T27	99	DV13Z2100	117	H01B1045	107
D715N08	99	D71T30	99	DV13Z3150	117	H01B1050	107
D715N10	99	D71T40	99	DV15109S	118	H01B1055	107
D715N12	99	D71T45	99	DV15PP-TP	100	H01B1060	107
D715N13	99	D71T5	99	DV4	Pág.	H01B1070	107
D71C105S	100	D71T50	99	DV4118SV	118	H01B1080	107
D71C106S	100	D71T6	99	DV41M06S	118	H01B1090	107
D71P060	98	D71T7	99	DV41M10	118	H01B1100	107
D71P1100	98	D71T8	99	DV41M13	118	H01B1120	107
D71P1150	98	D71T9	99	DV41M5	118	H01B1140	107
D71P1300	98	D71Z060	99	DV41M6	118	H01B1160	107
D71P138	98	D71Z105S	101	DV41M7	118	H01B1170	107
D71P180	98	D71Z107S	101	DV41M8	118	H01B1180	107
D71P2100	98	D71Z138	99	EL	Pág.	H01B1190	107
D71P2150	98	D71Z180	99	ELECTR-BLACK	14	H01B1220	107
D71P2150	98	D71Z2100	99	ELECTR-C	14	H01MH118S	107
D71P2250	98	D71Z3150	99	ELECTR-V	14	H01SA109S	107
D71P238	98	D71Z4200	99	ELECTR. 1000 BLACK	12	H01SA1100	108
D71P2400	98	D72	Pág.	ELECTR. 1000-C	12	H01SA115	108
D71P3150	98	D725N06	100	ELECTR. 1000-V	12	H01SA120	108
D71P3250	98	D725N07	100	EV	Pág.	H01SA125	108
D71P3400	98	D725N08	100	EVA POWER BLACK	7	H01SA130	108
D71P4200	98	D725N08SP	27	EVA POWER-C	7	H01SA140	108
D71PP08KV	35	D725N09	100	EVA POWER-V	7	H01SA150	108
D71PP08S	100	D725N10	100				

H01SA160	108	H08ST20115	110	H20MT27	108	JA-6111(1.4)	181
H01SA180	108	H08ST25130	110	H20MT30	108	JA-6111K	182
H01SM109S	107	H08ST27145	110	H20MT40	108	JA-7253	189
H02	Pág.	H08ST30165	110	H20MT45	108	JA-7254	189
H02MH217S	107	H08ST40185	110	H20MT50	108	JA-950	183
H02SM109S	107	H08ST45205	110	H22	Pág.	JA-950-04	183
H02SM209S	107	H08ST50230	110	H22S109S	111	JA-960	183
H03	Pág.	H10	Pág.	HC	Pág.	JA-C131SV	32
H03MH118S	109	H10121SV	32	HC-100/15	141	JA-HVLP-1080GD-N1.4	182
H03SM109S	109	H10MB08KV	35	HC-106/15	141	JA-HVLP-1080GK	182
H03SS109S	109	H10MB08S	110	HC-108/15	141	JA-HVLP-3000-NS17	182
H05	Pág.	H10MB08SP	27	HC-108/18	141	JA-HVLP-3000-NS19	182
H05SA109S	109	H10MB10200	110	HC-65/14	141	JA-HVLP-300C (1.3)	182
H05SS109S	109	H10MB2100	110	HC-65/67	141	JA-HVLP-6112	182
H06	Pág.	H10MB25100	110	HC-65103	141	JA-LVLP-0303W	182
H06SA109S	109	H10MB3100	110	HC-66/6	141	JA-LVLP-0303W-N	182
H06SA1100	108	H10MB4100	110	HC-68/14	141	JA-LVLP-0303W-N18	182
H06SA115	108	H10MB5150	110	HC-73/14	141	JAB	Pág.
H06SA120	108	H10MB6150	110	HC-74/15	141	JAB-1017	176
H06SA125	108	H10MB8200	110	HC-74/76	141	JAB-1017-RK	176
H06SA130	108	H10MT08KV	35	HC-75/77	141	JAB-1018	176
H06SA140	108	H10MT08SP	27	HC-76/12	141	JAB-1018-RK	177
H06SA150	108	H10MT09S	110	HC-76/14	141	JAB-7003A	177
H06SA160	108	H10MT10100	110	HC-76/30	141	JAB-7003A-RK	177
H06SA180	108	H10MT15100	110	HC-76/8	141	JAD	Pág.
H06SM209S	109	H10MT20100	110	HC-78/15	141	JAD-0212	175
H06SM2100	109	H10MT25100	110	HC-80/15	141	JAD-0212-RK	175
H06SM225	109	H10MT27150	110	HC-80/82	141	JAD-0413	175
H06SM230	109	H10MT30150	110	HC-86/16	141	JAD-0413-RK	175
H06SM240	109	H10MT40150	110	HC-86/18	141	JAD-0534	175
H06SM250	109	H10MT45200	110	HC-9.5mm	141	JAD-0534-RK	175
H06SM255	109	H10MT50200	110	HC-90/15	141	JAD-1015-RK	177
H06SM260	109	H12	Pág.	HC-92/10	141	JAD-1015K	177
H06SM280	109	H12S09085	108	HC-93/15	141	JAD-1020	176
H06ST108S	109	H12S10090	108	HC-93/36	141	JAD-1020-RK	176
H06W106S	109	H12S110S	110	HC-93/45	141	JAD-1021	176
H07	Pág.	H12S15100	108	HC-95/15	141	JAD-1021-RK	176
H07M09S	109	H12S20115	108	HC-96/18	141	JAD-1027	176
H07MT10	109	H12S25130	108	HV	Pág.	JAD-1027-RK	176
H07MT15	109	H12S27145	108	HV1000V-BLACK	13	JAD-6249	176
H07MT20	109	H12S30165	108	HV1000V-C	13	JAD-6252A	176
H07MT25	109	H12S40185	108	HV1000V-V	13	JAD-6252A-RK	176
H07MT27	109	H12S45205	108	JA	Pág.	JAG	Pág.
H07MT30	109	H12S50230	108	JA-0001RK	183	JAG-0903-MS	177
H07MT40	109	H15	Pág.	JA-300C-28	183	JAG-0906R/RM-RK	177
H07MT45	109	H15M105S	111	JA-300C-NS13	182	JAG-0906RMK	177
H07MT50	109	H20	Pág.	JA-3806C	183	JAG-0913RM-RK	178
H08	Pág.	H20MB1037S	111	JA-3808A	183	JAG-0913RMK	177
H0816S	110	H20MT08SP	27	JA-3812A	188	JAG-0923RM	178
H08MTP09S	110	H20MT09S	111	JA-3812D	188	JAG-0923RM-RK	178
H08S110S	110	H20MT10	108	JA-5032	188	JAG-0925RM	178
H08ST09085	110	H20MT15	108	JA-6111-NS13	182	JAG-0925RM-RK	178
H08ST10090	110	H20MT20	108	JA-6111-NS17	182	JAG-0955RM	178
H08ST15100	110	H20MT25	108	JA-6111-NS20	182	JAG-0955RM-RK	178

JAG-1087	178	JAI-6202-RK	174	JAS-6542-RK	184	JAT-6613-PA	185
JAG-1087-RK	178	JAI-6211	172	JAS-6543	184	JAT-6613-RK	185
JAG-6638	178	JAI-6211-RK	172	JAS-6543-RK	184	JAT-6673	188
JAG-6638-RK	178	JAI-6212-RK1	172	JAS-6551	179	JAT-6673-RK	188
JAG-6639	178	JAI-6212K	172	JAS-6551-RK	179	JAT-6676	185
JAG-6639-RK	179	JAR	Pág.	JAS-6552	179	JAT-6676-RK	185
JAH	Pág.	JAR-1012	174	JAS-6552-RK	179	JAT-6904S	189
JAH-0288	187	JAR-1012-RK	174	JAT	Pág.	JAT-6905-C	189
JAH-0288-15	187	JAR-1013	174	JAT-1011	184	JAT-6905-J	189
JAH-0288-16	187	JAR-1013-RK	174	JAT-1011-RK	184	JAT-6905B	189
JAH-0288-17	187	JAR-1033	175	JAT-1020-RK	184	JAT-6905S	189
JAH-0288-RK	187	JAR-1033-RK	175	JAT-1020K	184	JAT-6943A	186
JAH-308HK	187	JAR-1094	174	JAT-1035	188	JAT-6943A-RK	186
JAH-308H-RK	187	JAR-1094-RK	174	JAT-1035-RK	188	JAT-6952	186
JAH-6837	187	JAR-6309A-RK	174	JAT-1041	184	JAT-6952-RK	186
JAH-6837-50	187	JAR-6309AK	174	JAT-1041-16S	184	JAT-6952P	186
JAH-6837-50-2	187	JAR-6310A	174	JAT-10T18	185	JAT-6952P-37	186
JAH-6837-RK	187	JAR-6310A-RK	175	JAT-10T32	185	JAT-6952P-39	186
JAH-7104H	187	JAR-6310AK	175	JAT-12F1	184	JAT-6952P-40	186
JAH-7104H-RK	187	JAS	Pág.	JAT-12F2	184	JAT-6952P-RK	186
JAI	Pág.	JAS-0010	179	JAT-12F3	184	JAT-6959	189
JAI-0501-RK	174	JAS-0010-41	179	JAT-12F4	184	JAT-6959A	189
JAI-0926-RK	172	JAS-0010-RK	179	JAT-20T14	184	JAZ	Pág.
JAI-0936	172	JAS-0413	179	JAT-20T18	184	JAZ-0001B	189
JAI-0936-RK	172	JAS-0413-RK	179	JAT-20T24	184	JAZ-0002A	189
JAI-0938	173	JAS-0423-31	180	JAT-460	188	JAZ-0002B	189
JAI-0938-RK	173	JAS-0423-RK	180	JAT-480-NS	188	JAZ-0002C	189
JAI-0954	171	JAS-0423K	180	JAT-481	188	JAZ-0042	189
JAI-0954-RK	171	JAS-0452	183	JAT-501	188	JAZ-011H	187
JAI-1024	170	JAS-0452-RK	184	JAT-6004K	188	JAZ-016H	187
JAI-1024-RK	170	JAS-1021-6HE-RK	180	JAT-6034	187	JAZ-0512	190
JAI-1054	171	JAS-1021-6HE(2.5)	180	JAT-6034-1A	187	JAZ-0513	190
JAI-1054-RK	171	JAS-1031-6HE	181	JAT-6034-1B	187	JAZ-0513-09	189
JAI-1114	170	JAS-1031-6HE-RK	181	JAT-6034-1C	187	JAZ-0513-50	189
JAI-1114-RK	170	JAS-1031-6HP	181	JAT-6034-1D	187	JAZ-0514	190
JAI-1114K	170	JAS-1031-6HP	181	JAT-6034-RK	187	JAZ-0514-06	189
JAI-1124	170	JAS-1206-6HE	180	JAT-6412	186	JAZ-0514-09	189
JAI-1124-RK	170	JAS-1206-6HE-RK	180	JAT-6412-RK	186	JAZ-0514-13	189
JAI-1138	173	JAS-1206-6HP	180	JAT-6421	185	JAZ-0514-48	189
JAI-1138-RK	173	JAS-1207-6HE	180	JAT-6421-33	185	JAZ-0516	190
JAI-1138L	173	JAS-1207-6HE-56	180	JAT-6421-RK	185	JAZ-3811E	188
JAI-1206L	172	JAS-1207-6HE-57	181	JAT-6441-RK	185	JAZ-39520	189
JAI-1206L-RK	173	JAS-1207-6HE-RK	180	JAT-6441K	185	JAZ-6704-O	191
JAI-1232-RK	171	JAS-6505	179	JAT-6443-K1	186	JAZ-6704-W	191
JAI-1232K	171	JAS-6505-RK	179	JAT-6443-K2	186	JAZ-6704A	190
JAI-1408	173	JAS-6531	181	JAT-6443-K3	186	JAZ-6710A	191
JAI-1408-RK	173	JAS-6531-RK	181	JAT-6443-K4	186	JAZ-6711A	191
JAI-1408L	173	JAS-6535-5HE	181	JAT-6443-K5	186	JAZ-6712A	191
JAI-1513	171	JAS-6535-5HE-47	181	JAT-6443-K6	186	JAZ-6715A	191
JAI-1513-RK	171	JAS-6535-5HE-RK	181	JAT-6443-K7	186	JAZ-7207	177
JAI-1514	172	JAS-6535-5VE-RK	181	JAT-6443-RK	186	JAZ-7214F	191
JAI-1514-RK	172	JAS-6535-6HE	181	JAT-6443K	186	JAZ-7214S	191
JAI-1524	170	JAS-6535-6HE-RK	181	JAT-6613	185	JAZ-7214Z	191
JAI-1524-RK	171	JAS-6542	184	JAT-6613-P	185	JAZ-ST4	197

JW	Pág.	M2950-T1	112	ME020001	160	MK2	Pág.
JW-01B	194	M2950-T2	112	ME020002	160	MK2040	115
JW-BACKPACK	195	M60	Pág.	ME020003	160	MK2040-B	115
JW-KEYRING02	195	M60103	113	ME020005	160	MK2080	115
JW-KEYRING03	195	M60104	113	ME020006	160	MKS	Pág.
JW-OPENER	197	M60105	113	MEC	Pág.	MKS27	115
JW-USB1	195	M61	Pág.	MEC PESADOS 20A	18	MKS27-12	115
K	Pág.	M61110	113	MEC PESADOS 20B	18	MKS27-16	115
KIT AR	191	M61112	113	MEC POLEGADAS	10	MKS27-16A	115
M01	Pág.	M61113	113	MEC POWER 19C	9	MKS27-20	115
M01016	112	M61116	113	MEC POWER 19V	9	MKS27-SK2	115
M01020	112	M61119	113	MEC PROF20-BLACK	11	MKV	Pág.
M03	Pág.	M61122	113	MEC PROF20-C	11	MKV7	118
M03025	112	M61125	113	MEC PROF20-V	11	MKV7-K	118
M04	Pág.	M61H116	114	MEC SOLUTION BLACK	8	MKV8	118
M04008	112	M61H119	114	MEC SOLUTION-C	8	MNO	Pág.
M04012	112	M61H124	114	MEC SOLUTION-V	8	MN020004	161
M04016	112	M62	Pág.	MFO	Pág.	MN020005	161
M04024	112	M62102	113	MF05A	115	MSH	Pág.
M04032	112	M62103	113	MF05B	115	MSH1214	74
M05	Pág.	M62104	113	MF05C	115	MSH1414	74
M05020	112	M62105	113	MF05D	115	MSH3814	74
M06	Pág.	M62106	113	MF05E	115	MT0	Pág.
M06030	112	M62108	113	MF05S	115	MT010001	161
M06040	112	M62H102	114	MFM	Pág.	MT010002	161
M07	Pág.	M62H103	114	MFM06S	115	MT010003	162
M07016	112	M62H104	114	MG0	Pág.	MT010004	162
M07016-ACE	112	M62H106	114	MG010001	160	MT010005	162
M07016-TPR	112	M63	Pág.	MG010002	160	MT010006	162
M09	Pág.	M63102	113	MG010003	160	MT010007	162
M09100	112	M63103	113	MG010005	160	MT010008	162
M091000	112	M63104	113	MG010006	160	MT0901	115
M09103KV	35	M63105	113	MG010008	160	MT0902	115
M09200	112	M63106	113	MG010009	160	MTC	Pág.
M09300	112	M63106S	114	MG020001	160	MTC101SP	28
M09500	112	M63108	113	MG020003	160	MTC1150	116
M09513SP	28	M63113KV	35	MG020006	160	MTC1200	116
M09800	112	M63H103	114	MG020007	160	MTC1300	116
M10	Pág.	M63H105	114	MG020008	161	MTC150	116
M10110	165	M63H106	114	MHS	Pág.	MTC153	116
M10210A	165	M63H108	114	MHS08KV	35	MTC155	116
M10210B	165	M63M106S	114	MHS100AG	115	MTC156	116
M10410A	165	M64	Pág.	MHS300	115	MTC200	116
M10410B	165	M64105	113	MI1	Pág.	MTC306	116
M11	Pág.	M64105S	114	MI010014	161	MTC308	116
M11035	112	M645114SP	28	MI010016	161	MTC408	116
M11045	112	M64A155	114	MI010017	161	MTC508	116
M11065	112	M64M105S	114	MI010018	161	MTM	Pág.
M29	Pág.	ME0	Pág.	MI010019	161	MTM1025	116
M2927-T2	112	ME010001	159	MI010020	161	MTM1050	116
M2932	112	ME010007	159	MI010021	161	MTM1075	116
M2932-T1	112	ME010009	159	MI020001	161	MTM1100	116
M2932-T2	112	ME010010	159	MI020002	161		
M2940-T2	112	ME010012	159	MI020004	161		

P-B	Pág.	P-TR(S04H3157SP)	41	P14	Pág.	P36M06C	96
P-B (31)	41	P-TR(S04H3536SP)	41	P1416	91	P36M09A	94
P-B (41)	41	P-TR(S04H4125SP)	41	P15	Pág.	P36M09C	96
P-E	Pág.	P-TR(S04H4524SP)	41	P1516	91	P37	Pág.
P-EVA(D70105KV)	39	P-TR(S04H4726SP)	41	P15808	92	P37M11A	95
P-EVA(D71PP08KV)	39	P-TR(S04H4728SP)	41	P16	Pág.	P37M18A	95
P-EVA(D737128SV)	39	P-TR(S06H4275SP)	41	P16507	88	P38	Pág.
P-EVA(D737134SV)	39	P-TR(S09H4118SP)	41	P16509	88	P38M09A	95
P-EVA(H10121SV)	39	P-TR(S29H4140SP)	41	P16517	88	P38M11A	95
P-EVA(H10MB08KV)	39	P-TR(W23108SP)	41	P16519	88	P40	Pág.
P-EVA(H10MT08KV)	39	P-TR(W25110SP)	41	P16527	88	P4016	91
P-EVA(M09103KV)	39	P-TR(W26112SP)	41	P16529	88	P43	Pág.
P-EVA(M63113KV)	39	P-TR(W26116SP)	41	P16537	88	P4318	92
P-EVA(MHS08KV)	39	P01	Pág.	P16539	88	P4318-RK	92
P-EVA(P011804KV)	39	P0118	91	P17	Pág.	P4330	92
P-EVA(P32M105KV)	39	P011804KV	35	P178	92	P4330-RK	92
P-EVA(P82714SV)	39	P018	88	P18	Pág.	P52	Pág.
P-EVA(P82736SV)	39	P018SP	28	P1810	92	P52A10	95
P-EVA(P82736SV)	39	P018SP1	28	P20	Pág.	P52B10	95
P-EVA(S03A4122KV)	40	P03	Pág.	P2010LA	92	P52C10	95
P-EVA(S04H2132KV)	40	P038	88	P2010RA	92	P52D12	95
P-EVA(S04H4144KV)	40	P04	Pág.	P2010SA	92	P52M10	95
P-EVA(S04H42165SV)	40	P046	88	P22	Pág.	P52N10	95
P-EVA(S04H4295SV)	40	P04704SP	28	P2205E	92	P53	Pág.
P-EVA(S04H45121SV)	40	P05	Pág.	P2208A	92	P53M06	95
P-EVA(S07H2138KV)	40	P0516	91	P2212A	92	P53M11	95
P-EVA(S29H4141KV)	40	P0518	91	P26	Pág.	P53M18	95
P-EVA(W23559SV)	40	P06	Pág.	P266	90	P54	Pág.
P-EVA(W25110KV)	40	P068	88	P27	Pág.	P54M08A	95
P-EVA(W26116KV)	40	P068A	88	P2706	88	P54M10A	95
P-EVA(W26134SV)	40	P07	Pág.	P2710	88	P60	Pág.
P-EVA(W2623431SV)	40	P079	88	P2710SP	28	P6008	88
P-T	Pág.	P08	Pág.	P2712	88	P61	Pág.
P-TR (D70SP06ST)	41	P0803SP	28	P28	Pág.	P6106	88
P-TR (PC303ST)	41	P08104S	92	P2803SP	29	P6108	88
P-TR (S04H4120ST)	41	P0813SC	38	P2810	88	P6118	91
P-TR (S04H4506ST)	41	P0816	91	P28110	91	P64	Pág.
P-TR (W26107ST)	41	P0817	91	P28112	91	P6424	93
P-TR (W26920ST)	41	P0818	91	P28210	91	P71	Pág.
P-TR(AG010002SP)	41	P09	Pág.	P28212	91	P7101	90
P-TR(AG010026SP)	41	P0903SP	28	P30	Pág.	P7102	90
P-TR(AI10002SP)	41	P0916	91	P30M07C	95	P7103	90
P-TR(D70105SP)	41	P0917	91	P30M10A	94	P7104	90
P-TR(D71PP08SP)	41	P0918	91	P32	Pág.	P7105	90
P-TR(H10MB08SP)	41	P10	Pág.	P32M03S	96	P76	Pág.
P-TR(M09513SP)	41	P1016	91	P32M05C	95	P7601	93
P-TR(M645114SP)	41	P1017	91	P32M07A	94	P7602	93
P-TR(P018SP)	41	P1019	95	P32M105KV	36	P7603	93
P-TR(P04704SP)	41	P11	Pág.	P32M10A	94	P7608	93
P-TR(P0803SP)	41	P1116	91	P32M10C	95	P77	Pág.
P-TR(P0903SP)	41	P1118	91	P36	Pág.	P7719	93
P-TR(P2710SP)	41	P12	Pág.	P36M01P	94	P78	Pág.
P-TR(S03A4122SP)	41	P1216	91	P36M02P	94	P7801	96
P-TR(S04H2125SP)	41	P1218	91				

P7802	96	PV1416	119	R45	Pág.	RV0	Pág.
P7803	96	PV1516	119	R4502	45	RV032	117
P7804	96	PV2	Pág.	R4502JRK	46	RV033	117
P7805	96	PV28110	119	R4502RK	46	RV034	117
P78M10C	96	PV4	Pág.	R46	Pág.	S01U	Pág.
P80	Pág.	PV4006	119	R4602	45	S01U4108S	78
P8006	90	R12	Pág.	R4603	45	S01U4113	78
P81	Pág.	R1206N	43	R4604	45	S01U4114	78
P8106	90	R1206N-R	46	R48	Pág.	S01U4115	78
P82	Pág.	R1206R	46	R4802	45	S01U4116	78
P82714SV	32	R12081	43	R4802A	45	S01U4117	78
P82736SV	33	R12081RK	46	R4802B	45	S01U4119	78
P86	Pág.	R19	Pág.	R4802RK	46	S01U4121	78
P8606	89	R19H310S	78	R4803	45	S01U4122	78
P90	Pág.	R19H3110	78	R4804	45	S03A	Pág.
P9006	89	R19H3111	78	R4804A	45	S03A2110	79
P94	Pág.	R19H3112	78	R4804B	45	S03A2112	79
P9409	95	R19H3113	78	R4804RK	46	S03A2114	79
P95	Pág.	R19H3114	78	R4811SC	38	S03A2UT	79
P9506	89	R19H3115	78	R51	Pág.	S03A3UT	79
P9508C	89	R19H3116	78	R5103	45	S03A4109	80
P9508D	89	R19H3117	78	R5103RK	46	S03A4110	80
P9512	89	R19H3118	78	R5104	45	S03A4111	80
P96	Pág.	R19H3119	78	R5104RK	46	S03A4111S	78
P9601	115	R29	Pág.	R53	Pág.	S03A4112	80
P98	Pág.	R2902	44	R53A-2A	78	S03A4113	80
P9806A	89	R2902RK	46	R53A-3A	78	S03A4114	80
P99	Pág.	R2903RK	46	R53A-4A	78	S03A4115	80
P9902S	90	R2904	44	R58	Pág.	S03A4116	80
P9920-BT	90	R2904RK	46	R5802ERK	46	S03A4117	80
P9920-ST	90	R34	Pág.	R5803RK	46	S03A4118	80
PES	Pág.	R3402RK	46	R5804ERK	46	S03A4119	80
PESD05	92	R3403	44	R5804LRK	46	S03A4120	80
PESD10	92	R3403RK	46	R66	Pág.	S03A4121	80
PESD11	92	R3404RK	46	R6602	45	S03A4122	80
PIN	Pág.	R35	Pág.	R6603	45	S03A4122KV	36
PINTOR20-BLACK	17	R3502	44	R6604	45	S03A4122SP	29
PINTOR20-C	17	R3503	44	R68	Pág.	S03A4123	80
PINTOR20-V	17	R3504	44	R6802	45	S03A4124	80
PSV	Pág.	R36	Pág.	R6802RK	46	S03A4127	80
PSV110SC	119	R3602	44	R6803	45	S03A4129	80
PSV218SP	119	R3602RK	46	R6803RK	46	S03A4130	80
PV0	Pág.	R3603	44	R6804	45	S03A4132	80
PV0118	118	R3603RK	46	R6804RK	46	S03A4211S	79
PV0518	119	R3604RK	46	R70	Pág.	S03A4A3	79
PV0816	118	R37	Pág.	R7012	76	S03A4A6	79
PV0817	118	R3702	44	R7013	76	S03A4E4	79
PV0918	119	R3702B	44	RD0	Pág.	S03A4E5	79
PV1	Pág.	R3703	44	RD01	45	S03A4E6	79
PV1016	119	R3704	44	RD01032S	103	S03A4E8	79
PV1116	119	R3704B	44	RD02	45	S03A4U4	79
PV1118	119	R41	Pág.	RD05H2	103	S03A4UT	79
PV1218	119	R4103	44	RD0638S	103	S03A4UT	79
		R4104	44				

S03A4UT3S	79	S03A8135	83	S03AD4321	86	S03S	Pág.
S03A6108S	79	S03A8136	83	S03AD4414S	79	S03SD8117	85
S03A6126	82	S03A8138	83	S03AD4517	87	S03SD8119	85
S03A6127	82	S03A8140	83	S03AD4519	87	S03SD8121	85
S03A6129	82	S03A8141	83	S03AD4521	87	S03V	Pág.
S03A6130	82	S03A8144	83	S03AD6107S	80	S03V2106	119
S03A6132	82	S03A8146	83	S03AD6120S	80	S03V2108	119
S03A6133	82	S03A8150	83	S03AD6124	81	S03V2110	119
S03A6134	82	S03A8155	83	S03AD6126	81	S03V2114	119
S03A6135	82	S03A8160	83	S03AD6127	81	S03V3108	120
S03A6136	82	S03A8165	83	S03AD6129	81	S03V3110	120
S03A6137	82	S03A8170	83	S03AD6130	81	S03V3112	120
S03A6138	82	S03A8173	83	S03AD6132	81	S03V3113	120
S03A6139	82	S03A8175	83	S03AD6133	81	S03V3114	120
S03A6140	82	S03A8176	83	S03AD6134	81	S03V3116SC	120
S03A6141	82	S03A8178	83	S03AD6135	81	S03V3117	120
S03A6142	82	S03A8180	83	S03AD6136	81	S03V3119	120
S03A6143	82	S03A8185	83	S03AD6138	81	S03V3122	120
S03A6144	82	S03A8185	83	S03AD6140	81	S03V3136SV	120
S03A6145	82	S03A8189	83	S03AD6141	81	S03V4110	120
S03A6146	82	S03A8190	83	S03AD6142	81	S03V4111	120
S03A6147	82	S03A8192	83	S03AD6144	81	S03V4112	120
S03A6148	82	S03A8195	83	S03AD6146	81	S03V4113	120
S03A6149	82	S03A8A6	84	S03AD6150	81	S03V4114	120
S03A6150	82	S03A8E04	84	S03AD6150	81	S03V4117	120
S03A6151	82	S03A8E07	84	S03AD8107S	85	S03V4119	120
S03A6152	82	S03A8E10	84	S03AD8117	84	S03V4120SC	120
S03A6153	82	S03AD	Pág.	S03AD8117	84	S03V4122	120
S03A6154	82	S03AD4110	81	S03AD8124	84	S03V4124	120
S03A6155	82	S03AD4111	81	S03AD8126	84	S03V4124SV	120
S03A6156	82	S03AD4111S	79	S03AD8127	84	S03V4127	120
S03A6157	82	S03AD4112	81	S03AD8129	84	S03V4132	120
S03A6158	82	S03AD4115	81	S03AD8130	84	S04H	Pág.
S03A6159	82	S03AD4117	81	S03AD8132	84	S04H2104	61
S03A6160	82	S03AD4118	81	S03AD8133	84	S04H21045	61
S03A6163	82	S03AD4119	81	S03AD8134	84	S04H2105	61
S03A6165	82	S03AD4120	81	S03AD8136	84	S04H21055	61
S03A6167	82	S03AD4121	81	S03AD8138	84	S04H2106	61
S03A6170	82	S03AD4122	81	S03AD8140	84	S04H2107	61
S03A6A4	84	S03AD4124	81	S03AD8141	84	S04H2108	61
S03A6A8	84	S03AD4125	81	S03AD8142	84	S04H2109	61
S03A6E04	84	S03AD4126	81	S03AD8146	84	S04H2110	61
S03A6E08	84	S03AD4127	81	S03AD8148	84	S04H2111	61
S03A6E10	84	S03AD4128	81	S03AD8150	84	S04H2112	61
S03A6U6	84	S03AD4130	81	S03AD8155	84	S04H2113	61
S03A8109S	84	S03AD4132	81	S03AD8158	84	S04H2114	61
S03A8124	83	S03AD4303S	86	S03AD8160	84	S04H2118S	56
S03A8127	83	S03AD4307S	86	S03AD8165	84	S04H2125SP	29
S03A8129	83	S03AD4317	86	S03H	Pág.	S04H2132KV	36
S03A8130	83	S03AD4319	86	S03H2327S	56	S04H2141S	56
S03A8132	83			S03H2353S	56	S03S	Pág.
S03A8133	83			S03S	Pág.	S03S8117	85
S03A8134	83			S03S8117	85	S03S8119	85
				S03S8121	85	S03S8121	85
						S04H3106	61
						S04H3107	61
						S04H3108	61

S04H3109	61	S04H4524S	57	S04H6426	64	S04HD4119	63
S04H3110	61	S04H4524SP	30	S04H6427	64	S04HD411S	66
S04H3111	61	S04H46121SV	34	S04H6429	64	S04HD4120	63
S04H3112	61	S04H4726SP	30	S04H6430	64	S04HD4121	63
S04H3113	61	S04H4728S	57	S04H6432	64	S04HD4122	63
S04H3114	61	S04H4728SP	30	S04H6433	64	S04HD4123	63
S04H3115	61	S04H5129SC	38	S04H6435	64	S04HD4124	63
S04H3116	61	S04H524127S	60	S04H6436	64	S04HD4125	63
S04H3117	61	S04H52460S	59	S04H6438	64	S04HD4126	63
S04H3118	61	S04H52477S	59	S04H6440	64	S04HD4127	63
S04H3119	61	S04H52478S	59	S04H6441	64	S04HD4128	63
S04H3120	61	S04H6115S	57	S04H6443	64	S04HD4130	63
S04H3121	61	S04H6119	63	S04H6444	64	S04HD4132	63
S04H3122	61	S04H6121	63	S04H6446	64	S05A	Pág.
S04H3124	61	S04H6122	63	S04H6447	64	S05A408S	85
S04H3125S	56	S04H6124	63	S04H6450	64	S05A416S	85
S04H3141S	56	S04H6127	63	S04H6456	64	S05A4H10	83
S04H3157S	57	S04H6128	63	S04H8115S	58	S05A4H12	83
S04H3157SP	29	S04H6130	63	S04H8355	65	S05A4H14	83
S04H3194SV	33	S04H6132	63	S04H8360	65	S05A4H17	83
S04H3536S	57	S04H6134	63	S04H8365	65	S05A4H18	83
S04H3536SP	29	S04H6136	63	S04HD	Pág.	S05A4H19	83
S04H4108	62	S04H6138	63	S04HD2105	61	S05A4H4	83
S04H4109	62	S04H6141	63	S04HD2106	61	S05A4H5	83
S04H4110	62	S04H6146	63	S04HD2107	61	S05A4H6	83
S04H4111	62	S04H6150	63	S04HD2108	61	S05A4H7	83
S04H4112	62	S04H6152	63	S04HD2109	61	S05A4H8	83
S04H4113	62	S04H624101S	59	S04HD2110	61	S05A6105S	85
S04H4114	62	S04H6319	64	S04HD2111	61	S05A6H14	85
S04H4115	62	S04H6321	64	S04HD2112	61	S05A6H17	85
S04H4116	62	S04H6321S	57	S04HD2113	61	S05A6H19	85
S04H4117	62	S04H6322	64	S04HD3109	62	S05A6H22	85
S04H4118	62	S04H6323	64	S04HD3110	62	S05A6H24	85
S04H4119	62	S04H6324	64	S04HD3111	62	S05H	Pág.
S04H4120	62	S04H6325	64	S04HD3112	62	S05H4113S	66
S04H4121	62	S04H6326	64	S04HD3113	62	S05H4213S	66
S04H4122	62	S04H6327	64	S04HD3114	62	S05HD	Pág.
S04H4123	62	S04H6329	64	S04HD3115	62	S05HD4110	65
S04H4124	62	S04H6330	64	S04HD3116	62	S05HD4111	65
S04H4125	62	S04H6332	64	S04HD3117	62	S05HD4112	65
S04H4125S	57	S04H6334	64	S04HD3119	62	S05HD4113	65
S04H4125SP	29	S04H6336	64	S04HD3120	62	S05HD4113S	66
S04H4126	62	S04H6338	64	S04HD3121	62	S05HD4117	65
S04H4127	62	S04H6341	64	S04HD3124	62	S05HD4118	65
S04H4128	62	S04H6346	64	S04HD4109	63	S05HD4119	65
S04H4129	62	S04H6350	64	S04HD4110	63	S05HD4120	65
S04H4130	62	S04H6355	64	S04HD4111	63	S05HD4121	65
S04H4131SP	30	S04H6356	64	S04HD4112	63	S05HD4122	65
S04H4132	62	S04H6360	64	S04HD4113	63	S05HD4123	65
S04H4134	62	S04H6365	64	S04HD4114	63	S05HD4124	65
S04H4136	62	S04H6419	64	S04HD4115	63	S05HD4127	65
S04H4144KV	36	S04H6421	64	S04HD4116	63	S05HD4130	65
S04H42165SV	33	S04H6422	64	S04HD4117	63	S05HD4132	65
S04H4295SV	33	S04H6424	64	S04HD4118	63	S05HD4213S	66

S06A	Pág.	S07H225	69	S09H307	70	S10H360	72
S06A408S	85	S07H227	69	S09H308	70	S10H370	72
S06A4T20	85	S07H230	69	S09H310	70	S10H380	72
S06A4T27	85	S07H240	69	S09H312	70	S10H4100	72
S06A4T30	85	S07H310	69	S09H314	70	S10H4110	72
S06A4T40	85	S07H315	69	S09H404	71	S10H4120	72
S06A4T45	85	S07H320	69	S09H405	71	S10H480	72
S06A4T50	85	S07H325	69	S09H406	71	S10H490	72
S06A4T55	85	S07H327	69	S09H407	71	S11H	Pág.
S06A4T60	85	S07H330	69	S09H408	71	S11H200	72
S06A4T70	85	S07H340	69	S09H410	71	S11H201	72
S06A4T80	85	S07H345	69	S09H4109S	58	S11H202	72
S06H	Pág.	S07H350	69	S09H4118SP	30	S11H203	72
S06H204	68	S07H355	69	S09H412	71	S11H300	72
S06H205	68	S07H360	69	S09H414	71	S11H301	72
S06H206	68	S07H4109S	58	S09H416	71	S11H302	72
S06H207	68	S07H420	69	S09H417	71	S11H303	72
S06H208	68	S07H425	69	S09H419	71	S11H304	72
S06H210	68	S07H427	69	S09H4304	71	S11H402	72
S06H211	68	S07H430	69	S09H4305	71	S11H403	72
S06H306	68	S07H4320	70	S09H4306	71	S11H404	72
S06H307	68	S07H4325	70	S09H4307	71	S12A	Pág.
S06H308	68	S07H4327	70	S09H4308	71	S12A4525S	86
S06H310	68	S07H4330	70	S09H4309	71	S14A4108S	104
S06H311	68	S07H4340	70	S09H4310	71	S14A4117	104
S06H312	68	S07H4345	70	S09H4312	71	S14A4118	104
S06H314	68	S07H4350	70	S09H4314	71	S14A4120	104
S06H316	68	S07H4352	70	S09H4316	71	S14A4121	104
S06H318	68	S07H4355	70	S09H4317	71	S14A4123	104
S06H320	68	S07H4360	70	S09H4319	71	S14A4124	104
S06H37S	66	S07H4370	70	S09V	Pág.	S14A4126	104
S06H410	68	S07H440	69	S09V3H4	120	S14A4127	104
S06H411	68	S07H445	69	S09V3H5	120	S15H	Pág.
S06H412	68	S07H450	69	S09V3H6	120	S15H240	75
S06H4127S	58	S07H4530	73	S09V3H8	120	S15H356	75
S06H414	68	S07H4540	73	S09V41H10	120	S15H472	75
S06H416	68	S07H4545	73	S09V41H4	120	S15H6109	75
S06H418	68	S07H455	69	S09V41H5	120	S16H	Pág.
S06H420	68	S07H460	69	S09V41H6	120	S16H1234	75
S06H422	68	S07H470	69	S09V41H8	120	S16H1238	75
S06H424	68	S07H4932S	58	S10H	Pág.	S16H1438	75
S06H425S	58	S08H	Pág.	S10H230	71	S16H302	75
S06H427KV	36	S08H208S	103	S10H235	71	S16H304	75
S06H427SP	30	S08H311S	73	S10H240	71	S16H3410	75
S06H49S	66	S09H	Pág.	S10H245	71	S16H3412	75
S07H	Pág.	S09H203	70	S10H250	71	S16H3812	75
S07H206	69	S09H204	70	S10H255	71	S16H3814	75
S07H207	69	S09H205	70	S10H260	71	S16H403	75
S07H208	69	S09H206	70	S10H270	71	S17H	Pág.
S07H209	69	S09H207	70	S10H3100	72	S17H3116	75
S07H210	69	S09H303	70	S10H3120	72	S17H3121	75
S07H2138KV	36	S09H304	70	S10H340	72	S17H3414	76
S07H215	69	S09H305	70	S10H350	72	S17H4116	75
S07H220	69	S09H306	70	S10H355	72	S17H4121	75

S18A	Pág.	S24H6100	76	S46T	Pág.	S63H4313	73
S18A4103MS	86	S24H6200	76	S46TE80	87	S63H4405	73
S18A4115	87	S24H6400	76	S49H	Pág.	S63H4406	73
S18A4117	87	S24H8200	76	S49H4105	73	S63H4407	73
S18A4117M	86	S25V	Pág.	S49H4106	73	S63H4408	73
S18A4119	87	S25V310	121	S49H4108	73	S63H4409	73
S18A4119M	86	S25V36	121	S49H4110	73	S63H4410	73
S18A4121	87	S25V410	121	S49H4112	73	S63H4412	73
S18A4121M	86	S25V45	121	S49H4114	73	S63H4413	73
S18AD	Pág.	S26H	Pág.	S49H4116	73	S63H4414	73
S18AD4103S	87	S26H2150	77	S49H4308	73	S63H4507S	74
S18AD4117	87	S26H2280	77	S49H4310	73	S63H4605	74
S18AD4119	87	S27H	Pág.	S49H4312	73	S63H4606	74
S18AD4121	87	S27H2	77	S49H4314	73	S63H4607	74
S21H	Pág.	S27H3	77	S49H4318	73	S63H4608	74
S21H41125	76	S27H4	77	S50H	Pág.	S63H4609	74
S21H41250	76	S29H	Pág.	S50H3106S	73	S63H4610	74
S21H4150	76	S29H2133S	103	S50H3206S	73	S63H4612	74
S21H4175	76	S29H2180S	107	S54H	Pág.	S63H4613	74
S22H	Pág.	S29H4140SP	30	S54H5509S	73	S63H4614	74
S22H21150	76	S29H4141KV	36	S57H	Pág.	S63H4708	74
S22H21130RK	76	S29T	Pág.	S57H108	52	S63H4709	74
S22H313T	76	S29TP23S	103	S57H108S	52	S63H4710	74
S22H31200	76	S40H	Pág.	S57H109	52	S63H4712	74
S22H31200RK	76	S40H108	77	S57H110	52	S63H4713	74
S22H41375	76	S40H110	77	S57H111	52	S63H4714	74
S22H41375RK	76	S40H112	77	S57H112	52	S63H4808	74
S22H41450	76	S40H114	77	S57H113	52	S63H4809	74
S22H41600	76	S40T	Pág.	S57H115	52	S63H4810	74
S22H41600RK	76	S40T108	77	S57H116	52	S63H4812	74
S22H424T	76	S40T109S	77	S57H117	52	S63H4813	74
S22H6500	76	S40T110	77	S57H118	52	S63H4814	74
S22H6500RK	76	S40T112	77	S57H119	52	S64A	Pág.
S23H	Pág.	S40T113	77	S57H121	52	S64A4106S	85
S23H21115	76	S40T114	77	S57H122	52	S64A6116	86
S23H31200	76	S40T117	77	S57H123	52	S64A6118	86
S23H41250	76	S40T119	77	S57H124	52	S64A6306S	86
S23H41300	76	S40TB-1	77	S57H125	52	S64A6T70	86
S23H6450	76	S41H	Pág.	S57H127	52	S64A6T90	86
S23H6500	76	S41H41	77	S57H132	52	S64H	Pág.
S23H8550	76	S42M	Pág.	S60H	Pág.	S64H4104	74
S24H	Pág.	S42M403S	77	S60H4304S	78	S64H4105	74
S24H2100	76	S42M4125	77	S63H	Pág.	S64H4106	74
S24H2150	76	S42M4250	77	S63H3306	73	S64H4107	74
S24H250	76	S42M475	77	S63H3307	73	S64H4109	74
S24H3150	76	S43V	Pág.	S63H3308	73	S64H4112	74
S24H3200	76	S43V38	117	S63H3310	73	S64H4113	74
S24H3250	76	S43V48	117	S63H4132S	58	S64H4114	74
S24H375	76	S44H	Pág.	S63H4306	73	S64H4126S	58
S24H4125	76	S44H2206	78	S63H4307	73	S64H4204	74
S24H4224	76	S44H3110A	78	S63H4308	73	S64H4205	74
S24H4250	76	S44H3206	78	S63H4310	73	S64H4206	74
S24H450	76	S44H4110	78	S63H4312	73	S64H4207	74
S24H475	76						

S64H4208	74	S66HD4121	67	T15	Pág.	T29	Pág.
S64H4209	74	S66HD4122	67	T154100N-R	44	T29002	42
S64H4210	74	S66HD4123	67	T154200N-R	44	T29014	42
S64H4212	74	S66HD4124	67	T16	Pág.	T29016	42
S64H4214	74	S66HD4127	67	T16005N-R	44	T30	Pág.
S64H4216	74	S66HD4130	67	T19	Pág.	T30200NS	42
S64H4218	74	S66HD4132	67	T19135N	43	T31	Pág.
S64H4705	74	S68H	Pág.	T19200N	43	T31313	42
S64H4706	74	S68H2103	55	T19600N	43	T31324	42
S64H4708	74	S68H2104	55	T21	Pág.	T31332	42
S64H4709	74	S68H21045	55	T21025N	42	T33	Pág.
S64H4710	74	S68H2105	55	T21025N-R	44	T33025N	43
S64H4712	74	S68H21055	55	T21050N	42	T33025N-R	44
S64H4714	74	S68H2106	55	T21050N-R	44	T33050N	43
S64H4808	74	S68H21065	55	T211000N	42	T33050N-R	44
S64H4810	74	S68H2107	55	T211000N-R	44	T33101N	43
S64H4812	74	S68H2108	55	T21101N	42	T33101N-R	44
S64H4814	74	S68H2108	55	T21101N-R	44	T33200N	43
S66H	Pág.	S68H2109	55	T21200N	42	T33200N-R	44
S66H4108	66	S68H2110	55	T21200N-R	44	T33341N	43
S66H4109	66	S68H2111	55	T21340N	42	T33341N-R	44
S66H4110	66	S68H2112	55	T21340N-R	44	T35	Pág.
S66H4111	66	S68H2113	55	T21341N	42	T351060	46
S66H4112	66	S68H2114	55	T21341N-R	44	T41	Pág.
S66H4113	66	S68H2141S	54	T21550N	42	T41-SK	43
S66H4114	66	S68H4127S	54	T21550N-R	44	T41200N	43
S66H4115	66	S68H5234111S	55	T24	Pág.	T41200N-R	44
S66H4116	66	T04	Pág.	T24135	43	T41340N	43
S66H4117	66	T04M060-R	44	T24135-R	44	T41340N-R	44
S66H4118	66	T04M061-R	44	T24200	43	T47	Pág.
S66H4119	66	T04M150-R	44	T24200-R	44	T47010N	42
S66H4120	66	T04M250-R	44	T25	Pág.	T47020N	42
S66H4121	66	T07	Pág.	T25100N	42	T47021N	42
S66H4122	66	T07030N-R	44	T25100N-R	44	T47060N	42
S66H4124	66	T07110N-R	44	T25200N	42	T47101N	42
S66H4125	66	T07700N-R	44	T25200N-R	44	T47200N	42
S66H4126	66	T09	Pág.	T25340N	42	T47340N	42
S66H4127	66	T094602	45	T25340N-R	44	TV	Pág.
S66H4128	66	T094602-RK	45	T27	Pág.	TV01050N	117
S66H4128	66	T096801	45	T27-D2R	44	V10	Pág.
S66H4130	66	T096801-RK	45	T27-D3R	44	V1001	93
S66H4132	66	T10	Pág.	T27-D4R1	44	V1002	93
S66H4136	66	T102001S-R	44	T27-D4R2	44	V1002-RK	93
S66HD	Pág.	T10314	42	T27-D6R	44	V1003	93
S66HD4110	67	T10315	42	T27-D8R	44	V1003-RK	93
S66HD4111	67	T10316	42	T27010N	42	V1005	93
S66HD4112	67	T10317	42	T27020N	42	V11	Pág.
S66HD4113	67	T10318	42	T27021N	42	V11011SC	38
S66HD4114	67	T10319	42	T27060N	42	V1103	93
S66HD4115	67	T10321	42	T271001N	42	V13	Pág.
S66HD4116	67	T10322	42	T27101N	42	V1310A-11	94
S66HD4117	67	T10322	42	T27200N	42	V1310B-11	94
S66HD4118	67	T10H1210S	42	T27340N	42	V1310E-11	94
S66HD4119	67	T14	Pág.	T27800N	42	V1310F	94
S66HD4120	67	T14200N	43				

V1310F-11	94	W23V111	121	W251922	50	W26125	51
V1310G-11	94	W23V112	121	W252022	50	W26126	51
V1310J-11	94	W23V113	121	W252123	50	W26126S	51
V1311A	94	W23V114	121	W252224	50	W26127	51
V1311C	94	W23V116	121	W252426	50	W26128	51
V1311E	94	W23V117	121	W252427	50	W26129	51
V1311SP	31	W23V118	121	W252528	50	W26130	51
V14	Pág.	W23V119	121	W252730	50	W26132	51
V1401	94	W23V121	121	W252732	50	W26134	51
V1403	94	W23V122	121	W253032	50	W26134SV	34
V15	Pág.	W23V124	121	W253236	50	W26136	51
V1501	94	W24	Pág.	W253641	50	W26138	51
V1505	94	W240809	50	W253842	50	W26141	51
V21	Pág.	W241011	50	W254146	50	W26142	51
V2101	93	W241012	50	W254650	50	W26144	51
V2102	93	W24106S	50	W25V108	121	W26146	51
V2102-RK	93	W241213	50	W25V109	121	W26148	51
V24	Pág.	W241214	50	W25V110	121	W26150	51
V2401	93	W241314	50	W25V1125SV	121	W26155	51
V2401-M10A	93	W241417	50	W25V113	121	W26160	51
V2401-M10B	94	W241617	50	W25V114	121	W26165	51
V2401-M5A	93	W241719	50	W25V117	121	W2623431SV	34
V2401-M5B	94	W241819	50	W25V118	121	W26315SV	34
V2401-M6A	93	W241922	50	W25V119	121	W26411PRS	51
V2401-M6B	94	W242224	50	W25V121	121	W26414S	51
V2401-M8A	93	W242427	50	W25V122	121	W27	Pág.
V2401-M8B	94	W242528	50	W25V124	121	W27AK8	54
W10	Pág.	W243032	50	W26	Pág.	W27AL10	54
W106115SP	31	W24A107S	46	W26106	51	W27AR10	53
W23	Pág.	W24A109SP	31	W26107	51	W27AR8	53
W230607	50	W24N0810	50	W26108	51	W27AS10	53
W230809	50	W24N1113	50	W26108KV	37	W27AS15	53
W230810	50	W24N1214	50	W26109	51	W27AS18	53
W231011	50	W24N1719	50	W26110	51	W27AS8	53
W23108S	49	W25	Pág.	W26110KV	37	W27AT02SC	38
W23108SP	31	W250607	50	W26111	51	W27AT10	53
W231113	50	W250608	50	W26112	51	W27AT12	53
W231213	50	W250809	50	W26112S	50	W27AT15	53
W231317	50	W251011	50	W26112SP	31	W27AT8	53
W231415	50	W251012	50	W26113	51	W28	Pág.
W231617	50	W25106KV	37	W26114	51	W2808	54
W231719	50	W25107KV	37	W26114S	51	W2810	54
W231819	50	W25108S	50	W26115	51	W2810RJ-HL	54
W231922	50	W25110KV	37	W26116	51	W2812	54
W232022	50	W25110SP	31	W26116KV	37	W2812RJ-HL	54
W232123	50	W25117SC	38	W26116SP	31	W2814	54
W232224	50	W251213	50	W26117	51	W2814RJ-HL	54
W232426	50	W251214	50	W26118	51	W2818	54
W232427	50	W251415	50	W26119	51	W2818RJ-HL	54
W232528	50	W251417	50	W26120	51	W2824	54
W233032	50	W251617	50	W26121	51	W2824RJ-HL	54
W23559SV	34	W251618	50	W26122	51	W2836	54
W23V108	121	W251719	50	W26123	51	W2836RJ-HL	54
W23V110	121	W251819	50	W26124	51	W28HD8	54

W29	Pág.	W51	Pág.	W66121	48	W77A127	53
W290608	51	W51110S	47	W66124	48	W77A132	53
W290711	51	W52	Pág.	W67	Pág.	W77A136	53
W291012	51	W52105S	47	W67104S	48	W77A138	53
W291418	51	W61	Pág.	W67119	53	W77A141	53
W291622	51	W611011	49	W67121	53	W77A146	53
W292024	51	W61106S	49	W67124	53	W77A150	53
W39	Pág.	W611214	49	W67130	53	W77A155	53
W391011	51	W611315	49	W67132	53	W77A160	53
W39108SA	51	W611618	49	W67136	53	W77A165	53
W391213	51	W611719	49	W67138	53	W77H01	53
W391415	51	W612224	49	W67141	53	W77H02	53
W391617	51	W62	Pág.	W67145	53	W77H03	53
W391819	51	W6210607	49	W67146	53	W77H04	53
W43	Pág.	W6210809	49	W67150	53	W84	Pág.
W43A0607	52	W62108S	49	W67155	53	W84106	55
W43A0809	52	W6211011	49	W67160	53	W84107	55
W43A1011	52	W6211213	49	W67165	53	W84108	55
W43A106S	52	W6211415	49	W67170	53	W84108S	55
W43A1213	52	W6211617	49	W68	Pág.	W84109	55
W43A1415	52	W6211819	49	W680809	48	W84110	55
W43A1617	52	W6212022	49	W680810	48	W84111	55
W43A1819	52	W6212427	49	W681011	48	W84112	55
W45	Pág.	W6212528	49	W68106S	48	W84113	55
W45108	46	W6213032	49	W681213	48	W84114	55
W45109	46	W65	Pág.	W681415	48	W84114S	55
W45110	46	W65105KV	37	W681618	48	W84115	55
W45110S	46	W6510810	52	W681719	48	W84116	55
W45111	46	W6511012	52	W69	Pág.	W84117	55
W45112	46	W6511315	52	W69116S	52	W84118	55
W45112SP	31	W6511417	52	W70	Pág.	W84119	55
W45113	46	W6511922	52	W70A118S	31	W86112S	55
W45114	46	W65A1012	52	W72	Pág.	W91	Pág.
W45115	46	W65A105S	52	W72117	53	W91107S	48
W45116	46	W65A1214	52	W72118	53	W91110	49
W45117	46	W65A1315	52	W72119	53	W91112	49
W45117S	46	W65A1618	52	W72121	53	W91113	49
W45118	46	W65A1719	52	W72122	53	W91114	49
W45119	46	W65A1922	52	W72124	53	W91115	49
W45121	46	W65A2224	52	W72127	53	W91117	49
W45122	46	W66	Pág.	W72130	53	W91119	49
W45124	46	W66107S	47	W72132	53	W93	Pág.
W45127	46	W66108	48	W72134	53	W93108S	49
W45130	46	W66109	48	W72136	53	W93110	49
W45132	46	W66110	48	W72141	53	W93111	49
W45316S	47	W66111	48	W72146	53	W93112	49
W45316S-AD	47	W66112	48	W72150	53	W93113	49
W45316S-AD12	47	W66113	48	W72155	53	W93114	49
W45316S-AD14	47	W66114	48	W72170	53	W93115	49
W45316S-AD34	47	W66115	48	W73	Pág.	W93117	49
W45316S-AD38	47	W66116	48	W73102S	48	W93119	49
W45316S-ADBH14	47	W66116S	47	W7310813	48	WFS	Pág.
W47	Pág.	W66117	48	W7311419	48	WFS46	53
W47108SP	31	W66118	48	W77	Pág.	WV2	Pág.
		W66119	48	W77A124	53	WV27AS10	121

ARTIGO	PÁG.	ARTIGO	PÁG.
Acessórios de ar comprimido	189 a 191	Chave inglesa	53
Acessórios para carros ferramenta	22 e 23	Chave luneta	48; 49; 50; 51; 52
Alavancas de chapeiro	164	Chave mista	50; 51
Alicate anéis de segurança	139	Chave com roquete	46 a 48
Alicate ajustável	88; 90; 91	Chave para bujão óleo	140; 142
Alicate anti estático	92	Chave pata de galo	78
Alicate corta cabos	92; 93	Chaves alternador	135
Alicate de cravar terminais	94	Chave cavilhas e encaixes plásticos	163; 164
Alicate de descarnar	91; 94	Chaves de caixa	61 a 67
Alicate de freios	88; 89; 90	Chaves de fenda	97 a 101
Alicate de pressão	94; 95; 96	Chaves de filtros	140; 142
Alicate de rebitar	93	Chaves de impacto	78 a 87
Alicate para abraçadeiras	136; 139; 150; 151	Chaves de velas incandescência	137
Alicates (universal, pontas, corte)	88 a 92	Chaves dinamométricas	42; 43
Alicates para tubos	139; 145; 147	Chaves em L hexagonais	107 a 111
Alicate para tubos escape	148	Chaves em L Torx	107 a 110
Alicate para tubos radizador	151	Chaves em T com ponta flexível	77
Alicate tensor abraçadeiras	147	Chave flexível de punho	77
Alicates travões	146	Chaves Phillips	97 a 99
Apalpa folgas	144	Chaves Pozi	99; 101
Aparafusadora pneumática	176; 177	Chave remoção frisos/ plásticos	162; 163
Aparadeira óleo	124; 203	Chave remoção vidros/ pábrabras	162
Assentador pneumático de válvulas	184	Chaves retirar fêmeas danificadas	104
Balanceros	188	Chave de rodas em cruz	131
Bancada de trabalho	203	Chaves sensor oxigénio	143
Banco de apoio	201	Chaves SuperTech	54; 55
Bandeja magnética	130	Chaves Torx	99
Berberquim pneumático	175; 176	Chaves Torx plus	103
Bits de caixa	68 a 74	Chave para terminais	134
Bits e porta bits	105 a 107	Compasso	116
Bomba de massa	188	Compressor molas	128
Bomba hidropneumática	200	Corta tubos	148; 149
Cabo articulado (rabo de força)	76	Cunhas chapeiro	164
Cabo T corrediço	76	Densímetro	150
Cabos arranque de bateria	150	Desandadores	165; 166
Caixas de ferramenta	54 a 60	Despolidor de cilindros	149
Caneta magnética	130	Detetor de fugas cilindros	129
Cardan	75	Encontrador de chapeiro	164; 165
Carros e caixas vazios	19 a 21	Enroladores de ar	189
Carros e composições de ferramenta	7 a 18	Estrado de mecânico	201
Centrador embraiagens	147	Esquadro metálico	116
Chave bocas	50	Extensões	76; 78
Chave de barra direção	148	Extratores	126
Chave de bocas perfil fino	51	Extrator de juntas	135
Chave de cachimbo	52	Faca pneumática	185
Chave de injetores	138	Ferramenta ajuste eixo traseiro	148
Chave de pancada (bocas e luneta)	53	Ferramenta isolada 1000Volts	117 a 121
Chave de tubos	54	Ferramenta para correias	144
Chave de tubos combustível	139	Ferramenta para travões	146
Chave de velas	75; 143	Ferramenta rodar válvulas	138

ARTIGO	PÁG.	ARTIGO	PÁG.
Ferramentas chapeiro	162 a 167	Porta bits	107
Ferramentas especiais mecânica	124 a 160	Porta caçonetos	132
Ferramentas especiais motas	161; 162	Preguiças	124; 202
Ferramentas especiais pesados	167; 168	Prensas de chapeiro	202
Ferramentas especiais por marca	152 a 157	Punções	113; 114
Ferro de desmonta	148	Punho para chave caixa	77
Filtros de ar	190; 191	Raspadores/ riscadores	138, 139
Fita métrica	115	Rebarbadora pneumática	178
Funil para óleos e refrigerante	144	Rebitadora pneumática	187; 188
Gambiarra sem fios	131	Rectificadora pneumática	177; 178
Grampo segmentos	135	Reduções	75
Grampo válvulas	135	Refratómetro	128
Grua hidráulica	201	Régua metálica	116
Jogo de bits	102; 103	Régua verificação empenos motor	133
Jogo chaves caixa com roquete	56 a 58	Reparador de roscas	144; 145
Kit comando motores	133; 134; 152 a 159	Roquete pneumático	174; 175
Kit remoção de rádios	151	Roquetes	43 a 45
Limas	115	Saca casquilhos	130
Lixadora pneumática	179 a 181	Saca injectores	137; 155
Macaco de chapeiro	202	Sacas	126; 128
Macaco de fossa/ transmissões	200	Sangrador travões	125; 139
Macaco de rodas/ hidropneumático	201	Seringa	129
Machos e caçonetos	26; 38; 132	Serra	185
Mala de electricista	150	Serra pneumática	184
Mala de ferramenta	58 a 60	Suporte de motores	201
Máquina decapar pneumática	185	Suporte movimentação rodas/pneus	201
Máquina descavar pneumática	177	Suporte para chaves caixa	74
Máquina pneumática impacto	170 a 173	Tabuleiros ferramenta (caixa plástico)	26 a 31
Martelo pneumático	187	Tabuleiros ferramenta (EVA)	32; 37
Martelos	112	Tabuleiros vazios	39 a 41
Martelos de chapeiro	165	Tesoura	92
Medidor angular de torque	131	Tesoura pneumática	186
Medidor discos travão	149	Teste atuadores	150
Medidor de passo de rosca	131	Teste compressão/ pressão	136
Medidor de profundidade	149	Teste de vácuo/ pressão	139
Medidor de pressão pneus	130	Teste fluido travões	150
Merchandising	194 a 197	Teste fluxo e retorno injectores	136
Micrómetro	116	Teste pressão radiadores	124
Molas de plástico	164	Teste turbo	137
Multímetros	203	Tira mossas	165; 166
Organizador de peças	135	Tomadas de ar	191
Paquímetro	116	Torno de bancada	23
Pesca magnético	130	Travessa para portas	202
Pinça amperimétrica	203	Travessa para motores	202
Pinças de chapeiro	166	Tubo espiral para ar	191
Pistola de pintura	182; 183	Turquês	92
Pistola vaporizadora (tornado)	129	Ventosas	163
Pistoletes ar/ água	189	Verificador altura calços travão	147
Polidora pneumática	179; 180	X-ato/ navalha	115
Ponteira para válvula pneus	130; 131		



Com ferramentas pneumáticas não utilizar chaves de caixa, juntas universais ou outras ferramentas de uso manual.



Não utilizar martelos ou tubos para aumentar o binário em chaves de aperto, chaves dinamométricas e roquetes.



Não utilizar chaves de parafusos como alavanca, punção ou escopro. Existem séries especiais de chaves de parafusos que podem ser marteladas.

Ferramentas Manuais

- Deverá ter bastante cuidado ao utilizar qualquer ferramenta, mantendo-a afastada das crianças.
- Recomenda-se utilizar sempre máscaras, óculos, auriculares e luvas de proteção (se aplicável).
- Deverá desligar sempre a energia elétrica antes de efetuar trabalhos em qualquer tipo de máquina ou equipamento elétrico ou junto de superfícies condutoras, pois poderão ocorrer choques elétricos. Nestes casos, utilizar sempre ferramentas isoladas.
- Deverá escolher o tipo e tamanho correto da ferramenta para o trabalho a realizar. As unidades de medida servem para selecionar a ferramenta com tamanho certo.
- Deverá manter as ferramentas limpas.
- Deverá ler as instruções antes de utilizar as ferramentas.
- Não deverá modificar nenhuma ferramenta.
- Nos carro de ferramentas, nunca deverá abrir mais do que uma gaveta de cada vez (perigo de tombar).
- Nos carro de ferramentas, nunca deverá usar uma gaveta como escada (perigo de tombar).
- Não deverá puxar de costas o carro de ferramentas.

Ferramentas Pneumáticas

As ferramentas pneumáticas Jonnesway permitem que os operadores usufruam de uma utilização segura, um desempenho excelente e reduzidas vibrações. As seguintes instruções de segurança são para as condições normais de utilização. Antes de utilizar as ferramentas pneumáticas, deverá ler com atenção estes avisos para evitar perigos desnecessários.

• Utilizar Proteção Pessoal

Deverá usar sempre proteção (como por exemplo máscaras, óculos, auriculares, luvas, etc.) quando manusear ferramentas pneumáticas de modo a evitar ferimentos.

• Evitar Danos Causados por Vibrações ou Movimentos de Trabalho Repetitivos

A exposição prolongada a vibrações ou a movimentos de trabalho repetitivos poderá ser prejudicial. Se sentir formigueiro, entorpecimento, desconforto ou dor, deverá parar de utilizar a ferramenta de imediato. Os operadores deverão seguir sempre as instruções a seguir indicadas:

- Utilizar as pegadas do equipamento para garantir a sua rigidez e eficiência.
- Manter os pulsos o mais direito possível.
- Evitar movimentos muito repetitivos das mãos e pulsos.
- Manter as mãos e o corpo quentes e secos.
- Evitar a exposição contínua a vibrações por períodos muito prolongados.



• **Evitar os Perigos do Ar Comprimido**

- O ar sob pressão pode causar ferimentos. Por favor, observar as seguintes instruções de segurança para garantir um ambiente de trabalho seguro.
- Não direcionar o tubo do ar para si ou para outros. Deverá afastar o escape do ar de si próprio ou de outros.
- Antes de utilizar a ferramenta pneumática, verificar a existência de tubos e acessórios danificados ou soltos.
- Deverá desligar a ferramenta sempre que estiver a substituir acessórios, definir o aperto, efetuar reparações ou não estiver a ser utilizada.
- Deverá manter sempre a pressão do ar nos valores aconselhados, já que a utilização das ferramentas fora destes valores diminuirá o seu rendimento e a vida útil da ferramenta.
- Não ligar ferramentas pneumáticas a tomadas elétricas.
- Quando utilizar uniões universais de torção, deverão ser sempre instalados pinos/garfos de bloqueio para evitar que os tubos se desliguem acidentalmente.

• **Evitar Perigos Adicionais**

- Escorregadelas, tropeções e quedas são a causa principal de ferimentos e morte em acidentes de trabalho.
- Deverá ter cuidado com o excesso de tubos e cabos existentes na área de passagem ou na superfície de trabalho.
- Os operadores e técnicos de manutenção deverão estar fisicamente aptos para efetuar as suas tarefas e suportar o volume, peso e potência da ferramenta.
- Deverão ser utilizadas proteções nas rebarbadoras para reduzir o risco de cortes e escoriações devido às rebarbas.

Sistema Pneumático de Alimentação

- ① Filtro
- ② Drenagem
- ③ Secador de Ar
- ④ Depósito de Ar
- ⑤ Compressor de Ar
- ⑥ Filtro Regulador - Lubrificador

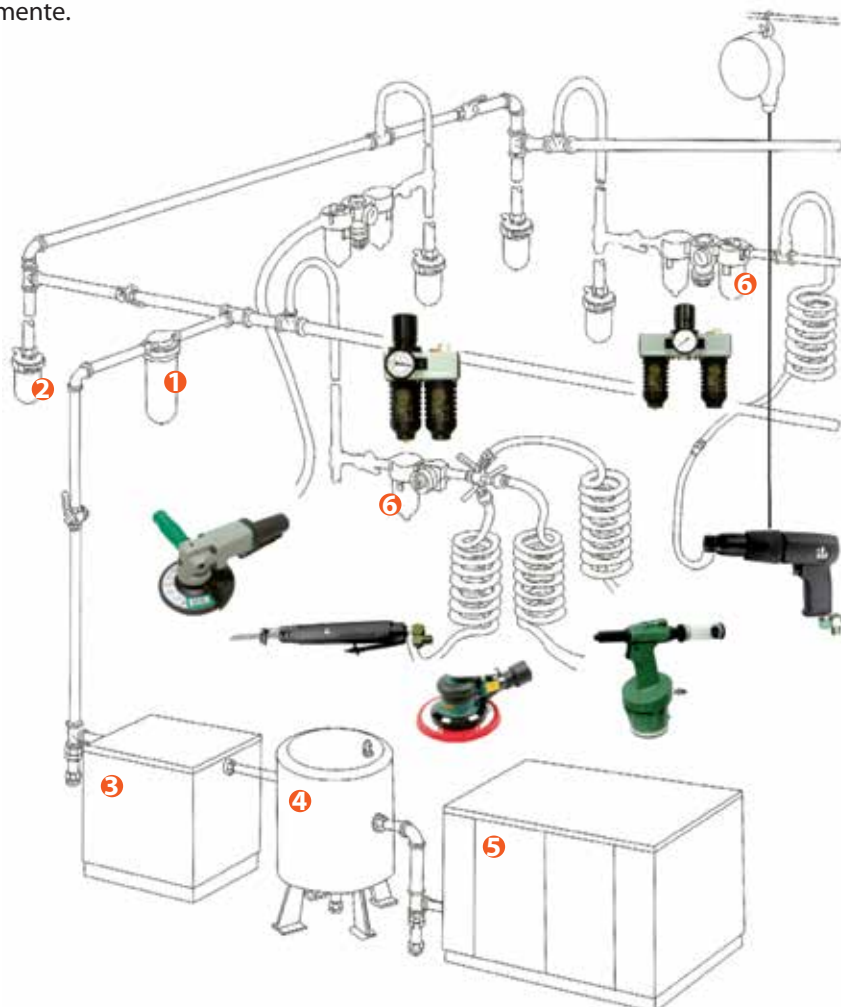

Recomendações de Manutenção

Quando ligar a ferramenta pneumática à rede de ar comprimido, deverá certificar-se que a pressão de alimentação desta deverá ser de 6.2kg/cm² (90PSI), já que se esta for demasiado elevada poderá danificar a ferramenta e se for demasiado baixa influenciará o funcionamento da mesma, reduzindo a sua vida útil.

- É recomendável a instalação dos filtros reguladores-lubrificadores adequados à ferramenta pneumática em uso. A entrada do ar deverá ter óleo lubrificante apropriado, de modo a lubrificar o motor interno da ferramenta. (Colocar um papel branco na saída do ar para verificar se existe uma sujidade gordurosa, que indique a existência de óleo suficiente).
- A entrada de ar não deverá ter água. Se tal ocorrer, recomenda-se a verificação ou instalação de um secador de ar.
- Não deverá desmontar a ferramenta, pois poderá danificá-la e afetar a segurança do utilizador.
- Mesmo que a ferramenta possua danos menores ou não efetue as funções indicadas pelo fabricante, não deverá utilizá-la até que seja inspecionada.
- Para manter o bom desempenho da ferramenta, deverá efetuar verificações regulares (semanalmente) e manutenções preventivas e lubrificações (adicionar massa lubrificante às peças rotativas e óleo lubrificante no motor).
- Sempre que utilizar as ferramentas pneumáticas deverá cumprir com as normas de segurança e instruções de funcionamento (quer aplicáveis à proteção do utilizador, quer à correta utilização da ferramenta).
- É essencial escolher as ferramentas certas e adequadas para o trabalho a realizar, já que se a ferramenta tiver uma potência muito elevada, poderá causar danos na peça em que está a trabalhar e se tiver pouca potência, poderá ficar danificada.

Condições Gerais de Garantia

A ferramenta manual e pneumática Jonnesway é fabricada com os mais elevados padrões de qualidade, mas é, para todos os efeitos, uma ferramenta de desgaste. É pois normal que a ferramenta sofra alteração de algumas características físicas durante o período de utilização, mesmo quando usada em condições normais. Assim, a garantia da ferramenta fica dependente do conjunto das seguintes condições gerais:

- Para ferramentas manuais é oferecida uma garantia de “vida útil”, garantia esta que cobre defeitos de materiais e fabrico. Entende-se como “vida útil” o período de tempo de vida expectável para a peça de ferramenta em causa, desde que utilizada sempre nas condições normais de utilização e para as quais foi concebida.
- A gama de ferramentas pneumáticas e ferramentas de medição estão excluídas do ponto anterior. Os produtos foram desenhados e fabricados para uso profissional. O período de garantia é de um ano (12 meses) para uso profissional e de dois anos (24 meses) para uso particular. O período de garantia inicia-se à data da aquisição. Esta data deve ser verificada mediante a fatura de aquisição.
- Qualquer produto que tenha sido utilizado ou mantido de forma incorreta, que tenha sofrido um desgaste devido a uma utilização inadequada ou que tenha sido sujeito a alterações não autorizadas, não está coberto pela garantia.
- A ausência de manutenção preventiva ou a utilização de ar comprimido com pressão e lubrificação desajustadas são motivo para a perda imediata da garantia.





Ferramentas Profissionais Manuais e Pneumáticas

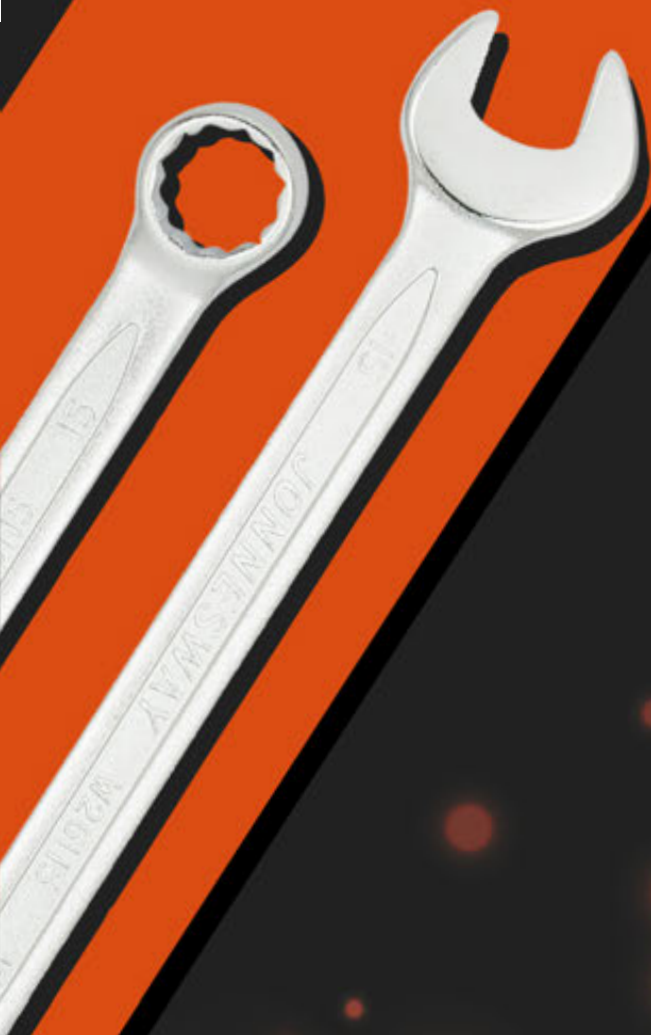

Distribuidor/ Revendedor

Importador para Portugal, França, Espanha, Angola e Cabo Verde



Rua Engº Ferreira Dias, 953/993 • 4100-247 • Porto
Tel. +351 226 198 750 • Email. lusilectra@lusilectra.pt
www.lusilectra.com • www.jonneswaytools.com